



**Wingo**®

PROFESSIONAL FOODSERVICE STANDARDS.  
PROFESSIONAL INDUSTRY CHOICE.

2017



# Welcome to

*We are dedicated to providing products for your busy kitchen that enhance the preparation, cooking and dining experience for operators and patrons.*

Winco® began in the foodservice industry with a truly unique arrival. As restaurant owners and operators based in New York City, our founders had difficulty finding quality **smallwares at reasonable prices.**

With a passion for the foodservice industry, they relied on their previous background in stainless steel distribution to offer better product solutions, for everyone. Winco's foundation is built on the idea that a smallwares and equipment suppliers must be able to **deliver quality products as well as partnership services.** These joint strengths combined with the passion for foodservice has made

Winco a leading brand in the industry.

Today, Winco is best known for **the ideal product mix**, offering exactly what restaurant operators need from front to back of the house. Our ever-growing product range, always carefully developed and curated, reflects our core vision: users deserve reliable, high-quality products without inflated pricing. Winco products are on-spec for their application, no more and certainly no less. Our quality control and consolidation centers overseas and in the U.S.A. ensure that **products live up to our promise**, while capturing the value of logistics efficiencies that we in turn pass on to our customers. Winco's team has also been awarded for some of the **best service**, delivery times and fill rates in the foodservice industry!

**For over 25 years you have allowed us to be your partner - Thank you. We look forward to continued growth together!**

## *Facilities in New Jersey and now in California!*

Our newest warehouse in CA houses over 180,000 Sq. Ft. of inventory, for even better stock availability. Conveniently located in La Mirada (*less than 20 miles south of Los Angeles*), Winco offers fast shipments to all of the West coast.



### WINCO SNAPSHOT

- ✓ Over 4,000 products
- ✓ 500,000 sq ft. distribution warehouses, 2 locations
- ✓ Over 200 employees
- ✓ Over 70 sales representatives covering North America



**Front of House**

*Dining & Service*

**15**

**Flatware**

**16**

- 18/8 Flatware
- 18/0 Flatware
- Hollow Handle Knives
- Steak Knives

**Buffet Service**

**34**

- Chafers & Accessories
- Chafing Fuel
- Coffee Urns
- Electric Water Pan
- Juice Dispensers
- Serving Trays & Utensils
- Signs-Clip, Chain, Tent
- Virtuoso™ Chafers**

**Tabletop Serveware**

**47**

- Condiment Dispensers & Sauce/Dessert Cups
- Fajita Servers & Sizzle Platters
- Glass Shakers & Caddies
- Maestro™ Pepper Mills**
- Mini Baskets & Cups
- Mini Cans & Pails
- Mini Cookware/Serveware
- Salad Bowls
- Salt Shakers
- Seafood Trays
- Serving Baskets- Plastic, Woven Poly, Wire
- Serving Boards & Trays
- Snail Server
- Sugar & Creamers
- Taco & Salsa/Dip Service
- Tortilla Presses

**Melamine Dinnerware**

**64**

**Dining Service**

**66**

- Cafeteria/Mess Trays
- Call Bells & Crumbers
- Cheese Knives
- Coat Check
- Condiment Dispenser
- Decorative Picks
- Display Boards & Easels
- Electric Tealights
- Flatware Organizers
- Graters, Zesters & Peelers
- Menu Covers & Stands
- Order Racks & Check Service
- Seafood/Snail Service
- Serving Trays & Stands
- Signs- Stanchion Floor Stands, LED, Information, Braille
- Squeeze Bottles
- Straw & Napkin Dispensers
- Table Covers
- Table Signs & Clips
- STABLEizer™ Wedges/Shims**
- Wine Service

**Beverage Service**

**86**

- Airpots & Racks
- Beverage Dispensers
- Coffee & Tea Accessories
- Coffee Warmers- Single, Double
- Cup & Lid Organizers/Racks
- Drip Trays
- French Press
- Insulated Servers
- Juice Dispensers
- Pitchers- Plastic, Stainless Steel
- Plastic Drinkware- Havana-style, Pebbled
- Punch Bowl
- Beverage Signs- Chain & Tent
- Virtuoso™ Coffee Urns**

**Display**

**96**

- Angled Adaptor
- Cake/Dessert Stands
- Display Cases/Covers
- Crocks & Covers-Plastic
- Display Boards & Easels
- Risers, Bowls & Trays- Acrylic, Plastic, S/S
- Roll-Top Cover

**Bar Supplies**

**101**

- Bar Clean-Up
- Bar Liners & Service Mats
- Bar Speed Rails
- Beer Mug Washer
- Accelmix™ Blender**
- Bottle Openers & Corkscrews
- Condiment Holders
- Drink Prep & Ice Tools
- Insulated Ice Caddy
- Muddlers & Squeezers
- Moscow Mule Mugs**
- Non-Slip Trays
- Overhead Glass Racks
- Pour Bottles
- Pourers & Stoppers
- Syrup/Liqueur Pump Kit
- Wine Service

**Kitchen**

*Prep & Cook*

**115**

**Professional Cutlery**

**116**

- ACERO™ Forged Cutlery**
- Cheese Knives, Wires, Graters
- Cook's/Pot Forks
- COOL HEAT™ Turners**
- Knife Storage/Transport
- Professional Cleavers
- Protective Gloves
- Sharpening Tools
- Shears-Poultry & Herb
- Specialty & Pizza Knives
- STAL™ Stamped Cutlery**
- Steak Knives

**Professional Cookware**

**133**

- Aluminum Cookware
- Cast Iron Skillets/Pans
- Cookware Accessories
- Fryer & Pasta Baskets
- Roasting Pans
- Stainless Steel Cookware

**Steam Table Pans**

**148**

- Adaptor Bars & Plates
- Bain-Maries & Insets
- False Bottoms
- Specialty Pans & Covers
- Water & Spillage Pans
- Wire Steam Pan Grates

**Poly Pans & Food Storage**

**154**

- Dough Boxes, Covers, Dolly
- Food Storage Containers- Round, Square, Clear, Translucent, White
- Drain Shelves
- Food Pans & Covers
- Ingredient Bins

**Bakeware**

**160**

- Baking Mats, Silicone
- Batter Dispensers & Funnels
- Cake Decorating Tools
- Cake Pans- Round & Rectangle
- Cookie Sheet & Cutters
- Cooling Racks & Grates
- Connoisseur™ Pastry Blender**
- Dough Preparation- Boxes, Proofing Pans, Dockers, Scrapers
- Doughnut Basket
- Dredges & Lids
- Leveler, Markers, Cutters
- Measuring Tools- Cups, Spoons & Ladles
- Mixing Tools- Paddles, Spoons & Bowls
- Muffin Pans
- Pastry Tools- Brushes, Blenders, Wheels, Cutters & Molds
- Rolling Pins
- Scrapers-Silicone & Plastic
- Spatulas
- Sheet Pans
- Sheet Pan Racks
- Sifters & Sieves
- Specialty Pans- Tart, Bundt & Bread Form
- Springform Pans
- Timers & Oven Mitts

**Pizza Supplies**

**181**

- Bubble Poppers
- Dough Preparation- Boxes, Sifter, Scrapers, Mixing Paddles, Rolling Pins
- Dredges & Lids
- Heat Sink
- Insulated Delivery Bags
- Mesh Screens
- Pizza Knives/Cutters
- Pizza
- Oven Brushes
- Perforated Disks
- Pan Grippers
- Pizza Pans- Round, Sicilian, Stackable, Deep Dish
- Stand & Rack
- Peels-Aluminum & Wood
- Servers & Tongs

**Food Prep**

**190**

- Commercial Can Openers
- Colanders
- Countertop Juice Squeezers
- Cutting Boards & Mats
- Dispensers- Batter & Condiment
- Food Mills
- Kattex™ Slicers & Cutters**
- Mandoline Slicers & Blades
- Manual Prep Tools
- Mixing Bowls & Stand
- Pasta Maker
- Salad Spinners
- Scales
- STAYGRIP™ Cutting Boards**
- Thermometers
- Tortilla Press
- Utility Pail

**Kitchen Utensils 207**

- Allergen-Free™ Tools**  
 Basting Covers & Utensils  
 Butter Roller  
 Cook's Forks  
 Culinary Baskets  
 Egg Tools  
 Fryer Accessories  
 Fruit Prep Tools  
 Funnels & Dispensers  
 Graters, Zesters & Peelers  
 Ladles & Dippers  
**Connoisseur™ Mashers**  
**Connoisseur™ Pasta Baskets**  
 Measuring Cups & Spoons  
 Meat Prep Tools
- Mixing/Stirring Paddles  
 Plating Molds & Utensils  
 Scoops & Rack  
 Scrapers, Plastic & Nylon  
 Serving Tongs-  
 Poly, Heat-Resistant &  
 Stainless Steel  
 Seafood Prep Tools  
 Shears, Herb & Poultry  
 Spatulas/Turners  
 Spoons, Nylon & Wood  
 Squeeze Bottles  
 Strainers & Skimmers  
 Whips, Stainless Steel  
**Winco Prime® Utensils**

**Textiles 244**

- Aprons, Bib & Waist  
 Bar & Kitchen Towels  
 Chef Hats-  
 Cloth & Disposable  
 Cotton Gloves
- Pan/Pot Holders  
 Oven Mitts  
**Signature Chef™ Apparel-**  
 Shirts, Pants, Jackets  
 Table Covers & Clip

**Back of House 249**  
*Clean & Organize*

**Janitorial 250**

- Brushes, Oven & Utility  
 Cleaning Accessories  
 First Aid Cabinet  
 Floor Care & Floor Mats  
 Gloves & Wall Brackets  
 Grill Maintenance
- Hood Filters  
 Insect Control  
 Janitorial Accessories  
 Restroom Necessities  
 Trash Cans, Lids, Dollies,  
 Receptacle & Wire Cart

**Shelving & Racks 263**

- Dunnage Racks  
 Wire Shelving & Sets

**Bussing & Transport 267**

- Bus/Dish Boxes & Carts  
 Casters, Universal  
 Dish/Tray Caddy
- Flatware Organizers  
 Hot/Cold Food Transporters  
 Sheet Pan Racks

**Equipment 275**  
*Cook & Merchandise*

**Countertop Equipment 276**

- Accelmix™ Blender**  
 Beverage Displays-  
 Refrigerated  
 Butane Gas Stove, Portable  
 Coffee Warmers-  
 Single, Double, Tiered  
 Convection Ovens  
**ShowTime!™ -**  
 Cotton Candy Machine,  
 Popcorn Poppers
- Deep Fryers  
 Food Cooker/Warmers  
 Heat Lamps  
 Heated Merchandisers  
 Induction Cooker  
**Panasonic® Rice Cooker**  
 Pizza Oven, Electric  
 Rice Cookers/Warmers  
 Sandwich Grills  
 Soup Merchandisers  
 Soup Warmers

**SPECTRUM 289**

- Electric  
 Gas

**Index 300**

**Icons/Symbols**

Look for these symbols throughout the catalog:



New product introduced since last catalog



Product is packed in display-ready retail packaging (color box, color blister pack, hang tag, etc.)

**Certifications**



Product is NSF® certified and complies with all food safety standards



Product is listed in the CSA® Group Certified Product Listing



Product is ETL™ certified for compliance with accepted national safety standards for USA and Canada



Product is ETL™ certified for compliance with sanitation/food safety standards



Product is UL® certified for compliance with safety standards



Product is UL® certified to be compliant with safety standards for U.S.A. and Canada



Energy Verified  
 Rendement  
 Énergétique Vérifié

Product is UL® certified to be compliant with energy efficiency standards



Product does not contain Bisphenol-A (BPA)



Product does not contain Perfluorooctanoic Acid (PFOA)



Product is compatible with induction cookers

**Most orders less than pallet loads will be shipped by UPS. Look for these shipping icons to guide freight evaluations.**



Additional oversize fee applies if item ships via UPS®



Item cannot be shipped by UPS®

## MINI TRI-PLY COOKWARE



Artfully present single-serve portions in copper and stainless steel finished tri-ply mini cookware.

- ◆ Tri-ply construction with either stainless steel or copper exterior, all induction ready
- ◆ Aluminum core provides efficient heat distribution
- ◆ 18/8 stainless steel cookware surface for superior cooking performance
- ◆ Available in 8 sizes

TRI-PLY INDUCTION READY



P.47

## MINI COOKING & SERVEWARE

Artfully cook and present single-serve portions in copper and stainless steel finish mini-ware.

- ◆ Various sizes available in each series
- ◆ Available in stainless steel and copper plated



P.48

## CARBON STEEL SERVE & COOKWARE



### CSPP-SERIES

These Spanish-made, carbon steel fry pans are ideal for adding a rustic look to fresh-cooked eggs or displaying individual Mediterranean dishes!

4-3/4" DIA. INDIVIDUAL SERVING SIZE



MADE IN SPAIN

P.49

## CAST IRON CASSEROLE WOK

### CSW-75

- ◆ Authentic cast iron wok in mini tabletop serving size
- ◆ 7"Dia x 2"H

NON-STICK



P.54

## OIL/VINEGAR CRUETS & CONDIMENT SET

### G-104S, GOB-16S

NOW AVAILABLE AS SETS

NEW SIZES



P.56

## MINI ROASTING PANS

### DDSB-SERIES

- ◆ Available in stainless steel and copper-plated



P.49

## MINI SUGAR PACKET HOLDER

### DDSG-SERIES

- ◆ Pieces sold individually or as a set



DDSG-301S (SET)

P.59

## STAINLESS STEEL SERVING TRAYS

### DDSI-, DDSH-SERIES

- ◆ Stylishly serve appetizers
- ◆ Both series available in 2 sizes



P.52

## MINI SERVEWARE

Artfully cook and present single-serve portions in copper and stainless steel finish mini-ware.



P.50, 51 & 102

## MINT JULEP CUPS

### DDSE-SERIES

- ◆ Available in 2 sizes
- ◆ Stainless steel



P.51 & 102

## MARBLE & WOOD SERVING BOARDS

### SBMW-SERIES

- ◆ Available in 3 sizes

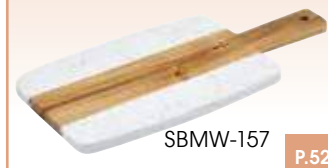

P.52

## CONDIMENT DISPENSER

### PKTS-2D

- ◆ Heavy-duty pump ideal for high-volume restaurant environment
- ◆ Two (2) plastic inserts with 2 quart capacity
- ◆ Each pump full stroke draws out between 1 Oz and 1-1/4 Oz depending on viscosity



P.58,  
74  
&195

## COUNTERFEIT DETECTION PEN

### PMM-2

- ◆ Fast and easy way to detect fraudulent bills
- ◆ Great for the busy retail or restaurant environment



P.77

## STACKABLE PLASTIC HIGH-CHAIR

### CHH-25

- ◆ Sturdy and durable polypropylene construction
- ◆ Plastic surface wipes clean after each use
- ◆ Snap-on tray included
- ◆ Assembly required
- ◆ Assembled size: 25-1/2"W x 23"D x 29-1/2"H



P.82

## COUNTERTOP ELECTRIC BLENDER

### XLB-1000

- ◆ High-performance motor with impact-resistant stainless steel blades

TRITAN™  
CONTAINER

**BPA FREE**



**ACCELMIX™**  
by Winco®

P.106  
&288

## GUEST ORDER HOLDER

### CHK-2K

- ◆ Fits 4-1/4" x 8" check size



P.77

## SINGLE VIEW MENU COVER

### LMS-414BK

- ◆ Fits 4-1/2" x 14" bar menu



P.66

## JAPANESE-STYLE JIGGERS

### J-SERIES

- ◆ Stainless steel
- ◆ Rolled rim for a high-end look
- ◆ Available in 4 sizes



J-7

P.103

## MIXING GLASS

### WG10-001

- ◆ 16 oz
- ◆ New lower price



P.102

## MINI WASTE CAN

### DDSF-101S

- ◆ 4-3/4"Dia x 6" H
- ◆ Stainless steel



P.78

## PATTERNED TABLE COVERS

### TBCS-SERIES

- ◆ New black color
- ◆ Available in 3 sizes

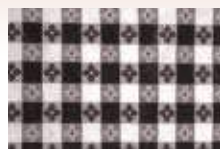

P.80  
&247

## WALL-MOUNT BOTTLE OPENER

### CO-402

- ◆ Made of sturdy die-cast zinc alloy



P.105

## ICE ONLY CONTAINERS

### FCW-SERIES

- ◆ Available in 10 Gal & 20 Gal

FCW-10ICE



P.107

## SYRUP DISPENSER LIDS

### PSUD-SERIES

PSUD-RLID

PSUD-TLID

**NEW COLORS**  
**BPA FREE**

P.59  
&233

## TWO-TIER GLASS RIMMER

### GR-SERIES

- ◆ Available in 2 sizes

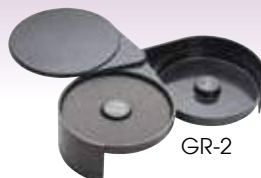

GR-2

P.103

## ICE CUBE TRAYS

### ICCT-SERIES

- ◆ Silicone material for easy removal
- ◆ Cubes also fit any standard Whiskey glass
- ◆ 2" Cubes
- ◆ Available in 2 sizes

ICCT-4R

ICCT-8R

P.106

## STÄL COLOR STAMPED CUTLERY

### KWP-SERIES

◆ Available in 8 different knife styles



KWP-80  
SERIES  
SHOWN



P.122  
&123

## HIGH-HEAT NYLON HANDLE TURNERS

### TNH-SERIES

**COOL  
HEAT** up to 500°F



P.128  
&226

## ACERO FORGED CUTLERY

### KFP-SERIES

Our Acero forged series offers exceptional commercial quality at never-before-seen prices.

**X50 CR MOV15  
GERMAN STEEL  
FULLY FORGED, FULL TANG  
UNIQUE POM HANDLE**

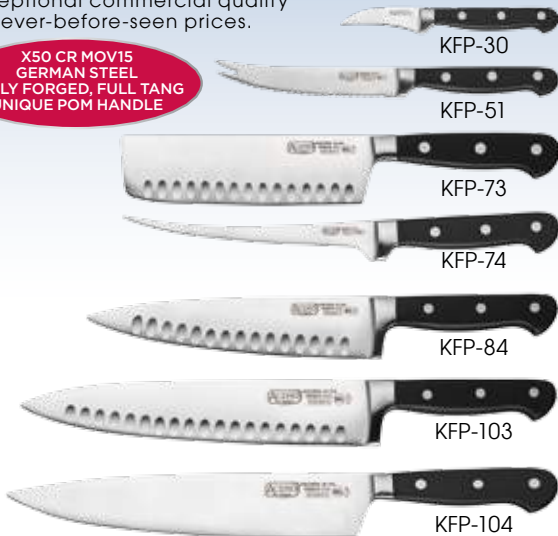

KFP-30

KFP-51

KFP-73

KFP-74

KFP-84

KFP-103

KFP-104

P.116-  
118

## STÄL STAMPED CUTLERY

### KWP-SERIES

Stäl series, our most economically priced line, offers the same level of quality and performance as others costing twice as much.

**X50 CR MOV15  
GERMAN STEEL  
HIGH CARBON  
STAIN RESISTANT**

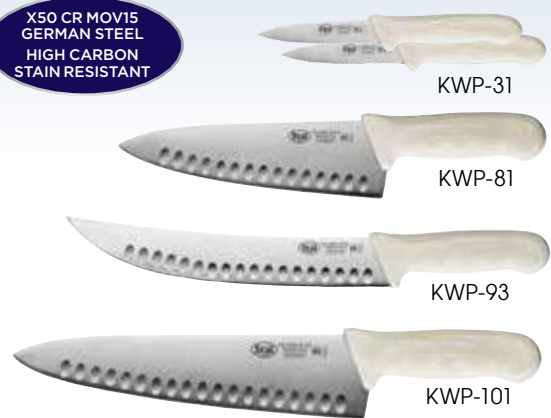

KWP-31

KWP-81

KWP-93

KWP-101

P.120  
&121

## HARD COVER KNIFE BAGS

### KBG-SERIES

**NEW &  
IMPROVED**



KBG-8 (8 Slots)



KBG-29 (29 Slots, Triple Zip)



KBG-11 (11 Slots)

P.127

## DETACHABLE KITCHEN SHEARS

### KS-06

- ◆ Shears come apart for easy cleaning and sharpening
- ◆ Handle has built-in bottle opener



P.125  
&238



## ACERO 7-PIECE KNIFE BLOCK SET

### KFP-BLKA

- ◆ 3.5" Paring Knife (KFP-35)
- ◆ 5" Utility Knife (KFP-50)
- ◆ 6" Boning Knife (KFP-61)
- ◆ 8" Chef Knife (KFP-80)
- ◆ 8" Bread Knife (KFP-82)
- ◆ 8" Sharpening Steel
- ◆ Wooden Knife Block
- ◆ Bonus Shears (KS-06)



KNIVES ONLY NSF



P.119

## FOUR-STAGE KNIFE SHARPENER

### KSP-4

- ◆ Reduced wobbling with oversized non-slip base
- ◆ For either standard or Asian style knives, coarse stages quickly sharpen dull knives, while fine stages hone to a razor sharp edge



P.125

## FRENCH-STYLE FRY PANS



### CSFP-SERIES

- ◆ High-quality carbon steel pan allows for long pre-heating at high temperatures; suitable for searing
- ◆ Riveted handle
- ◆ Available in 5 sizes



MADE IN SPAIN

P.136

## PAELLA PANS

### CSPP-SERIES

These Spanish-made carbon steel pas are ideal for the creation and display of authentic paella dishes, roasting meat, making stir-fry, and much more!

- ◆ Available in 3 enamel sizes
- ◆ Available in 5 polished sizes

MADE IN SPAIN

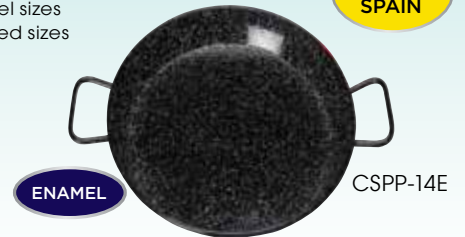

P.136

## DOUBLE ROASTER COMBINATION & BAKE/ROAST PANS

### ALRP-SERIES

- ◆ Made of heavy-duty 10/12 gauge aluminum

REINFORCED, IMPROVED FINISH



ALRP-1824L



ALRP-1826



ALRP-1826H

P.143

## PREMIUM STAINLESS STEEL OMELET PANS



### SSOP-SERIES

- ◆ Tri-ply heavy-duty bottom for even heat distribution
- ◆ Available in 5 sizes



SSOP-9

P.133

## HEAVY-DUTY ALUMINUM SHEET PANS

### ALXP-SERIES

- ◆ Closed bead with galvanized wire for rust resistance and reinforcement
- ◆ Made of 3003 aluminum

NEW HEAVY GAUGES

OTHER SIZES AVAILABLE

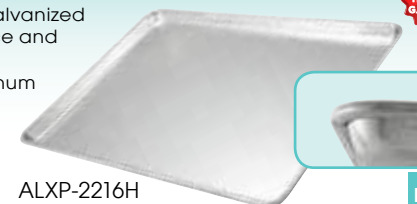

ALXP-2216H

P.160

Step up to

WINCO® PRIME UTENSILS

### Winco® PRIME

#### A Cut Above

Winco Prime® products are constructed with industry approved materials that comply with and exceed accepted industry standards.

All products in the Winco Prime® family are NSF listed, an assurance that every effort has been made to provide a safe and durable product at an affordable price.

Depend on Winco Prime® products, made to endure in the most demanding food service environment!



LADLES

BASTING SPOONS



PORTIONERS



BAIN MARIES, INSETS & LIDS

P.152,  
212,  
214  
&216

### DOUGH BOX & COVER

#### PL-SERIES

- ◆ Boxes stack tight to maintain product freshness
- ◆ Great for storing and proofing dough
- ◆ Reinforced structure resists breaks or bending over time
- ◆ Made of durable polypropylene
- ◆ Available in 2 depths

PL-3N  
PL-2N

IMPROVED  
STRUCTURE

PL-36NC



P.159,  
172 &186

BPA  
FREE

### WIRE DOLLY

#### DWR-2617

- ◆ Transport multiple dough boxes with ease
- ◆ Convenient transporting
- ◆ Capacity up to 400 Lbs
- ◆ Winco® exclusive
- ◆ 27"L x 18-1/4"W x 2-1/2"H



Transport dough boxes



P.159,  
186  
&268

### CHROME-PLATED WIRE SHEET PAN GRATE

#### PGW-1420

- ◆ Feet elevate food to keep from sticking to steam pan
- ◆ Can also be used as a cooling or icing rack

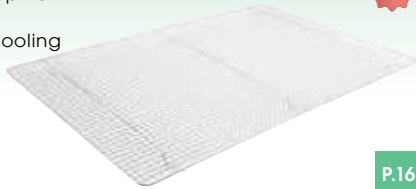

P.161

NEW  
SIZE

### ALUMINUM CAKE PANS

#### HAC-SERIES

NEW  
SIZES



HAC-042

HAC-062

P.165

### ALUMINUM LAYER CAKE PANS

#### ACP-SERIES

NEW  
SIZE



ACP-062

P.165

### ALUMINUM PIE PLATES

#### APPL-SERIES

NEW  
SIZES



APPL-8

APPL-11

P.165

## ROLL TOP COVER

### C-RCF

Keep food warm and accessible with the roll-top cover by Winco®. Fits any flat full-size steam table pan.

- ◆ 18/8 satin finish stainless steel
- ◆ Fits full-size food pan
- ◆ Easy access hinged cover
- ◆ Handle is heat resistant up to 220°F (105°C)



Closed lid on a food pan



Open lid on a food pan



Open

P.99  
&150

## PIZZA SERVING TONGS

### PZG-6

- ◆ Easily grab-n-serve a single pizza slice, a piece of pie and more!
- ◆ Wedge-shaped pie server with grabbing arm holds contents more securely

**GRAB n' SERVE**

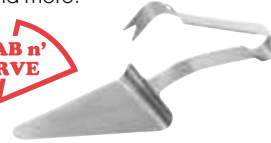

P.185

## PIZZA HEAT SINK

**NON-STICK**

### APHS-7

Say goodbye to burnt crusts and undercooked pizza centers! Place this non-stick pizza heat sink in the center of your deep-dish pizza pies to evenly distribute heat and shorten baking time.

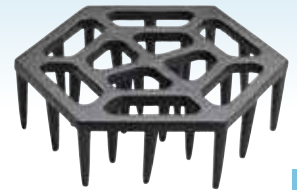

- ◆ 6-3/4"Dia, 22 pin

P.188

## STEAM TABLE PAN

### SPJH-906GN

- ◆ Ninth-Size GN pan
- ◆ 6" Deep
- ◆ 22 Gauge

**ADD 30% MORE COUNTER CAPACITY!**

WINCO® EXCLUSIVE SIZE



NSF  
NEW SIZE

P.148

## ALUMINUM PIZZA PEELS

### APP-SERIES

- ◆ Wooden handle
- ◆ Two new blade sizes available



APP-18M

NEW SIZES

P.184

## STAINLESS STEEL STEAM PAN/SHEET PAN GRATES

### PGWS-SERIES

- ◆ Feet elevate food to keep from sticking to steam pan
- ◆ Can also be used as a cooling or icing rack
- ◆ Available in 5 sizes

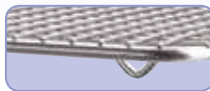

Raised Feet

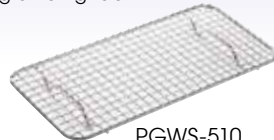

PGWS-510

P.151

## PIZZA BUBBLE POPPERS

### PZP-SERIES

- ◆ Long reach
- ◆ Available in aluminum & wooden handles

PZP-32



PZP-38WH

P.184

## FALSE BOTTOMS

### SPFB-SERIES

- ◆ 18/8 stainless steel
- ◆ Rust resistant
- ◆ Available in 6 sizes

**IMPROVED**

NEW SIZES



SPFB-9



SPFB-4



SPFB-3

P.151

## WIDE-RIM PIZZA PANS

### APZT-7, APZT-9

NEW SIZES



P.181

## ALUMINUM PIZZA SCREENS

### APZS-7

NEW SIZE



P.183



## TORTILLA PRESSES

### TPC-SERIES

- ◆ Traditional press with excellent leverage
- ◆ Integrated handle allows for easy open and removal of corn/flour tortillas
- ◆ Great for making burritos, enchiladas and quesadillas
- ◆ Available in cast iron and non-stick aluminum
- ◆ Each measures 8"Dia



**NON-STICK**



TPC-8C

TPC-8A

P.55 &195

## DIGITAL PORTION CONTROL SCALE

### SCAL-D20

- ◆ Ideal for quick-serve restaurant environment
- ◆ Removable stainless steel platform can be used as a tray
- ◆ Holds up to 20Lbs



P.194

## BUTTER ROLLER

### SPBR-604

- ◆ Standard 1/6 size steam table pan, fits into a 7" x 6-3/8" size opening
- ◆ Reduces butter and dressing waste
- ◆ Removable roller for easy cleaning
- ◆ Spreads butter quickly and evenly
- ◆ Sturdy stainless steel construction
- ◆ Designed for countertop access
- ◆ Ensures safe and sanitary food preparation



P.233

## BULK PASTA/IMMERSION BASKET

### MPN-1613

- ◆ Plastic coated handles rated for temperatures up to 250°F (120°C)
- ◆ Suitable for cooking all types of pasta in bulk
- ◆ Fits standard cookers



P.146 &228

## MINI LADELS

### MSL-SERIES

- ◆ Ideal for either measuring or serving small quantities
- ◆ Capacity stamped on each handle
- ◆ 5-Pc Set: 1/8 Tsp, 1/4 Tsp, 1/2 Tsp, 1 Tsp, 1 Tbsp
- ◆ MSL-11: 3/4 Tbsp

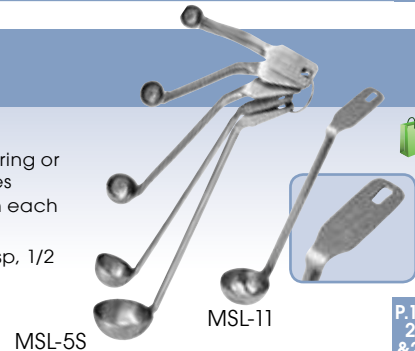

MSL-5S

MSL-11

P.180, 213 &224

## WOODEN CHINOIS PEDESTAL

### WPST-13

- ◆ Solid wood construction
- ◆ Press, crush and push mixtures through a bouillon strainer
- ◆ Fits standard size strainers



P.229

## STAINLESS STEEL SPAGHETTI STRAINER

### SSS-3

- ◆ 18/8 stainless steel
- ◆ Tri-riveted handle with helper hook that rests over rim of pot
- ◆ 8-1/2"Dia



P.230

## HOLLOW HANDLE BOUILLON STRAINERS

### CCB-SERIES

**NEW SIZES**



CCB-10

P.229

## CHINESE-STYLE COLANDER

### ALO-16H

**NEW SIZE**



P.199

## NYLON SPOONS

**BPA FREE**

### NS-SERIES

- ◆ Heat resistant up to 475°F (246°C)
- ◆ Available in 12" & 15"



**NEW COLORS**



NS-15R

NS-15B

P.222



### WASTE RECEPTACLE

**WR-35**

- ◆ Features tray-top design with 9"H self-return door
- ◆ Fits up to 35 gallon capacity trash can



P.252

### 3-TIER WIRE SHELVING CARTS

**VCCD-SERIES**

Winco's sturdy shelving now comes in a full cart set! Unlike traditional carts that have fixed heights, these wire shelving carts are height-adjustable to fit your storage needs.

- ◆ Includes three (3) adjustable height shelves
- ◆ Capacity up to 800 Lbs
- ◆ Step-lock feature on two casters
- ◆ Available in 2 sizes



VCCD-1836B

P.263

### WIRE TRASH CAN CART

**DWR-1708**

Move slender trash cans from one location to another with the ease of a rolling cart built for the task.

- ◆ Capacity up to 400 Lbs
- ◆ Wheels measure 3-3/4" diameter each
- ◆ Compatible with PTC-Series 23 gallon slender trash cans

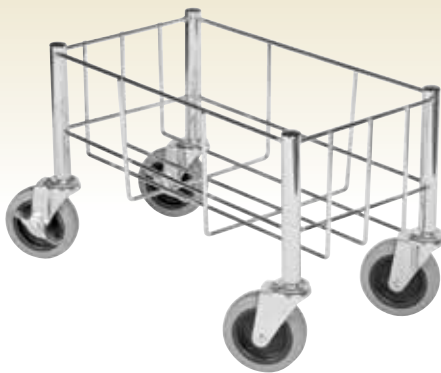

Fits standard slim trash cans

P.253

### WIRE SHELF POSTS

**VC-SERIES, VEX-SERIES**

- ◆ New sizes available in Chrome-Plated & Epoxy-Coated
- ◆ Use with wire shelving
- ◆ Available in 48"H & 54"H



P.264 & 265

### ALUMINUM DUNNAGE RACK

**ASDR-1424**

- ◆ Great for storing items off the floor in any environment
- ◆ Holds up to 1200 Lbs
- ◆ 14" x 24" x 8"

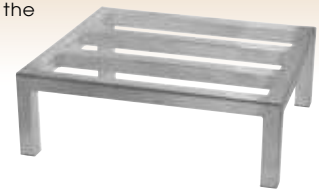

P.266

### WIRE DOLLY

**DWR-2617**

- ◆ Transport multiple dough boxes with ease
- ◆ Convenient transporting
- ◆ Capacity up to 400 Lbs
- ◆ Winco® exclusive
- ◆ 27"L x 18-1/4"W x 2-1/2"H



P.159, 186 & 268

### RETRACTABLE BOX CUTTER

**BXC-4**

- ◆ Handy for opening boxes or slicing cardboard
- ◆ Blade retracts into metal safety sleeve



P.250

## COUNTERTOP ELECTRIC COTTON CANDY MACHINE



### CCM-SERIES

- ◆ Simple, easy-to-use controls
- ◆ 20-1/2" diameter bowl is stainless steel
- ◆ Spinner head accommodates 4 oz. of floss sugar
- ◆ Easy access to voltage meter and fuse for use on generators and power supplies
- ◆ Optional clear lid (sold separately) provides protection from wind and debris



CCM-28

P.279

## COUNTERTOP ELECTRIC POPCORN MACHINE



### POP-SERIES

- ◆ 8 oz stainless steel kettle is removable; POP-8R includes non-stick kettle
- ◆ Clear plexiglass doors and stainless steel fold-out tray for easy access
- ◆ Built-in warmer light
- ◆ Removable crumb tray
- ◆ Tempered glass side panels



POP-8B



POP-8R

P.279

## COUNTERTOP HEATED DISPLAY MERCHANDISERS

### HDM-SERIES

- ◆ Removable water pan to add and control humidity
- ◆ Three (3) adjustable shelves inside, top can also be used as a shelf
- ◆ Lighted front display for branding visuals
- ◆ Visible thermometer gauge to ensure food keeps at proper temperatures
- ◆ Adjustable thermostat from 85°F to 195°F (30°C to 90°C)
- ◆ Customer-facing front service and rear access doors



HDM-13



HDM-26

P.276

## COUNTERTOP ELECTRIC HEATED PIZZA/PREZEL MERCHANDISERS

### EDM-SERIES

Digital control of both temperature and humidity.

- ◆ EDM-1 has forced air for convection heating
- ◆ EDM-1 uses active humidity with water fill-tray
- ◆ Display tray insert rotates when door is closed
- ◆ Accommodates four (4) full-size 18" pizzas
- ◆ Dimensions: 25-1/2"L x 23-3/4"W x 27-3/4"H



EDM-1



EDM-2



EDM-2PR

Optional Pretzel Rack

P.277

## COUNTERTOP ELECTRIC BLENDER

### XLB-1000

- ◆ High-performance motor with impact-resistant stainless steel blades
- ◆ Removable container cover and cap, pressure reduction when blending hot foods
- ◆ Includes an 11-1/2" tamper for blending solid foods
- ◆ 120V, 1450W



P.106 & 288

## COUNTERTOP COFFEE WARMER

### ECW-2S

Keep coffee fresh, hot and ready to serve at the optimal serving temperature. Coffee warmers are ideal for any self-service area.

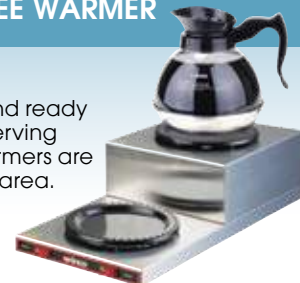

P.94 & 278

### ELECTRIC COUNTERTOP PIZZA OVEN

#### EPO-1

- ◆ Dual independently controlled heating elements
- ◆ 60 minute timer with bell includes "Stay On" feature
- ◆ Pizza tray handle folds for storage
- ◆ Includes crumb tray
- ◆ Designed to easily fit up to a 12" diameter pizza
- ◆ Dimensions: 20-7/8"L x 14-3/4"W x 9-1/4"H



P.285

### ELECTRIC COUNTERTOP CONVECTION OVENS

#### ECO-SERIES

- ◆ Stainless steel construction
- ◆ Built-in 120 minute timer with "Stay On" feature
- ◆ Dual pane tempered glass door
- ◆ Spacious interior includes three chrome wire shelves
- ◆ Whisper quiet circulation
- ◆ **ECO-250:** Use with 1/4"-size sheet pans (120V, 1440W, 12A)  
Overall Dimensions: 18-3/4" L x 19-7/8"W x 15"H
- ◆ **ECO-500:** Use with 1/2"-size sheet pans (120V, 1600W, 13.3A)  
Overall Dimensions: 22-1/2"L x 22-3/4"W x 17-3/4"H



Spacious interior



ECO-500

P.285

### ELECTRIC STRIP HEATER

#### ESH-1

- ◆ Includes undermount bracket and bolt set (ESH-UB) for optional mounting under shelves
- ◆ Stand adjusts to three height positions: 17-1/2"H, 20"H, and 22-1/2"H
- ◆ Extruded aluminum body for durability and cleanliness
- ◆ Tubular sheath heating element provides constant and reliable infrared heating
- ◆ Dimensions w/base: 25-1/2"L x 14"W x various heights
- ◆ Without base: 24"L x 6"W x 2-1/2"H
- ◆ 100-120V, 500W, 4.2A



P.283

### COUNTERTOP REFRIGERATED BEVERAGE DISPLAYS

#### CRD-SERIES

- ◆ Digital temperature control from 32°F to 54°F
- ◆ Durable triple-layered PVC-coated shelves
- ◆ 2 double-glass doors for versatile placement and easy access
- ◆ 360° view of refrigerated product
- ◆ 4 LED strips for effective product lighting
- ◆ Comfortably fits up to 100 cans (standard 12 oz) with 25 cans per shelf
- ◆ Adjustable shelf height to fit multiple product sizes
- ◆ Automatic defrost and ventilated cooling system
- ◆ Dimensions: 17"L x 17"W x 39"H
- ◆ 120V, 164W



CRD-1  
Comfortably fits 100 cans



CRD-1K

P.278

### PANASONIC 23-CUP COMMERCIAL ELECTRIC RICE COOKER

#### SR-GA421H

- ◆ Stainless steel lid with glass window
- ◆ Aluminum alloy inner pot is removable
- ◆ Built-in thermal safety fuse
- ◆ Automatic shut-off
- ◆ Keeps contents warm up to 5 hours



P.286



# ARDESIA™

by **winco**®

Whether a classic white look, an infusion of color, or adding a rustic flare is the style you're after, the Ardesia™ by Winco® collections offer a variety of ceramic, melamine and slate tableware options that are sure to fulfill your needs.

Exclusively distributed by Winco® | [www.wincous.com](http://www.wincous.com)  
Please see our Dinnerware Catalog for more information.

Add a flair of metropolitan luxury to the table with a collection of refreshingly modern, chic and elegant flatware and holloware.

Cadenza™





# FRONT OF HOUSE

*Dining & Service*



# SHANGARILA



*With simple and elegant contoured lines, the Shangarila pattern brings an understated sophistication to any setting.*

- ◆ 18/8 stainless steel
- ◆ Extra heavyweight
- ◆ Mirror finish
- ◆ 3.0mm thickness  
dinner fork and spoon

ITEM	DESCRIPTION	LENGTH	UOM	CASE
0030-01	Teaspoon	6"	Doz	25
0030-02	Iced Tea Spoon	7-3/8"	Doz	25
0030-03	Dinner Spoon	7-1/4"	Doz	25
0030-04	Bouillon Spoon	5-7/8"	Doz	25
0030-05	Dinner Fork	7-1/4"	Doz	25
0030-06	Salad Fork	6-3/4"	Doz	25
0030-07	Oyster Fork	5-11/16"	Doz	25
0030-08	Dinner Knife	9-1/4"	Doz	15
0030-09	Demitasse Spoon	4-5/8"	Doz	25
0030-10	Tablespoon (Euro Length)	8-1/4"	Doz	25
0030-11	Table Fork (Euro Length)	8"	Doz	25
0030-12	Butter Spreader	6-3/4"	Doz	25
0030-15	Hollow Handle Table Knife	9-1/4"	Doz	15
0030-16	Steak Knife Pointed Tip	8-7/8"	Doz	15
0030-18	European Table Knife	9-3/4"	Doz	15
0030-19	Salad Knife	8-7/16"	Doz	15



SEE PAGE 32 FOR  
COORDINATING  
SHANGARILA  
SERVING PIECES

# PEACOCK



*Like its namesake, the sculpted detail of the Peacock pattern blends seamlessly into any elaborate setting.*

- ◆ 18/8 stainless steel
- ◆ Extra heavyweight
- ◆ Mirror finish
- ◆ 3.0mm thickness  
dinner fork and spoon

ITEM	DESCRIPTION	LENGTH	UOM	CASE
0031-01	Teaspoon	6-1/8"	Doz	25
0031-02	Iced Tea Spoon	7-13/16"	Doz	25
0031-03	Dinner Spoon	7-9/16"	Doz	25
0031-04	Bouillon Spoon	6"	Doz	25
0031-05	Dinner Fork	7-13/16"	Doz	25
0031-06	Salad Fork	6-3/4"	Doz	25
0031-07	Oyster Fork	5-3/4"	Doz	25
0031-08	Dinner Knife	8-7/8"	Doz	15
0031-09	Demitasse Spoon	4-1/2"	Doz	25
0031-10	Tablespoon (Euro Length)	8-3/8"	Doz	25
0031-11	Table Fork (Euro Length)	8"	Doz	25
0031-12	Butter Spreader	6-3/4"	Doz	25
0031-18	European Table Knife	9-5/8"	Doz	15

# CHANTELLE



*Inspired by the Regency era, the delicate flourished lines of the Chantelle pattern add a traditional touch to any setting.*

- ◆ 18/8 stainless steel
- ◆ Extra heavyweight
- ◆ Mirror finish
- ◆ 3.0mm thickness  
dinner fork and spoon

ITEM	DESCRIPTION	LENGTH	UOM	CASE
0039-01	Teaspoon	6"	Doz	25
0039-02	Iced Tea Spoon	7-1/2"	Doz	25
0039-03	Dinner Spoon	7-1/4"	Doz	25
0039-04	Bouillon Spoon	5-7/8"	Doz	25
0039-05	Dinner Fork	7-1/4"	Doz	25
0039-06	Salad Fork	6-1/4"	Doz	25
0039-07	Oyster Fork	5-5/8"	Doz	25
0039-08	Dinner Knife	9-5/16"	Doz	15
0039-09	Demitasse Spoon	4-5/8"	Doz	25
0039-10	Tablespoon (Euro Length)	8-1/2"	Doz	25
0039-11	Table Fork (Euro Length)	8-1/8"	Doz	25
0039-12	Butter Spreader	6-3/4"	Doz	25

# VENICE



*Inspired by the water of the floating city, the smooth surface of the Venice pattern brings an understated elegance to any contemporary setting.*

- ◆ 18/8 stainless steel
- ◆ Extra heavyweight
- ◆ Mirror finish
- ◆ 3.0mm thickness dinner fork and spoon

ITEM	DESCRIPTION	LENGTH	UOM	CASE
0037-01	Teaspoon	6-1/8"	Doz	25
0037-02	Iced Tea Spoon	7-1/4"	Doz	25
0037-03	Dinner Spoon	7-3/8"	Doz	25
0037-04	Bouillon Spoon	6-1/4"	Doz	25
0037-05	Dinner Fork	7-3/8"	Doz	25
0037-06	Salad Fork	6-3/4"	Doz	25
0037-07	Oyster Fork	5-5/8"	Doz	25
0037-08	Dinner Knife	9-1/8"	Doz	15
0037-09	Demitasse Spoon	4-1/2"	Doz	25
0037-10	Tablespoon (Euro Length)	8-1/4"	Doz	25
0037-11	Table Fork (Euro Length)	8-3/8"	Doz	25
0037-12	Butter Spreader	6-3/4"	Doz	25

# DELUXE PEARL



*Like a strand of pearls, the delicate beading detail of the Deluxe Pearl pattern is a timeless classic that will enhance any setting.*

- ◆ 18/8 stainless steel
- ◆ Extra heavyweight
- ◆ Mirror finish
- ◆ 3.0mm thickness  
dinner fork and spoon

ITEM	DESCRIPTION	LENGTH	UOM	CASE
0036-01	Teaspoon	6"	Doz	25
0036-02	Iced Tea Spoon	7-1/8"	Doz	25
0036-03	Dinner Spoon	7-1/4"	Doz	25
0036-04	Bouillon Spoon	5-7/8"	Doz	25
0036-05	Dinner Fork	7-1/4"	Doz	25
0036-06	Salad Fork	7"	Doz	25
0036-07	Oyster Fork	5-3/8"	Doz	25
0036-08	Dinner Knife	9"	Doz	15
0036-09	Demitasse Spoon	4-1/4"	Doz	25
0036-10	Tablespoon (Euro Length)	8-1/8"	Doz	25
0036-11	Table Fork (Euro Length)	8-1/8"	Doz	25
0036-12	Butter Spreader	6-3/4"	Doz	25
0036-16	Salad Knife	8-3/8"	Doz	25

# STANFORD



*With a subtle elevated fold down the center of a teardrop-shaped handle, the Stanford pattern brings an elegant touch to a contemporary setting.*

- ◆ 18/8 stainless steel
- ◆ Extra heavyweight
- ◆ Mirror finish
- ◆ 3.0mm thickness dinner fork and spoon

ITEM	DESCRIPTION	LENGTH	UOM	CASE
0034-01	Teaspoon	6"	Doz	25
0034-02	Iced Tea Spoon	7-5/16"	Doz	25
0034-03	Dinner Spoon	7-1/8"	Doz	25
0034-04	Bouillon Spoon	6-15/16"	Doz	25
0034-05	Dinner Fork	7-1/8"	Doz	25
0034-051	Dinner Fork, Extended Length	7-1/4"	Doz	25
0034-06	Salad Fork	5-7/8"	Doz	25
0034-061	Salad Fork, Extended Length	6-7/8"	Doz	25
0034-07	Oyster Fork	5-7/16"	Doz	25
0034-08	Dinner Knife	9"	Doz	15
0034-09	Demitasse Spoon	4-3/8"	Doz	25
0034-10	Tablespoon (Euro Length)	8-5/8"	Doz	25
0034-11	Table Fork (Euro Length)	8-1/4"	Doz	25
0034-12	Butter Spreader	6-5/8"	Doz	25
0034-15	Hollow Handle Dinner Knife	8-3/4"	Doz	15
0034-18	Hollow Handle Table Knife	9-5/8"	Doz	15

# VICTORIA



*The simple aristocratic lines of the Victoria pattern make it an ideal choice for a formal setting.*

- ◆ 18/8 stainless steel
- ◆ Extra heavyweight
- ◆ Mirror finish
- ◆ 3.0mm thickness  
dinner fork and spoon

ITEM	DESCRIPTION	LENGTH	UOM	CASE
0035-01	Teaspoon	6"	Doz	25
0035-02	Iced Tea Spoon	7-1/2"	Doz	25
0035-03	Dinner Spoon	7-3/8"	Doz	25
0035-04	Bouillon Spoon	5-7/8"	Doz	25
0035-05	Dinner Fork	7-1/4"	Doz	25
0035-06	Salad Fork	6-7/8"	Doz	25
0035-07	Oyster Fork	5-9/16"	Doz	25
0035-08	Dinner Knife	9-1/4"	Doz	15
0035-09	Demitasse Spoon	4-3/8"	Doz	25
0035-10	Tablespoon (Euro Length)	8-1/4"	Doz	25
0035-11	Table Fork (Euro Length)	8-1/4"	Doz	25
0035-12	Butter Spreader	6-3/4"	Doz	25
0035-16	Salad Knife	8-1/2"	Doz	25



# OXFORD



*The dignified outline on the fiddle-shaped handle of the Oxford pattern lends a touch of old-fashioned elegance to a setting.*

- ◆ 18/8 stainless steel
- ◆ Extra heavyweight
- ◆ Mirror finish
- ◆ 3.0mm thickness dinner fork and spoon

ITEM	DESCRIPTION	LENGTH	UOM	CASE
0033-01	Teaspoon	6-1/4"	Doz	25
0033-02	Iced Tea Spoon	7-1/2"	Doz	25
0033-03	Dinner Spoon	7-3/8"	Doz	25
0033-04	Bouillon Spoon	6"	Doz	25
0033-05	Dinner Fork	7-5/8"	Doz	25
0033-06	Salad Fork	7"	Doz	25
0033-07	Oyster Fork	5-5/8"	Doz	25
0033-08	Dinner Knife	9-5/8"	Doz	15
0033-09	Demitasse Spoon	4-1/2"	Doz	25
0033-10	Tablespoon (Euro Length)	8"	Doz	25
0033-11	Table Fork (Euro Length)	8-1/8"	Doz	25
0033-12	Butter Spreader	7"	Doz	25

## CONTINENTAL



The Continental pattern is the moderately priced version of the Shangarila pattern with the same simple contour lines and features.

- ◆ 18/0 stainless steel
- ◆ Extra heavyweight
- ◆ Mirror finish
- ◆ 3.0mm thickness dinner fork and spoon

ITEM	DESCRIPTION	LENGTH	UOM	CASE
0021-01	Teaspoon	6"	Doz	25
0021-02	Iced Teaspoon	7-1/2"	Doz	25
0021-03	Dinner Spoon	7-1/4"	Doz	25
0021-04	Bouillon Spoon	5-7/8"	Doz	25
0021-05	Dinner Fork	7-1/4"	Doz	25
0021-06	Salad Fork	6-3/4"	Doz	25
0021-07	Oyster Fork	5-5/8"	Doz	25
0030-08	Dinner Knife	9-1/4"	Doz	15
0021-09	Demitasse Spoon	4-1/8"	Doz	25
0021-10	Tablespoon (Euro Length)	8-1/4"	Doz	25
0021-11	Table Fork (Euro Length)	8"	Doz	25

## TOULOUSE



The Toulouse pattern features a fiddle shape handle with a stylish shell motif.

- ◆ 18/0 stainless steel
- ◆ Extra heavyweight
- ◆ Mirror finish
- ◆ 3.0mm thickness dinner fork and spoon

ITEM	DESCRIPTION	LENGTH	UOM	CASE
0006-01	Teaspoon	6-3/8"	Doz	25
0006-02	Iced Tea Spoon	7"	Doz	25
0006-03	Dinner Spoon	7-3/8"	Doz	25
0006-04	Bouillon Spoon	6-3/8"	Doz	25
0006-05	Dinner Fork	7-5/8"	Doz	25
0006-06	Salad Fork	7"	Doz	25
0006-07	Oyster Fork	6"	Doz	25
0006-08	Dinner Knife	8-3/4"	Doz	25
0006-09	Demitasse Spoon	4-5/8"	Doz	25
0006-10	Tablespoon	8-1/4"	Doz	25
0006-12	Butter Spreader	7-1/16"	Doz	25

The Dots pattern features simple lines and elegant beading details around the handle and neck.

- ◆ 18/0 stainless steel
- ◆ Heavyweight
- ◆ Mirror finish

ITEM	DESCRIPTION	LENGTH	UOM	CASE
0005-01	Teaspoon	6-1/4"	Doz	50
0005-02	Iced Tea Spoon	7-1/8"	Doz	50
0005-03	Dinner Spoon	7-3/8"	Doz	50
0005-04	Bouillon Spoon	6-1/8"	Doz	50
0005-05	Dinner Fork	7-3/8"	Doz	50
0005-06	Salad Fork	6-1/4"	Doz	50
0005-07	Oyster Fork	5-5/8"	Doz	50
0005-08	Dinner Knife	8-3/4"	Doz	25
0005-09	Demitasse Spoon	4-3/4"	Doz	50
0005-10	Tablespoon	8-3/8"	Doz	25



The Lafayette pattern features a ridged surface with a double scallop accent.

- ◆ 18/0 stainless steel
- ◆ Heavyweight
- ◆ Satin finish

ITEM	DESCRIPTION	LENGTH	UOM	CASE
0015-01	Teaspoon	6"	Doz	50
0015-02	Iced Tea Spoon	7-1/4"	Doz	50
0015-03	Dinner Spoon	7-1/4"	Doz	50
0015-04	Bouillon Spoon	6"	Doz	50
0015-05	Dinner Fork	7-5/8"	Doz	50
0015-054	Dinner Fork, 4 tines	7-1/2"	Doz	50
0015-06	Salad Fork	6-3/4"	Doz	50
0015-07	Oyster Fork	5-1/2"	Doz	50
0015-08	Dinner Knife	7-3/8"	Doz	25
0015-10	Dinner Knife, Hollow Handle	9-1/4"	Doz	15
0015-11	Steak Knife, Hollow Handle	9-1/4"	Doz	15





The Regency pattern features defined, clean column lines.

- ◆ 18/0 stainless steel
- ◆ Heavyweight
- ◆ Mirror finish

ITEM	DESCRIPTION	LENGTH	UOM	CASE
0007-01	Teaspoon	6"	Doz	50
0007-03	Dinner Spoon	7-1/8"	Doz	50
0007-04	Bouillon Spoon	5-5/8"	Doz	50
0007-05	Dinner Fork	7-3/8"	Doz	50
0007-06	Salad Fork	6-1/16"	Doz	50
0007-08	Dinner Knife	8-1/2"	Doz	25



The Lisa pattern features clean lines and a distinctively raised pitch.

- ◆ 18/0 stainless steel
- ◆ Heavyweight
- ◆ Mirror finish

ITEM	DESCRIPTION	LENGTH	UOM	CASE
0010-01	Teaspoon	6-1/16"	Doz	50
0010-03	Dinner Spoon	7-3/4"	Doz	50
0010-05	Dinner Fork	7-5/8"	Doz	50
0010-08	Dinner Knife	8-1/8"	Doz	25

The Winston pattern features a fiddle shaped handle with a smooth finish.

- ◆ 18/0 stainless steel
- ◆ Heavyweight
- ◆ Satin finish

ITEM	DESCRIPTION	LENGTH	UOM	CASE
0016-01	Teaspoon	6-1/8"	Doz	50
0016-02	Iced Tea Spoon	7-3/4"	Doz	50
0016-03	Dinner Spoon	7-3/8"	Doz	50
0016-04	Bouillon Spoon	6-1/8"	Doz	50
0016-05	Dinner Fork	7-1/4"	Doz	50
0016-06	Salad Fork	6-1/2"	Doz	50
0016-08	Dinner Knife	8-3/8"	Doz	25



The Manhattan pattern features subtle grooves from the handle neck to the mid-section.

- ◆ 18/0 stainless steel
- ◆ Heavyweight
- ◆ Satin finish

ITEM	DESCRIPTION	LENGTH	UOM	CASE
0008-01	Teaspoon	6-1/8"	Doz	50
0008-03	Dinner Spoon	6-3/4"	Doz	50
0008-04	Bouillon Spoon	6"	Doz	50
0008-05	Dinner Fork	7-1/4"	Doz	50
0008-08	Dinner Knife	8-1/8"	Doz	25





The Elite pattern features a smooth contoured handle with rounded tip.

- ◆ 18/0 stainless steel
- ◆ Heavyweight
- ◆ Mirror finish

ITEM	DESCRIPTION	LENGTH	UOM	CASE
0026-01	Teaspoon	6"	Doz	50
0026-03	Dinner Spoon	7"	Doz	50
0026-04	Bouillon Spoon	5-7/8"	Doz	50
0026-05	Dinner Fork	7-1/8"	Doz	50
0026-06	Salad Fork	6-1/8"	Doz	50
0026-08	Dinner Knife	8-5/8"	Doz	25



The Flute pattern features an elongated oval handle with a smooth finish.

- ◆ 18/0 stainless steel
- ◆ Heavyweight
- ◆ Mirror finish

ITEM	DESCRIPTION	LENGTH	UOM	CASE
0019-01	Teaspoon	5-7/8"	Doz	50
0019-03	Dinner Spoon	7-3/16"	Doz	50
0019-04	Bouillon Spoon	5-5/8"	Doz	50
0019-05	Dinner Fork	7-3/8"	Doz	50
0019-06	Salad Fork	6-1/4"	Doz	50
0019-08	Dinner Knife	9"	Doz	25

The Houston pattern features a fiddle shape handle with a turned out collar at the neck.

- ◆ 18/0 stainless steel
- ◆ Heavyweight
- ◆ Satin finish

ITEM	DESCRIPTION	LENGTH	UOM	CASE
0025-01	Teaspoon	6-1/8"	Doz	50
0025-03	Dinner Spoon	7-3/16"	Doz	50
0025-04	Bouillon Spoon	6"	Doz	50
0025-05	Dinner Fork	7-3/8"	Doz	50
0025-06	Salad Fork	6-1/8"	Doz	50
0025-08	Dinner Knife	8-3/4"	Doz	25



## GRAPEFRUIT SPOON

Complete any table setting with this grapefruit spoon. The serrated edge cuts easily into any citrus fruit.

ITEM	DESCRIPTION	LENGTH	UOM	CASE
SRS-6	Grapefruit Spoon, Heavyweight	6-1/4"	Doz	25





The Elegance pattern in mirror finish features embossed floral embellishments with a single motif at the handle tip.

- ◆ 18/0 stainless steel
- ◆ Heavyweight
- ◆ Mirror finish

ITEM	DESCRIPTION	LENGTH	UOM	CASE
0024-01	Teaspoon	6-1/4"	Doz	50
0024-03	Dinner Spoon	7-1/8"	Doz	50
0024-04	Bouillon Spoon	6-3/16"	Doz	50
0024-05	Dinner Fork	7-3/8"	Doz	50

SEE PAGE 44 FOR COORDINATING ELEGANCE SERVING PIECES

The Elegance pattern in vibro finish features embossed floral embellishments with a single motif at the handle tip.

- ◆ 18/0 stainless steel
- ◆ Heavyweight
- ◆ Vibro finish

ITEM	DESCRIPTION	LENGTH	UOM	CASE
0004-01	Teaspoon	6-3/8"	Doz	50
0004-02	Iced Teaspoon	8"	Doz	50
0004-03	Dinner Spoon	7-1/4"	Doz	50
0004-04	Bouillon Spoon	6"	Doz	50
0004-05	Dinner Fork	7-1/4"	Doz	50
0004-06	Salad Fork	6-1/2"	Doz	50
0004-07	Oyster Fork	6"	Doz	50
0004-08	Dinner Knife	8-5/8"	Doz	25
0004-09	Demitasse Spoon	4-1/2"	Doz	50
0004-10	Tablespoon	8-3/8"	Doz	25

FLATWARE IN CLEAR VIEW PACK



0081-01



0081-05



0081-08

- ◆ 18/0 stainless steel
- ◆ Medium weight
- ◆ Vibro finish



DOMINION IN CLEAR VIEW PACK

ITEM	DESCRIPTION	LENGTH	UOM	CASE
0081-01	Teaspoon, 2-Doz/Pk	5-13/16"	Pack	24
0081-02	Iced Teaspoon, 2-Doz/Pk	7-7/8"	Pack	24
0081-03	Dinner Spoon, 2-Doz/Pk	7"	Pack	24
0081-04	Bouillon Spoon, 2-Doz/Pk	6"	Pack	24
0081-05	Dinner Fork, 2-Doz/Pk	7-1/8"	Pack	24
0081-06	Salad Fork, 2-Doz/Pk	6-1/8"	Pack	24
0081-07	Oyster Fork, 2-Doz/Pk	5-5/8"	Pack	24
0081-08	Dinner Knife, 1-Doz/Pk	8"	Pack	24



WINDSOR IN CLEAR VIEW PACK

ITEM	DESCRIPTION	LENGTH	UOM	CASE
0082-01	Teaspoon, 2-Doz/Pk	5-7/8"	Pack	24
0082-02	Iced Teaspoon, 2-Doz/Pk	8"	Pack	24
0082-03	Dinner Spoon, 2-Doz/Pk	7"	Pack	24
0082-04	Bouillon Spoon, 2-Doz/Pk	6"	Pack	24
0082-05	Dinner Fork, 2-Doz/Pk	7"	Pack	24
0082-06	Salad Fork, 2-Doz/Pk	6-1/4"	Pack	24
0082-07	Oyster Fork, 2-Doz/Pk	5-1/2"	Pack	24
0082-08	Dinner Knife, 1-Doz/Pk	8"	Pack	24



0082-01



0082-05



0082-08



The Dominion pattern features an art deco design with two lines down the length of the handle.

## DOMINION

- ◆ 18/0 stainless steel
- ◆ Medium weight
- ◆ Vibro finish

ITEM	DESCRIPTION	LENGTH	UOM	CASE
0001-01	Teaspoon	5-13/16"	Doz	50
0001-02	Iced Teaspoon	7-7/8"	Doz	50
0001-03	Dinner Spoon	7"	Doz	50
0001-04	Bouillon Spoon	6"	Doz	50
0001-05	Dinner Fork	7-1/8"	Doz	50
0001-06	Salad Fork	6-1/8"	Doz	50
0001-07	Oyster Fork	5-5/8"	Doz	50
0001-08	Dinner Knife	8"	Doz	25
0001-09	Demitasse Spoon	4-5/8"	Doz	50
0001-10	Tablespoon	7-5/8"	Doz	25

- ◆ 18/0 stainless steel
- ◆ Heavyweight
- ◆ Vibro finish

ITEM	DESCRIPTION	LENGTH	UOM	CASE
0014-01	Teaspoon	5-3/4"	Doz	50
0014-03	Dinner Spoon	7"	Doz	50
0014-04	Bouillon Spoon	5-7/8"	Doz	50
0014-05	Dinner Fork	7-1/16"	Doz	50
0014-06	Salad Fork	6-1/8"	Doz	50
0014-08	Dinner Knife, 55g	7-7/8"	Doz	25



The Windsor pattern is a classic that features a smooth contour design.

## WINDSOR

- ◆ 18/0 stainless steel
- ◆ Medium weight
- ◆ Vibro finish

ITEM	DESCRIPTION	LENGTH	UOM	CASE
0002-01	Teaspoon	5-7/8"	Doz	50
0002-02	Iced Teaspoon	8"	Doz	50
0002-03	Dinner Spoon	7"	Doz	50
0002-04	Bouillon Spoon	6"	Doz	50
0002-05	Dinner Fork	7"	Doz	50
0002-06	Salad Fork	6-1/4"	Doz	50
0002-07	Oyster Fork	5-1/2"	Doz	50
0002-08	Dinner Knife	8"	Doz	25
0002-09	Demitasse Spoon	4-5/8"	Doz	50
0002-10	Tablespoon	7-5/8"	Doz	25

- ◆ 18/0 stainless steel
- ◆ Heavyweight
- ◆ Vibro finish

ITEM	DESCRIPTION	LENGTH	UOM	CASE
0012-01	Teaspoon	5-15/16"	Doz	50
0012-03	Dinner Spoon	7"	Doz	50
0012-04	Bouillon Spoon	5-7/8"	Doz	50
0012-05	Dinner Fork	7-1/16"	Doz	50
0012-06	Salad Fork	6-1/8"	Doz	50
0012-08	Dinner Knife, 55g	8"	Doz	25



SERVING PIECES

SHANGARILA SERVING PIECES

- ◆ 18/8 stainless steel
- ◆ Extra heavyweight
- ◆ Mirror finish

ITEM	DESCRIPTION	LENGTH	UOM	CASE
0030-21	Large Bowl Serving Spoon	9"	Doz	10
0030-22	Cold Meat Fork	8-1/2"	Doz	10
0030-23	Solid Spoon	11-1/2"	Doz	10
0030-24	Banquet Slotted Spoon	11-1/2"	Doz	10
0030-25	Banquet Fork	12"	Doz	10

SHANGARILA SERVING SET



SEE PAGE 16 FOR COORDINATING SHANGARILA FLATWARE

HOLLOW HANDLE KNIVES

ITEM	DESCRIPTION	LENGTH	UOM	CASE
0015-10	Lafayette Dinner Knife	9-1/4"	Doz	15
0015-11	Lafayette Steak Knife	9-1/4"	Doz	15
0030-15	Shangarila Table Knife	9-1/4"	Doz	15
0034-15*	Stanford Dinner Knife	8-3/4"	Doz	15
0034-18*	Stanford Table Knife	9-5/8"	Doz	15

\*0034-15 & 0034-18 knives are suitable for any of our 18/8 patterns.





## ACERO STEAK KNIVES

With its sharp serrated edge and pointed tip, the Acero knife is designed to make simple work of cutting through steaks and chops. A stainless steel end cap provides excellent balance and control. This heavy-weight knife is a Winco exclusive and is a must-have on the tables of any steak house.



ITEM	DESCRIPTION	BLADE	UOM	CASE
SK-1	Acero Gourmet Steak Knives, 4-pc Gift Pack	5"	Pack	6
SK-12	Acero Gourmet Steak Knives, 12-pc Bulk Pack	5"	Doz	6
SK-22	Acero Gourmet Steak Knives, Round Tip	5"	Doz	6

## STEAK KNIVES



SK-SERIES

## WOODEN HANDLE KNIVES

ITEM	DESCRIPTION	BLADE	UOM	CASE
KB-30W	Jumbo Steak Knives, Pointed Tip	5"	Doz	12
KB-15W	Jumbo Steak Knives, Round Tip	5"	Doz	12
K-438W	Steak Knives, Pointed Tip and Handle	4-3/8"	Doz	50
K-55W	Steak Knives, Rounded Tip	4-1/2"	Doz	48
K-45W	Steak Knives, Pointed Tip	4-1/2"	Doz	48
K-35W	Economy Steak Knives, Pointed Tip	4"	Doz	48



## PLASTIC HANDLE KNIVES

ITEM	DESCRIPTION	BLADE	UOM	CASE
K-80P	Jumbo Steak Knives, Round Tip, 3 Rivets	5"	Doz	25
K-85P	Jumbo Steak Knives, Round Tip, 2 Rivets, NSF	5"	Doz	12
K-60P	Steak Knives, Pointed Tip, NSF	5"	Doz	48
K-50P	Steak Knives, Round Tip, NSF	5"	Doz	48



# VIRTUOSO

EXTRA HEAVYWEIGHT SERIES

CONDENSATION CHANNEL KEEPS TABLE DRY



101A



101B



103A



103B

ITEM	DESCRIPTION	UOM	CASE
101A	8 Qt. Full-size, Gold Accent	Set	1
101B	8 Qt. Full-size	Set	1
103A	6 Qt. Round, Gold Accent	Set	1
103B	6 Qt. Round	Set	1
101-WP	Water Pan for 101A, 101B	Each	1
103-WP	Water Pan for 103A, 103B	Each	5
NSF SPF2	Food Pan for 101A, 101B, NSF	Each	6/12
602-FP	Food Pan for 103A, 103B	Each	12
SPFD-2R	Round Divided Food Pan for 103A, 103B	Each	10
C-F1	Fuel Holder with Cover	Each	12/48

Create the ultimate modern buffet presentation with the Virtuoso collection of premium chafers. Featuring beautiful, clean styling and optional gold-plated accents.

- ◆ 18/8 stainless steel mirror finish
- ◆ Roll-top cover opens to 90° or 180°
- ◆ Condensation from cover interior drips into water pan and keeps table surface dry
- ◆ Includes food pan, water pan and fuel holder(s)
- ◆ Stackable

SEE PAGE 40 FOR MATCHING VIRTUOSO COFFEE URNS



# VINTAGE

EXTRA HEAVYWEIGHT SERIES



108A



308A

Create the most elegant buffet setting with the Vintage collection of premium chafers. Featuring gleaming mirror finish dome covers and curved legs in gold accents.

- ◆ Stainless steel mirror finish
- ◆ Roll-top cover opens to 90° or 160°
- ◆ Includes food pan, water pan and fuel holder(s)

ITEM	DESCRIPTION	UOM	CASE
108A	8 Qt Full-Size	Set	1
308A	6 Qt Round	Set	1
108A-WP	Water Pan for 108A & 109	Each	10
NSF-SPF2	Food Pan for 108A, NSF	Each	6/12
SPFD-2R	Round Divided Food Pan for 308A	Each	10
C-F1	Fuel Holder with Cover	Each	12/48



**MADISON**  
HEAVYWEIGHT SERIES



601

- ◆ A modern design, perfect for casual and formal settings
- ◆ Stainless steel with highly polished mirror finish dome covers
- ◆ Roll-top covers can stay open at any angle
- ◆ Includes food pan, water pan and fuel holder(s)

ITEM	DESCRIPTION	UOM	CASE
601	8 Qt Full-Size	Set	1
602	6 Qt Round	Set	1
603	8 Qt Oval	Set	1
601-WP1	Water Pan for 601	Each	8
602-WP	Water Pan for 602	Each	12
603-WP	Water Pan for 603	Each	6
NSF SPF2	Food Pan for 601, NSF	Each	6/12
602-FP	Food Pan for 602	Each	12
SPFD-2R	Round Divided Food Pan for 602	Each	10
603-FP	Food Pan for 603	Each	10
C-F1	Fuel Holder with Cover	Each	12/48



602



603



SEE PAGE 39 FOR  
ELECTRIC WATER  
PAN TO FIT FULL-SIZE  
CHAFERS

**DALLAS**  
HEAVYWEIGHT SERIES



C-6080

- ◆ Solid design with gold accented handles
- ◆ Available with lift-off or roll-top cover options
- ◆ Polished stainless steel with mirror finish covers
- ◆ Includes food pan, water pan and fuel holder(s)

ITEM	DESCRIPTION	UOM	CASE
C-6080	8 Qt Full-Size, Lift-off	Set	1
C-5080	8 Qt Full-Size, Roll-top	Set	1
C-RTC	Roll-top Cover for C-6080, C-5080	Each	1
C-WPF	Water Pan for C-6080, C-5080	Each	6
NSF SPF2	Food Pan for C-6080, C-5080, NSF	Each	6/12
C-F1	Fuel Holder with Cover	Each	12/48



C-5080



- ◆ Elegance combined with ornate details, the Crown collection is designed exclusively for formal settings
- ◆ Stainless steel mirror finish
- ◆ Includes food pan, water pan and fuel holder(s)
- ◆ Wooden handles

**CROWN**  
**MEDIUM-WEIGHT SERIES**

ITEM	DESCRIPTION	UOM	CASE
▶ 408-1	8 Qt Full-Size	Set	1
▶ 508	4 Qt Half-Size, Square	Set	1
▶ 708	6 Qt, Round	Set	1
C-WPF	Water Pan for 408-1	Each	6
508-WP	Water Pan for 508	Each	6
708-WP	Water Pan for 708	Each	6
NSF SPF2	Food Pan for 408-1, NSF	Each	6/12
508-FP	Food Pan for 508	Each	1
708-FP	Food Pan for 708	Each	6
C-F1	Fuel Holder with Cover	Each	12/48



- ◆ Classic art deco design with gold accents
- ◆ Polished stainless steel with mirror finish covers
- ◆ 8 quart full-size chafin features a frame clip for the cover
- ◆ Includes food pan, water pan and fuel holder(s)

**MALIBU**  
**MEDIUM-WEIGHT SERIES**

ITEM	DESCRIPTION	UOM	CASE
▶ 201	8 Qt Full-Size	Set	1
▶ 202	6 Qt Oval	Set	1
▶ 203	4 Qt Round	Set	1
C-WPF	Water Pan for 201	Each	6
202-WP	Water Pan for 202	Each	12
203-WP	Water Pan for 203	Each	12
NSF SPF2	Food Pan for 201, NSF	Each	6/12
202-FP	Food Pan for 202	Each	12
203-FP	Food Pan for 203	Each	12
C-F1	Fuel Holder with Cover	Each	12/48



**NEWBURG**



C-3080B



Handy lid clips hold lid in place

- ◆ Simple and elegant design with a mirror finish cover
- ◆ Clips on frame conveniently hold cover when open
- ◆ High legs allow for extra space to prevent fuel holder bottoms from overheating table surface
- ◆ Includes water pan, food pan, two fuel holders and plastic handle

ITEM	DESCRIPTION	UOM	CASE
C-3080B	8 Qt Full-Size	Set	1
C-WPF	Water Pan for C-3080B	Each	6
SPF2	Food Pan for C-3080B, NSF	Each	6/12
C-F1	Fuel Holder with Cover	Each	12/48

**GET-A-GRIP**



C-2080B



Handy lid clips hold lid in place



Patented "Get-A-Grip" handle system

- ◆ Simple design with patented food pan that features safety handles, preventing steam burns
- ◆ Clips on frame conveniently hold cover when open
- ◆ Includes water pan, specially designed food pan and two fuel holders

ITEM	DESCRIPTION	UOM	CASE
C-2080B	8 Qt Full-Size	Set	1
C-WPF	Water Pan for C-2080B	Each	6
SPF2-HD	Food Pan with Handle for C-2080B	Each	6
C-F1	Fuel Holder with Cover	Each	12/48

**FOLDING CHAFERS**



C-1080

**SOLID FRAME CONSTRUCTION PROVIDES EXTRA STABILITY**



C-1080 Folding Frame

*For the on-the-go caterer, there are two full-size chafers with foldable frames available. The collapsible stand conveniently folds down and reassembles in seconds, great for space saving storage, and especially convenient for transporting food to events.*

- ◆ Constructed of stainless steel with built-in clips to hold covers in place for easy and convenient refilling and serving
- ◆ Each chafers set includes water pan, food pan, frame, cover and two fuel holders

**BELLAIRE HEAVYWEIGHT CHAFER**

- ◆ Sturdy and heavyweight, the sculpted legs on this folding chafers provide convenience without sacrificing elegance

ITEM	DESCRIPTION	UOM	CASE
C-1080	8 Qt Full-Size	Set	1
C-WPF	Water Pan for C-1080	Each	6
SPF2	Food Pan for C-1080, NSF	Each	6/12
C-F1	Fuel Holder with Cover	Each	12/48



C-4080



C-4080 Folding Frame

**ECONOMY-WEIGHT CHAFER**

- ◆ Lighter in weight for maximum mobility, the simple design of this chafers is versatile enough to serve up food at any event.

ITEM	DESCRIPTION	UOM	CASE
C-4080	8 Qt Full-Size	Set	1
C-WPF	Water Pan for C-4080	Each	6
SPF2	Food Pan for C-4080, NSF	Each	6/12
C-F1	Fuel Holder with Cover	Each	12/48



**SOUP WARMERS**

Enhance the look of a serving table with this stainless steel chafers-style soup warmer in 7 and 11 quart capacities.

- ◆ Includes cover, water pan and fuel holder

ITEM	DESCRIPTION	UOM	CASE
211	11 Qt Warmer	Set	1
207	7 Qt Warmer	Set	1
211-WP	Water Pan for 211	Each	12
207-WP	Water Pan for 207	Each	12
INS-11.0M	11 Qt Inset Pan for 211, 24 gauge	Each	6/12
INS-7.0M	7 Qt Inset Pan for 207, 24 gauge	Each	6/24
INSC-11M	Cover For 11 Qt Inset	Each	6/36
INSC-7M	Cover For 7 Qt Inset	Each	6/48
INSH-11	Hinged Cover For 11 Qt Inset	Each	6/24
INSH-7	Hinged Cover For 7 Qt Inset	Each	6/24

**SOUP WARMERS**



**ELECTRIC WATER PAN**

- ◆ Stands alone or fits standard full-size chafers for an electric alternative
- ◆ Can accommodate full-size steam table pans
- ◆ Adjustable temperature
- ◆ Food pan sold separately
- ◆ One year warranty

- ◆ Dimensions: 22-5/8"L x 13-5/8"W x 7"H

ITEM	DESCRIPTION	UOM	CASE
EWPP-2	Full-Size, 120V-60Hz, 900W, 7.5A, UL Certified	Each	1



Fits inside standard full-size chafers

**ELECTRIC WATER PAN**



EWPP-2



**CHAFFER STAND**

- ◆ Only fits steam table pans and water pans
- ◆ Do not use with aluminum foil pans

ITEM	DESCRIPTION	UOM	CASE
C-3F	Full-Size Stand	Each	10

**CHAFING PAN HOLDERS**

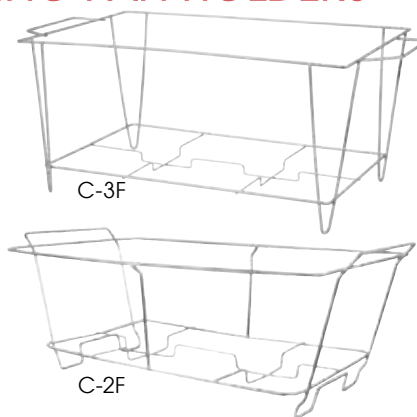

C-3F

C-2F



**CHAFFER STAND FOR ALUMINUM FOIL TRAYS**

ITEM	DESCRIPTION	UOM	CASE
C-2F	Full-Size Stand	Each	10



**CHAFFER FUEL CANS**

These wick-type reusable chafers fuel cans fit any standard fuel holder. The screw-on cap provides a secure seal for transporting and storage.

- ◆ Diethylene glycol fuel, wick-type
- ◆ Twist cap allows easy storage, reusable
- ◆ Recommended for chafing dishes and beverage urns
- ◆ Available in 2-, 4- and 6-hour burn time
- ◆ Sold in full case only

ITEM	DESCRIPTION	UOM	CASE
C-F2	Chafing Fuel, 2 Hour Burn Time	Each	24
C-F4	Chafing Fuel, 4 Hour Burn Time	Each	24
C-F6	Chafing Fuel, 6 Hour Burn Time	Each	24

**TWIST-CAP WICK FUEL CANS**



C-F6

C-F2



## VIRTUOSO COFFEE URNS

SEE PAGE 34  
FOR MATCHING  
VIRTUOSO  
CHAFERS

The modern design of the Virtuoso urns will add a stylish touch to any coffee and tea self-service station. The gleaming mirror-finish body is available in 3 gallon and 5 gallon capacities. A single fuel canister will keep contents warm and ready for dispensing.

- ◆ Made of extra-heavyweight stainless steel
- ◆ Available with gold accent legs or all stainless steel finish

### VIRTUOSO COFFEE URNS

ITEM	DESCRIPTION	UOM	CASE
905A	5 Gallon, Gold Legs	Set	1
905B	5 Gallon, S/S	Set	1
903A	3 Gallon, Gold Legs	Set	1
903B	3 Gallon, S/S	Set	1
FAUCET-CU	Stainless Steel Faucet	Each	1
FAUCET-JD	Plastic Faucet	Each	1



905A



903A



FAUCET-CU



FAUCET-JD



905B



903B

## PUNCH BOWL

### PUNCH BOWL

- ◆ Stainless steel mirror finish

ITEM	DESCRIPTION	UOM	CASE
SPB-35	3-1/2 Gal Punch Bowl with Decorative Ring Hdl	Each	6



SPB-35

The container of each dispenser holds up to 2.2 gallons and features an ice core in the center that keeps juices chilled without watering them down.

- ◆ Available in two-tone with gold accents or in all stainless steel
- ◆ Mirror finish
- ◆ Removable container and drip tray for easy cleaning
- ◆ Break-resistant polycarbonate containers

## JUICE DISPENSERS



### SINGLE JUICE DISPENSERS

ITEM	DESCRIPTION	UOM	CASE
901	Two-tone	Set	1
902	Stainless Steel	Set	1



901  
10-1/8"L x 13-3/4"W x 21-1/4"H

902  
10-1/8"L x 13-3/4"W x 21-1/4"H

### ACCESSORIES FOR JUICE DISPENSERS

ITEM	DESCRIPTION	UOM	CASE
901-FN	Faucet for 901, 902	Each	12
901-P1	PC Jar for 901, 902	Each	4



901-FN



901-P1

With oversized black letters on stainless steel, these beverage tent and chain signs are must-haves for buffets and beverage stations.

## STAINLESS STEEL BEVERAGE SIGNS

### TENT SIGNS

- ◆ 3"L x 1-1/4"H x 1-1/2"D

ITEM	DESCRIPTION	UOM	CASE
SGN-100	Blank Sign	Each	12/120
SGN-101	Hot Tea	Each	12/120
SGN-102	Decaf	Each	12/120
SGN-103	Coffee	Each	12/120
SGN-104	Hot Water	Each	12/120
SGN-105	Iced Tea	Each	12/120



SGN-SERIES TENT SIGNS

### CHAIN SIGNS

- ◆ 3-1/2"L x 1-3/4"W sign with 12" long chain

ITEM	DESCRIPTION	UOM	CASE
SGN-201	Hot Tea	Each	12/120
SGN-202	Decaf	Each	12/120
SGN-203	Coffee	Each	12/120
SGN-204	Hot Water	Each	12/120
SGN-205	Iced Tea	Each	12/120



SGN-SERIES CHAIN SIGNS



### DRIP TRAYS

- ◆ Dishwasher safe with removable grid.
- ◆ Each pack contains four (4) pieces
- ◆ BPA-free

ITEM	DESCRIPTION	UOM	CASE
DT-45	4-1/2" Tray, 4 pcs/pk	Pack	12/24
DT-60	6" Tray, 4 pcs/pk	Pack	12/24

## DRIP TRAYS



DT-45



DT-60

DT-SERIES



## DISPLAY TRAYS & RISERS



HRS-4

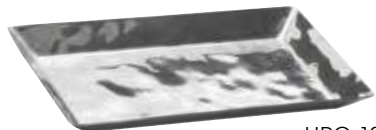

HPO-12

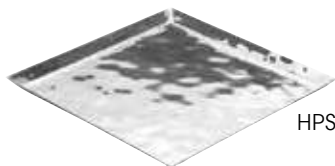

HPS-12



HPR-10

Made of 18/8 stainless steel, the surfaces of these trays and risers exhibit a glossy ripple effect in a gleaming mirror-finish, truly unique and elegant pieces for showcasing appetizers and desserts.

- ◆ Durable and stable surface for displaying
- ◆ Not recommended for prolonged use with acidic, creamy or salty ingredients
- ◆ Hand wash recommended

### NESTING RISER DISPLAY

- ◆ 4-piece nesting set

ITEM	DESCRIPTION	UOM	CASE
HRS-4	Riser 1: 5-1/2" x 5-1/2" x 5-1/2" Riser 2: 6-5/8" x 6-5/8" x 6-5/8" Riser 3: 7-7/8" x 7-7/8" x 7-7/8" Riser 4: 9" x 9" x 9"	Set	4

### DISPLAY TRAYS

- ◆ Available in a variety of shapes and sizes

ITEM	DESCRIPTION	SIZE	UOM	CASE
HPO-12	Rectangular	12-5/8" x 7-1/4" x 1"	Each	12
HPO-14	Rectangular	13-3/4" x 7-3/4" x 1"	Each	12
HPO-15	Rectangular	15" x 8-1/2" x 1"	Each	12
HPS-10	Square	10-1/4" x 10-1/4" x 5/8"	Each	12
HPS-12	Square	11-3/4" x 11-3/4" x 5/8"	Each	12
HPS-13	Square	13-1/4" x 13-1/4" x 5/8"	Each	12
HPR-8	Round	8-7/8"Dia x 1-5/8"	Each	12
HPR-9	Round	9-5/8"Dia x 1-5/8"	Each	12
HPR-10	Round	10-1/4"Dia x 1-5/8"	Each	12

## TIERED GLASS BOWL DISPLAYS



TDS-3



TDSF-4

## TIERED GLASS BOWL DISPLAYS

These multi-tiered glass bowl servers provide a modern and attractive way to display cold salads, fruits and breads.

- ◆ 18/8 stainless steel mirror-finish arms and bases
- ◆ Glass bowls are removable for easy cleaning, and microwave and dishwasher safe
- ◆ Available in 3-tier graduated set or 4-tier arm set
- ◆ Arms on the 4-tier set rotate 360°

ITEM	DESCRIPTION	UOM	CASE
TDS-3	3-Tier Set Base 9-7/8"Dia x 19-3/4"H	Set	1
TDSF-4	4-Tier Set Base 8-3/4"Dia x 20-1/2"H Bowl arms rotate 360°	Set	1
TDS-3-GLAS	Glass Bowl for TDS-3	Each	12
TDSF-4-GLS	Glass Bowl for TDSF-4	Each	12

**CHROME SERVING TRAYS**

The classic gadroon edge and traditional engraving of these chrome-plated trays are perfect for tea and coffee service, as well as pastries, appetizers and desserts.

- ◆ Available in a variety of shapes and sizes
- ◆ Not recommended for prolonged use with meat or acidic ingredients
- ◆ Hand wash only

ITEM	DESCRIPTION	SIZE	UOM	CASE
CMT-1912	Rectangular with Handles	19-1/2" x 12-1/2"	Each	12/24
CMT-1217	Octagonal	17" x 12-1/2"	Each	12/24
CMT-1420	Octagonal	20" x 14"	Each	12/24
CMT-1812	Rectangular	18" x 12-1/2"	Each	12/24
CMT-2014	Rectangular	20" x 14"	Each	12/24
CMT-1014	Oval	14-3/4" x 10-1/2"	Each	12/24
CMT-1318	Oval	18-3/4" x 13"	Each	12/24
CMT-14	Round	14"	Each	12/24



CMT-14



CMT-1318



CMT-1912



CMT-1420



CMT-2014

**CLIPS & HOLDERS**

**MENU HOLDER CLIPS**

ITEM	DESCRIPTION	SIZE	UOM	CASE
MH-1	Harp Clip, Heavy-Cast Base	1"L x 1"W x 1-1/2"H	Doz	10/60
MH-2	Ring-Type	2-1/2" x 2-1/3"	Doz	2/20
MH-2C	Clip	2-1/2" x 2-1/2"	Doz	40



MH-1



MH-2



MH-2C

**TABLE SIGN HOLDERS**

Stylish and discreet, these table sign holders are perfect for buffet and table seating.

ITEM	DESCRIPTION	UOM	CASE
TCD-2	Table Sign Holder, Cast Aluminum, 2 pcs/pk	Pack	24/240
TCD-3C	Table Sign Clip, "C" Base, 6 pcs/pk	Pack	4/96
TCD-3S	Table Sign Clip, "S" Base, 6 pcs/pk	Pack	4/96
TCD-4D	Table Sign Clip, Double Sided Clips, Flexible, 6 pcs/pk	Pack	48/192
TCD-4S	Table Sign Clip, Acrylic Square Base, 6 pcs/pk	Pack	4/48
TCD-4T	Table Sign Clip, Acrylic Triangle Base, 6 pcs/pk	Pack	4/48



TCD-2



TCD-3C



TCD-3S



TCD-4D



TCD-4S



TCD-4T

STAINLESS STEEL BUFFET SERVICE



BW-NS3 BW-SL2 BW-SS1 BW-BF BW-CF BW-PS5 BW-WPS6 BW-DL BW-DK8 BW-DK9 BW-SP1 BW-SP2 BW-TN



SHANGARILA SERVING PIECES



LE-1

LE-2

LE-4

LE-11

LE-13

LE-20



SRS-2



SRS-8



STS-9



STS-13

HOLLOW HANDLE BUFFETWARE

Plating and serving has never been easier than with our collection of hollow handle stainless steel buffetware.

ITEM	DESCRIPTION	LENGTH	UOM	CASE
BW-NS3	Notched Spoon	11-3/4"	Each	12/72
BW-SL2	Slotted Spoon	11-3/4"	Each	12/72
BW-SS1	Solid Spoon	11-3/4"	Each	12/72
BW-BF	Pot Fork, Two Tines	11"	Each	12/72
BW-CF	Cold Meat Fork	10"	Each	12/72
BW-PS5	Pie Server	11"	Each	12/72
BW-WPS6	Wide Pie Server	11-1/2"	Each	12/72
BW-DL	Deep Ladle	4 Oz	Each	12/72
BW-DK8	Carving Knife, Wave-Edge Blade	8"	Each	12/72
BW-DK9	Slicer/Wedding Cake Knife, Wave-Edge	9"	Each	12/72
BW-SP1	Spout Ladle	1 Oz	Each	12/72
BW-SP2	Spout Ladle	2 Oz	Each	12/72
BW-TN	Perforated Turner	14"	Each	12/72

SHANGARILA SERVING PIECES

◆ Extra heavyweight 18/8 stainless steel mirror finish

ITEM	DESCRIPTION	LENGTH	UOM	CASE
0030-21	Large Bowl Serving Spoon	9"	Doz	10
0030-22	Cold Meat Fork	8-1/2"	Doz	10
0030-23	Solid Spoon	11-1/2"	Doz	10
0030-24	Banquet Slotted Spoon	11-1/2"	Doz	10
0030-25	Banquet Fork	12"	Doz	10

ELEGANCE SERVING PIECES

ITEM	DESCRIPTION	LENGTH	UOM	CASE
LE-1	Gravy & Soup Ladle, 1 Oz	7"	Doz	36
LE-2	Gravy & Soup Ladle, 2 Oz	9"	Each	12/120
LE-4	Gravy & Soup Ladle, 4 Oz	13"	Each	12/120
LE-11	Solid Spoon	11"	Each	12/120
LE-13	Solid Spoon	13"	Each	12/120
LE-20	Fork	13"	Each	12/120

SERVING SPOONS

ITEM	DESCRIPTION	LENGTH	UOM	CASE
SRS-2	Round Edge	8-5/8"	Doz	25
SRS-8	Flat Edge	8-1/4"	Doz	25

SPAGHETTI SERVERS

ITEM	DESCRIPTION	LENGTH	UOM	CASE
STS-9	Small	9"	Each	12/144
STS-13	Large	13"	Each	12/144

**SERVING TONGS**

These heavyweight, 18/8 satin-finish stainless steel serving tongs are designed for comfortable service in elegant settings.

- ◆ Great for buffets, catered events and more
- ◆ Dishwasher safe

ITEM	DESCRIPTION	SIZE	UOM	CASE
STH-8	Short	8-1/2"	Each	12/72
STH-10	Medium	10-1/2"	Each	12/72
STH-13	Long	13-1/2"	Each	12/72

**STAINLESS STEEL SERVING TONGS**



**SALAD TONGS**

ITEM	DESCRIPTION	SIZE	UOM	CASE
PTOS-8	Oval Salad Tong, Satin Finish	7-3/4"	Each	12/96
ST-2	Double Spoon, Mirror Finish	10"	Each	6/60
ST-10	Fork and Spoon, Satin Finish	10"	Each	6/60
ST-10S	Slotted and Solid Spoon, Mirror Finish	10"	Each	12/96
ST-105SF	Spatula and Fork, Mirror Finish	10-1/2"	Each	12/96



**PASTRY TONGS**

ITEM	DESCRIPTION	SIZE	UOM	CASE
PT-8	Solid with Short Handle	7-1/2"	Each	12/120
PT-875	Solid with Long Handle	8-3/4"	Each	12/144
PT-10P	Perforated Scissor Style	10-1/2"	Each	12/96



**SPAGHETTI TONGS**

ITEM	DESCRIPTION	SIZE	UOM	CASE
ST-8	Mirror Finish	8"	Each	12/240



**ICE TONGS**

ITEM	DESCRIPTION	SIZE	UOM	CASE
ICT-7	Five Prong, Textured	7"	Each	12/144
IT-7	Three Prong, Satin Finish	7"	Each	12/120



**POM TONGS**

ITEM	DESCRIPTION	SIZE	UOM	CASE
PT-6	Satin Finish	6"	Doz	4/24
PT-9	Satin Finish	9"	Doz	4/24



**POLYCARBONATE  
SERVING UTENSILS**



**NSF** PUT-SERIES



PUTF-6K



**NSF** PPT-SERIES



PSSB-SERIES



**NSF** PSS-SERIES



**NSF** PLD-SERIES

**UTILITY TONGS**

ITEM	DESCRIPTION	SIZE	UOM	CASE
PUT-6B	Beige	6"	Each	12/192
PUT-6C	Clear	6"	Each	12/192
PUT-6K	Black	6"	Each	12/192
PUT-6R	Red	6"	Each	12/192
PUT-9B	Beige	9"	Each	12/144
PUT-9C	Clear	9"	Each	12/144
PUT-9K	Black	9"	Each	12/144
PUT-9R	Red	9"	Each	12/144
PUT-9W	White	9"	Each	12/144
PUT-12B	Beige	12"	Each	12/144
PUT-12C	Clear	12"	Each	12/144
PUT-12K	Black	12"	Each	12/144
PUT-12R	Red	12"	Each	12/144

**FLAT TONGS**

ITEM	DESCRIPTION	SIZE	UOM	CASE
PUTF-6B	Beige	6"	Each	12/432
<b>NSF</b> PUTF-6C	Clear, NSF	6"	Each	12/432
PUTF-6K	Black	6"	Each	12/432

**SPAGHETTI TONGS**

◆ Heat-resistant up to 302°F (150°C)

ITEM	DESCRIPTION	SIZE	UOM	CASE
PPT-11B	Beige	11"	Each	24/144
PPT-11C	Clear	11"	Each	24/144
PPT-11K	Black	11"	Each	24/144

**BUFFET SPOONS**

◆ 3/4 oz capacity

ITEM	DESCRIPTION	SIZE	UOM	CASE
PSSB-10B	Beige	10"	Each	12/384
<b>NSF</b> PSSB-10C	Clear, NSF	10"	Each	12/384
PSSB-10K	Black	10"	Each	12/384
PSSB-10R	Red	10"	Each	12/384

**SERVING SPOONS**

ITEM	DESCRIPTION	SIZE	UOM	CASE
PSS-13C	Clear	13"	Doz	12
PSS-13K	Black	13"	Doz	12
PSS-13R	Red	13"	Doz	12
PSS-15K	Black	15"	Doz	12

**ONE-PIECE LADLES**

ITEM	DESCRIPTION	CAPACITY	SIZE	UOM	CASE
PLD-8B	Beige	3/4 oz	8-1/2"	Each	12/192
PLD-8C	Clear	3/4 oz	8-1/2"	Each	12/192
PLD-8K	Black	3/4 oz	8-1/2"	Each	12/192
PLD-8R	Red	3/4 oz	8-1/2"	Each	12/192
PLD-13B	Beige	1 oz	13"	Each	12/192
PLD-13C	Clear	1 oz	13"	Each	12/192
PLD-13K	Black	1 oz	13"	Each	12/192
PLD-13R	Red	1 oz	13"	Each	12/192



Artfully present single-serve portions in copper and stainless steel finished tri-ply mini cookware.

- ◆ Tri-ply construction with either stainless steel or copper exterior, all induction ready
- ◆ Aluminum core provides efficient heat distribution
- ◆ 18/8 stainless steel cookware surface for superior cooking performance

## MINI COOKWARE



### TRI-PLY MINI COOKWARE WITH COPPER EXTERIOR

ITEM	DESCRIPTION	UOM	CASE
DCCR-3C	3.75" Casserole, 15 oz	Each	30
DCFP-4C	4" Fry Pan, 5 oz	Each	30
DCSC-3C	3" Saucier, 5 oz	Each	30
DCSP-3C	3.5" Sauce Pan, 11 oz	Each	30



### TRI-PLY MINI COOKWARE WITH STAINLESS STEEL EXTERIOR

ITEM	DESCRIPTION	UOM	CASE
DCCR-3S	3.75" Casserole, 15 oz	Each	30
DCFP-4S	4" Fry Pan, 5 oz	Each	30
DCSC-3S	3" Saucier, 5 oz	Each	30
DCSP-3S	3.5" Sauce Pan, 11 oz	Each	30

### TRI-PLY MINI COOKWARE LIDS

ITEM	DESCRIPTION	UOM	CASE
DCL-35	Lid for 3.5" DCSP, Sauce Pan	Each	50
DCL-375	Lid for 3.75" DCCR, Casserole	Each	50



MINI COOKWARE

AVAILABLE IN  
MAY 2017

NEW



DCWE-105S

NEW



DCWE-201C

NEW



DCWC-101S



DCWC-201C

NEW

NEW



DCWB-101S



DCWA-101S

NEW

NEW



DCWA-201C



DCWD-101S

NEW

NEW



DDSC-101S

Artfully cook and present single-serve portions in copper and stainless steel finish mini-ware.



STAINLESS STEEL MINI CASSEROLES

ITEM	DESCRIPTION	UOM	CASE
DCWE-101S	2-3/4" Dia x 1-3/4" H	Each	12/36
DCWE-102S	3-1/8" Dia x 1-3/4" H	Each	12/36
DCWE-103S	3-1/2" Dia x 2" H	Each	12/36
DCWE-104S	4-1/4" Dia x 2-3/8" H	Each	12/36
DCWE-105S	4-3/4" Dia x 3" H	Each	12/36



COPPER-PLATED MINI CASSEROLES

ITEM	DESCRIPTION	UOM	CASE
DCWE-201C	2-3/4" Dia x 1-3/4" H	Each	12/36
DCWE-202C	3-1/8" Dia x 1-3/4" H	Each	12/36
DCWE-203C	3-1/2" Dia x 2" H	Each	12/36
DCWE-204C	4-1/4" Dia x 2-3/8" H	Each	12/36
DCWE-205C	4-3/4" Dia x 3" H	Each	12/36



STAINLESS STEEL MINI FRY PANS

ITEM	DESCRIPTION	UOM	CASE
DCWC-101S	4" Dia x 1-1/8" H	Each	12/96
DCWC-102S	4-1/2" Dia x 1-3/8" H	Each	12/72
DCWC-103S	5" Dia x 1-1/8" H	Each	12/48



COPPER MINI FRY PAN

ITEM	DESCRIPTION	UOM	CASE
DCWC-201C	5-1/2" Dia x 1-3/8" H	Each	12/48



STAINLESS STEEL MINI TAPERED SAUCE PANS

ITEM	DESCRIPTION	UOM	CASE
DCWB-101S	2-3/4" Dia x 1-3/4" H	Each	12/72
DCWB-102S	3-3/8" Dia x 2-3/8" H	Each	12/72
DCWB-103S	4" Dia x 2-3/8" H	Each	12/48



STAINLESS STEEL MINI SAUCE PANS

ITEM	DESCRIPTION	UOM	CASE
DCWA-101S	2" Dia x 1-3/16" H	Each	12/120
DCWA-102S	2-3/4" Dia x 1-3/4" H	Each	12/120
DCWA-103S	3-1/8" Dia x 1-3/4" H	Each	12/96
DCWA-104S	3-1/2" Dia x 2" H	Each	12/48
DCWA-105S	4-3/8" Dia x 2-3/8" H	Each	12/48
DCWA-106S	5" Dia x 3" H	Each	12/48



COPPER-PLATED MINI SAUCE PANS

ITEM	DESCRIPTION	UOM	CASE
DCWA-201C	2" Dia x 1-3/16" H	Each	12/120
DCWA-202C	2-3/4" Dia x 1-3/4" H	Each	12/120
DCWA-203C	3-1/8" Dia x 1-3/4" H	Each	12/96
DCWA-204C	3-1/2" Dia x 2" H	Each	12/48
DCWA-205C	4-3/8" Dia x 2-3/8" H	Each	12/48
DCWA-206C	5" Dia x 3" H	Each	12/48



STAINLESS STEEL MINI WOKS

ITEM	DESCRIPTION	UOM	CASE
DCWD-101S	3-3/8" Dia x 1" H	Each	12/96
DCWD-102S	4" Dia x 1-3/16" H	Each	12/96



STAINLESS STEEL MINI COLANDERS

ITEM	DESCRIPTION	UOM	CASE
DDSC-101S	3-3/4" Dia	Each	12/120
DDSC-102S	4" Dia	Each	12/120
DDSC-103S	5-1/8" Dia	Each	12/72

### STAINLESS STEEL MINI ROASTING PANS

ITEM	DESCRIPTION	UOM	CASE
DDSB-101S	4-1/2" Sq	Each	12/72
DDSB-102S	5-3/16" Sq	Each	12/48
DDSB-103S	5"L x 3-3/8"W	Each	12/72
DDSB-104S	5-3/4"L x 3-3/4"W	Each	12/72

### MINI ROASTING PANS

← AVAILABLE IN MAY 2017



DDSB-101S **NEW**



DDSB-203C **NEW**

### COPPER-PLATED MINI ROASTING PANS

ITEM	DESCRIPTION	UOM	CASE
DDSB-201C	4-1/2" Sq	Each	12/72
DDSB-202C	5-3/16" Sq	Each	12/48
DDSB-203C	5"L x 3-3/8"W	Each	12/72
DDSB-204C	5-3/4"L x 3-3/4"W	Each	12/72

### KADY BOWLS

Elegantly serve saucy dishes in our stainless steel mirror-finish kady bowls.

- ◆ Durable stainless steel
- ◆ Elegant mirror finish
- ◆ Handles allow for easy transport of hot dishes
- ◆ Great for serving, displays and more

ITEM	DESCRIPTION	UOM	CASE
KDB-5	5"Dia	Each	6/96
KDB-6	6"Dia	Each	6/72
KDB-7	7"Dia	Each	6/48

### KADY BOWLS



KDB-7

### CARBON STEEL COOK & SERVEWARE

These Spanish-made, blini pans are ideal for adding a rustic look to fresh-cooked eggs or displaying individual Mediterranean dishes!

ITEM	DESCRIPTION	UOM	CASE
CSPP-4	4-3/4", Polished	Each	40
CSPP-4E	4-3/4", Non-Stick	Each	40

### MINI COOKWARE

INDUCTION READY

MADE IN SPAIN



CSPP-4 **NEW**

4-3/4" DIA. INDIVIDUAL SERVING SIZE



NON-STICK  
CSPP-4E **NEW**

## FRY CUPS

AVAILABLE IN  
MAY 2017

NEW

SFCW-4S



SFC-35



SFC-35H



WBKH-5



WBKH-10



## FRY CUPS

A sleek and trendy way to display side dishes. Perfect for serving fries, calamari, onion rings and other small portion finger foods!

- ◆ Durable satin-finish stainless steel
- ◆ Great for serving, displays and more
- ◆ 3-1/4" diameter x 3-1/2" high

ITEM	DESCRIPTION	UOM	CASE
SFC-35	Smooth Exterior	Each	12/120
SFC-35H	Hammered Exterior	Each	12/120



## FRY CUP WITH WIRE HOLDER

- ◆ Stainless steel



ITEM	DESCRIPTION	UOM	CASE
SFCW-4S	4"Dia	Set	12/48



## FRENCH FRY HOLDERS

ITEM	DESCRIPTION	UOM	CASE
WBKH-5	1-Cone, Holds 2 Oz Ramekins	Each	12
WBKH-10	3-Cone	Each	4

## MINI SERVING BASKETS



FBM-544T

FBM-32R

FBM-554S



## MINI SERVING BASKETS

Add some contemporary style to a buffet setting or tabletop dining with these mini baskets, a novel way to present and serve side dishes or appetizers.

- ◆ 18/8 stainless steel
- ◆ Great for serving individual portions
- ◆ Dishwasher safe

ITEM	DESCRIPTION	UOM	CASE
FBM-32R	Round, 3-3/4"Dia x 2-7/8"H	Each	12/72
FBM-443S	Square, 4"L x 4"W x 3"H	Each	12/72
FBM-554S	Square, 5"L x 5"W x 4"H	Each	12/72
FBM-433T	Rectangular, 4"L x 3"W x 3"H	Each	12/72
FBM-544T	Rectangular, 5"L x 4"W x 4"H	Each	12/72

## TACO SERVICE

BPA  
FREE

PTS-4



AVAILABLE IN  
MAY 2017



TCHS-23MN

NEW



## TACO SERVER

- ◆ Holds up to four (4) tacos
- ◆ Each pack comes with 2 pcs

ITEM	DESCRIPTION	UOM	CASE
PTS-4	8"L x 5"W x 2"H	Pack	16



## MINI TACO HOLDERS

- ◆ Stainless steel brushed finish



ITEM	DESCRIPTION	UOM	CASE
TCHS-12MN	1-2 Slots	Each	12/96
TCHS-23MN	2-3 Slots	Each	12/72



## TACO HOLDERS

- ◆ Also useful for dressing hot dogs
- ◆ Can flip over to accommodate different quantities
- ◆ Stainless steel brushed finish

ITEM	DESCRIPTION	UOM	CASE
TCHS-12	1-2 Slots	Each	12/96
TCHS-23	2-3 Slots	Each	12/72
TCHS-34	3-4 Slots	Each	12/48
TCHS-45	4-5 Slots	Each	12/36

TCHS-23



TCHS-12



TCHS-34



TCHS-45

### COPPER-PLATED MOSCOW MULE MUGS

Whether serving its classic namesake drink or any refreshing cocktails, these rustic copper-plated mugs will instantly keep drinks extra cold, making them great additions to an outdoor bar setting.

ITEM	DESCRIPTION	UOM	CASE
CMM-20	20 Oz, Smooth Exterior	Each	36
CMM-20H	20 Oz, Hammered Exterior	Each	36

### MOSCOW MULE MUGS



CMM-20

CMM-20H

### MINI MOSCOW MULE MUGS

The popular Moscow Mule Mugs are now available in mini versions! Also great for sauces.

ITEM	DESCRIPTION	UOM	CASE
CMM-2	2 Oz, Smooth, 4-Pcs/Pk	Pack	6/24
CMM-2H	2 Oz, Hammered, 4-Pcs/Pk	Pack	6/24



CMM-2



CMM-2H

AVAILABLE IN MAY 2017

### FRENCH PRESS

- ◆ Stainless steel frame with polypropylene handle
- ◆ Can also be used with loose leaf teas
- ◆ Glass carafe holds approximately 4 cups

ITEM	DESCRIPTION	UOM	CASE
FPCM-33	33 Oz, 3-3/4"Dia	Each	12

### COFFEE PRESS



FPCM-33

### STAINLESS STEEL MINT JULEP CUPS

ITEM	DESCRIPTION	UOM	CASE
DDSE-101S	3"Dia x 4-3/8"H	Each	12/72
DDSE-102S	3-3/8"Dia x 4-3/4"H	Each	12/72

### MINT JULEP CUPS



DDSE-101S

NEW

AVAILABLE IN MAY 2017

### STAINLESS STEEL MINI MILK CANS

ITEM	DESCRIPTION	UOM	CASE
DDSD-101S	2"Dia x 2"H	Each	12/144
DDSD-102S	2"Dia x 3-1/8"H	Each	12/72
DDSD-103S	3-1/8"Dia x 4"H	Each	12/36
DDSD-104S	3-1/8"Dia x 5"H	Each	12/36

### MINI MILK CANS & PAILS



DDSD-101S

NEW

AVAILABLE IN MAY 2017

### STAINLESS STEEL MINI PAILS

ITEM	DESCRIPTION	UOM	CASE
DDSA-101S	3"Dia x 3-1/8"H, Hammered	Each	12/72
DDSA-102S	3-1/2"Dia x 3-5/8"H, Hammered	Each	12/72
DDSA-103S	5"Dia x 5"H, Hammered	Each	12/48
DDSA-104S	3"Dia x 3-1/8"H	Each	12/72
DDSA-105S	3-1/2"Dia x 3-5/8"H	Each	12/72
DDSA-106S	3-3/4"Dia x 3-3/4"H	Each	12/72
DDSA-107S	5"Dia x 5"H	Each	12/48



DDSA-101S



DDSA-105S

NEW

## SERVING TRAYS

AVAILABLE IN  
MAY 2017

NEW



DDSH-102S

AVAILABLE IN  
MAY 2017

NEW



DDSI-102S



DDSI-101S

## STAINLESS STEEL MINI SERVING PLATTERS

ITEM	DESCRIPTION	UOM	CASE
DDSH-101S	6-5/8"L x 4-1/4"W	Each	12/72
DDSH-102S	8-1/2"L x 5-1/4"W	Each	12/72

## STAINLESS STEEL LONG SERVING TRAYS

ITEM	DESCRIPTION	UOM	CASE
DDSI-101S	14-1/8"L x 3-1/2"W	Each	12/48
DDSI-102S	14-1/8"L x 7-1/2"W	Each	12/24

## SERVING BOARDS

NEW



SBMW-117  
9" X 7", 2-1/2" HANDLE

NEW



SBMW-156  
11-1/2" X 6", 4-3/8" HANDLE

NEW



SBMW-157  
10-3/4" X 7", 4-1/2" HANDLE

## MARBLE & WOOD SERVING BOARDS

Add a rustic feel to any setting from buffets to sit-down dining. Ideal for serving cheeses, charcuterie, and other appetizers and desserts.

- ◆ The balance of white marble and acacia wood is perfect in both sophisticated and rustic settings
- ◆ Elegantly serve cheese plates, charcuterie and other hors d'oeuvres
- ◆ The cool surface is ideal for serving cheeses & fruits
- ◆ Hand wash only

ITEM	DESCRIPTION	UOM	CASE
SBMW-117	11-1/2" Overall Length	Each	6
SBMW-156	15-7/8" Overall Length	Each	6
SBMW-157	15-1/4" Overall Length	Each	6



- ◆ Professional grade, ideal for high-end kitchens or for white linen tabletops
- ◆ Premium quality beechwood
- ◆ Durable carbon steel grinder for clean, sharp cuts
- ◆ Long-lasting stainless steel internal mechanisms

## MAESTRO GOURMET PEPPERMILLS

**winco**  
*Maestro*



WPM-6CD WPM-8CD WPM-10CD WPM-12CD



Durable carbon steel grinder for clean, sharp cuts



WPM-6K WPM-8K

### MAESTRO MODERN

- ◆ Beautiful clean lines for upscale modern presentation

ITEM	DESCRIPTION	UOM	CASE
WPM-6CD	6"H	Each	48
WPM-8CD	8"H	Each	36
WPM-10CD	10"H	Each	24
WPM-12CD	12"H	Each	24

### MAESTRO REPLACEMENT KNOBS

ITEM	DESCRIPTION	UOM	CASE
WPM-6K	Knob for 6" Peppermills	Each	48
WPM-8K	Knob for 8" Peppermills	Each	48

### WOODEN PEPPERMILLS

- ◆ Rubberwood with zinc alloy grinder

ITEM	DESCRIPTION	UOM	CASE
WPM-08	8"H	Each	36
WPM-10	10"H	Each	24
WPM-12	12"H	Each	24
WPM-18	18"H	Each	12

## SALT & PEPPER



WPM-08 WPM-10 WPM-12 WPM-18

### SALT SHAKER & PEPPER GRINDER SET

- ◆ Rubberwood black matte finish
- ◆ 2-1/4" Dia x 6" H

ITEM	DESCRIPTION	UOM	CASE
SP-612	Salt & Pepper, 2-Pcs/Set	Set	24
SP-624	Pepper Mills, 2-Pcs/Set	Set	24



SP-612  
SALT & PEPPER

SP-624  
2 PEPPERMILLS



WPMP-6

### ACRYLIC PEPPERMILL/SALT SHAKER

ITEM	DESCRIPTION	UOM	CASE
WPMP-6	6"H	Each	72

## MINI CAST IRON WOK



NON-STICK

CSW-75

## CAST IRON CASSEROLE WOK

◆ Authentic cast iron wok in mini tabletop serving size

ITEM	DESCRIPTION	UOM	CASE
CSW-75	7"Dia x 2"H	Set	12

## PLATTER SERVERS



FS-2

ISP-3

## FAJITA SERVERS

◆ Improved plywood underliner resists splitting, chipping or cracking under the high-heat cast iron pan

ITEM	DESCRIPTION	UOM	CASE
FS-2	Fajita Server, 2-pc Set	Set	12
FS-2-UL	Replacement Underliner for FS-2, No Retail Pkg.	Each	12
ISP-3	Steak Platter with Gripper, 3-pc Set	Set	12
ISP-3-UL	Replacement Underliner for ISP-3, No Retail Pkg.	Each	12

◆ Wood underliner improved with layering construction  
◆ Platter and underliner sold separately

## ALUMINUM SIZZLING PLATTERS

ITEM	DESCRIPTION	UOM	CASE
APL-10	10" Platter	Each	12/48
APL-10UL	Wood Underliner for APL-10	Each	12
APL-11	11" Platter	Each	12/48
APL-11UL	Wood Underliner for APL-11	Each	12
APL-12	12" Platter	Each	12/36
APL-12UL	Wood Underliner for APL-12	Each	12

## STAINLESS STEEL SIZZLING PLATTERS

ITEM	DESCRIPTION	UOM	CASE
SIZ-11ST	11" Platter & Underliner Set	Set	12
SIZ-11	11" Oval Platter, S/S	Each	12/60
SWU-11	Underliner for SIZ-11	Each	12/36
SIZ-11BST	11" x 7" Platter & Underliner Set	Set	12
SIZ-11B	11" x 7" Rectangular Platter, S/S	Each	12/60
SWU-11B	Underliner for SIZ-11B	Each	12/36

## OVAL PLATTERS



OPL-14

## STAINLESS STEEL OVAL PLATTERS

ITEM	DESCRIPTION	UOM	CASE
OPL-12	11-3/4" x 7-7/8"	Each	10/60
OPL-14	13-5/8" x 9-1/2"	Each	10/60
OPL-16	15-7/8" x 10-1/2"	Each	10/40
OPL-18	17-7/8" x 12-1/4"	Each	10/30
OPL-20	19-5/8" x 13-1/2"	Each	10/20
OPL-22	21-5/8" x 15"	Each	12

## AU GRATIN DISHES



ADO-12

## AU GRATIN DISHES

◆ Stainless steel

ITEM	DESCRIPTION	UOM	CASE
ADO-8	8 Oz	Each	12/120
ADO-12	12 Oz	Each	12/144
ADO-15	15 Oz	Each	12/120
ADO-20	20 Oz	Each	12/72



### TORTILLA PRESSES

- ◆ Traditional press with excellent leverage
- ◆ Integrated handle allows for easy open and removal of corn/flour tortillas
- ◆ Great for making burritos, enchiladas and quesadillas

ITEM	DESCRIPTION	UOM	CASE
TPC-8A	8"Dia, Aluminum, Non-Stick	Each	6/12
TPC-8C	8"Dia, Cast Iron	Each	4



### TORTILLA WARMER

- ◆ Easy grip recessed handle
- ◆ Serve tortillas warm and fresh

ITEM	DESCRIPTION	UOM	CASE
PTW-8	8-1/2"Dia x 2-5/8"H	Each	12

### TORTILLA SERVICE



TPC-8A



TPC-8C



PTW-8

BPA FREE

Enhance South-of-the-Border dishes with our collection of Mexican-themed Molcajete salsa bowls and plate, tortilla warmer, and taco server. Made of BPA-free polypropylene, these rustic traditional style servers are break-resistant and dishwasher safe.

### MOLCAJETE SALSA BOWLS

- ◆ BPA-free

ITEM	DESCRIPTION	UOM	CASE
PMSB-4	4 Oz, 4-Pcs/Pk	Pack	24
PMSB-10	10 Oz, 4-Pcs/Pk	Pack	12
PMSB-56	56 Oz	Each	16

### SALSA & DIP SERVICE



PMSB-56



PMSB-10

PMSB-SERIES

BPA FREE



PMP-12

BPA FREE

### MOLCAJETE SALSA PLATE

- ◆ BPA-free

ITEM	DESCRIPTION	UOM	CASE
PMP-12	12 Oz, 2-Pcs/Pk	Set	16

## CONDIMENT HOLDERS



### BLACK WIRE CADDIES

ITEM	DESCRIPTION	UOM	CASE
WBKH-6SB	Flat Back, 8-1/4" x 6 1/4" x 9"H	Each	12
WBKH-6R	Round, 6-1/4"Dia x 9"H	Each	24
WBKH-7R	Round, 7-1/2"Dia x 9"H	Each	12



WBKH-6SB



WBKH-6R



WBKH-7R



WH-1

USE WITH PPH-SERIES, G-110, G-111



WH-2

### CHROME-PLATED HOLDERS

ITEM	DESCRIPTION	UOM	CASE
G-104S	Two 6 Oz Square Bottle Set w/Lids & Chrome-Plated Rack	Set	12
WH-1	Salt/Pepper Shakers & Sugar Packet Holder Rack (No Retail Pkg)	Each	12/48
WH-2	Sugar Packet Rack	Each	12/48
WH-3	Chrome-Plated Rack Holds 6 Oz Cruets (No Retail Pkg)	Each	12/48
WH-4	3-Ring Condiment Jar Rack	Each	12/48
WH-5	Rack Holds Two 6 Oz Sq Cruets	Each	12/72
WH-7	Salt/Pepper Shakers & Sugar Packets Rack	Each	12/72



G-104S  
USE WITH WH-3 AND (2)G-104



WH-3  
USE WITH G-104



WH-4  
USE WITH CJ-7P, CJ-7G



WH-5  
USE WITH G-104



WH-7  
USE WITH G-109



GOB-16S



GOB-8

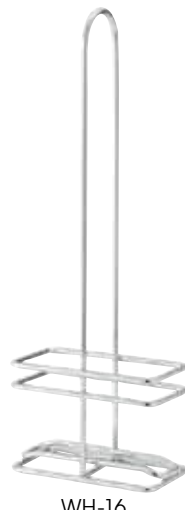

WH-16

### OIL & VINEGAR CRUETS

Also a great way to bottle and/or serve sauces and light syrups.

ITEM	DESCRIPTION	UOM	CASE
GOB-8S	2 Square 8 Oz Oil Bottles w/Lid & Chrome-Plated Rack	Set	12
GOB-16S	2 Square 16 Oz Oil Bottles w/Lid & Chrome-Plated Rack	Set	12
GOB-8	Square 8 Oz Oil Bottle w/Lid	Each	24
GOB-16	Square 16 Oz Oil Bottle w/Lid	Each	12
WH-8	Chrome Plated Rack, Fits GOB-8	Each	48
WH-16	Chrome Plated Rack, Fits GOB-16	Each	24

**SALT & PEPPER REFILLER JUGS**

◆ Spring loaded spout allows for quick refill of salt and pepper shakers

ITEM	DESCRIPTION	UOM	CASE
PR-05P	1/2 Gal Pepper Refiller	Each	24
PR-05S	1/2 Gal Salt Refiller	Each	24

**SALT & PEPPER REFILLERS**



PR-05P

PR-05S



G-100

G-101

G-102

G-103

G-104

G-105

G-106

**GLASS SHAKERS**

G-3 SERIES  
ATTRACTIVE RETAIL  
PACKAGING  
CONTAINS  
12PCS/BOX\*



G-107

G-108

G-109

G-110

G-111

G-117

G-118

G-115

G-116



G-3 SERIES

DESCRIPTION	SIZE	UOM	WHOLESALE BOX PACKAGING		RETAIL BOX PACKAGING		REPLACEMENT TOPS FOR SHAKERS		
			ITEM	CASE	ITEM	CASE	ITEM	DESCRIPTION	CASE
Square Shakers, S/S Tops	1/2 Oz	Doz	G-100	48	G-300	48	G-100C	For G-100 / G-300 / G-110	24/288
Square Shakers, Brass Tops	1/2 Oz	Doz	G-101	48			G-101C	For G-101 / G-301 / G-111	24/288
Sugar Pourers, Flap Tops	12 Oz	Doz	G-102	4	G-302	4	G-102C	For G-102 / G-302	4/48
Sugar Pourers, Perf Tops	12 Oz	Doz	G-103	4			G-103C	For G-103 / G-303	4/48
Oil/Vinegar Cruets	6 Oz	Doz	G-104	6	G-304	6	G-104C	For G-104 / G-304	24/216
Paneled Shakers, Mushroom Tops	1 Oz	Doz	G-105	10	G-305	12	G-105C	For G-105 / G-305	24/240
Paneled Shakers, Mushroom Tops	2 Oz	Doz	G-106	10	G-306	12	G-106C	For G-106 / G-306	24/240
Cheese Shakers, Perf Tops	6 Oz	Doz	G-107	5	G-307	6	G-107C	For G-107 / G-307	5/90
Cheese Shakers, Slotted Tops	6 Oz	Doz	G-108	5			G-108C	For G-108 / G-308	5/90
Square Shakers, Mushroom Tops	2 Oz	Doz	G-109	12	G-309	12	G-109C	For G-109 / G-308	12/96
Tower Shakers, S/S Tops	1 Oz	Doz	G-110	12	G-310	12			
Tower Shakers, Brass Tops	1 Oz	Doz	G-111	12					
Paneled Shakers, Mushroom Tops	3 Oz	Doz	G-117	12	G-317	12			
Classic Shakers, S/S Flat Tops	2 Oz	Doz	G-118	12	G-318	12			
Syrup Dispensers	6 Oz	*	G-115 (doz/box)	6					
Syrup Dispensers	14 Oz	*	G-116 (doz/box)	4	G-316 (4-Pcs/Box)	8			



## CONDIMENT DISPENSER



PKTS-2D

## CONDIMENT DISPENSER

Ideal for busy bars, food stands, convenience stores or fast-food service. Removable plastic inserts allow for easy cleaning.

- ◆ Durable 18/8 stainless steel, heavy duty pump
- ◆ Two (2) plastic inserts with 2 quart capacity
- ◆ Each pump full stroke draws out between 1 oz and 1-1/4 oz depending on viscosity
- ◆ Overall dimensions: 11"L x 8-3/4"W x 16"H (with pump)
- ◆ Assembly required

ITEM	DESCRIPTION	UOM	CASE
PKTS-2D	Condiment Dispenser with 2 Standard Pumps	Set	2
PKTS-PT01	Individual Pump with Lid	Each	1
PKTS-PT02	Replacement Plastic Jar	Each	1
PKTS-PT03	Stainless Steel Casing	Each	1

## SAUCE & DESSERT CUPS



FLUTED RFM-SERIES



PLAIN RP-SERIES



BLACK WHITE BONE

### NSF MELAMINE RAMEKINS



SCP-15 SCP-25 SCP-40



PSN-2

BPA FREE



ICC-5C

BPA FREE

## MELAMINE RAMEKINS

With a variety of colors and sizes available, the break-resistant melamine ramekin cups are ideal for high volume, fast-paced foodservice environments.

- ◆ NSF listed

ITEM	DESCRIPTION	SIZE	COLOR	UOM	CASE
RFM-1K	Fluted	1-1/2 Oz	Black	Doz	8
RFM-1W	Fluted	1-1/2 Oz	White	Doz	8
RFM-1B	Fluted	1-1/2 Oz	Bone	Doz	8
RFM-2K	Fluted	2 Oz	Black	Doz	8
RFM-2W	Fluted	2 Oz	White	Doz	8
RFM-2B	Fluted	2 Oz	Bone	Doz	8
RFM-3B	Fluted	3 Oz	Bone	Doz	8
RFM-3K	Fluted	3 Oz	Black	Doz	8
RFM-3W	Fluted	3 Oz	White	Doz	8
RFM-4B	Fluted	4 Oz	Bone	Doz	8
RFM-4K	Fluted	4 Oz	Black	Doz	8
RFM-4W	Fluted	4 Oz	White	Doz	8
RP-1B	Plain	1-1/2 Oz	Bone	Doz	8
RP-1K	Plain	1-1/2 Oz	Black	Doz	8
RP-1W	Plain	1-1/2 Oz	White	Doz	8
RP-2B	Plain	2 Oz	Bone	Doz	8
RP-2K	Plain	2 Oz	Black	Doz	8
RP-2W	Plain	2 Oz	White	Doz	8
RP-3B	Plain	3 Oz	Bone	Doz	8
RP-3K	Plain	3 Oz	Black	Doz	8
RP-3W	Plain	3 Oz	White	Doz	8
RP-4B	Plain	4 Oz	Bone	Doz	8
RP-4K	Plain	4 Oz	Black	Doz	8
RP-4W	Plain	4 Oz	White	Doz	8
RP-6B	Plain	6 Oz	Bone	Doz	8
RP-6K	Plain	6 Oz	Black	Doz	8
RP-6W	Plain	6 Oz	White	Doz	8

## STAINLESS STEEL SAUCE CUPS

ITEM	DESCRIPTION	UOM	CASE
SCP-15	1-1/2 Oz	Doz	48
SCP-25	2-1/2 Oz	Doz	48
SCP-40	4 Oz	Doz	48

## SYRUP/CREAM PITCHER

- ◆ Durable SAN plastic
- ◆ BPA-free
- ◆ 24-Pcs/Pk

ITEM	DESCRIPTION	UOM	CASE
PSN-2	2 Oz Pitcher	Pack	6/12

## CLEAR ICE CREAM & BERRY DISH

- ◆ BPA-free

ITEM	DESCRIPTION	UOM	CASE
ICC-5C	SAN, 5 Oz	Doz	16

### GRAVY BOATS

◆ Stainless steel

ITEM	DESCRIPTION	UOM	CASE
GBS-3	3 Oz	Each	12/72
GBS-5	5 Oz	Each	12/48
GBS-8	8 Oz	Each	12/36
GBS-10	10 Oz	Each	12/36

### CONDIMENT SERVICE



GBS-10

### SERVERS/CREAMERS

◆ Stainless steel

ITEM	DESCRIPTION	UOM	CASE
SCT-10	10 Oz w/Knob	Each	12/120
SCT-10F	10 Oz, Stackable Cover	Each	12/120



SCT-10F



SCT-10

### BELL CREAMERS

◆ Stainless steel

ITEM	DESCRIPTION	UOM	CASE
BCS-3	3 Oz	Each	12/144
BCS-5	5 Oz	Each	12/144
BCS-8	8 Oz	Each	12/144
BCS-10	10 Oz	Each	12/72



BCS-3



BCS-8

### SYRUP DISPENSERS & COLOR LIDS

- ◆ Stainless steel slide on lid prevents dripping
- ◆ PE bottles and interchangeable PP Lids
- ◆ Ideal for batter, dressing, juice and more

ITEM	DESCRIPTION	UOM	CASE
PSUD-32	32 Oz	Each	12
PSUD-48	48 Oz	Each	12
PSUD-WLid	Lid, White	Each	24/144
PSUD-RLid	Lid, Red	Each	24/144
PSUD-TLid	Lid, Tan	Each	24/144



PSUD-48

BPA FREE



PSUD-32

BPA FREE



NEW

PSUD-RLID



NEW

PSUD-TLID

### STAINLESS STEEL SWEETENER PACKET HOLDERS

ITEM	DESCRIPTION	UOM	CASE
DDSG-101S	3-3/16"L x 2-5/8"W Tray	Each	12/144
DDSG-102S	1-3/4" Square Cup	Each	12/144
DDSG-103S	2"Dia Round Cup	Each	12/216
DDSG-301S	2"Dia Rnd & 2" Square Sugar Packet Holder Set	Each	12/60



NEW

DDSG-301S

### PLASTIC SWEETENER PACKET HOLDERS

- ◆ 3-1/2" L x 2-1/2" W x 2" H
- ◆ NSF listed

ITEM	DESCRIPTION	UOM	CASE
PPH-1C	Clear	Doz	6
PPH-1K	Black	Doz	6
PPH-1W	White	Doz	6



PPH-SERIES

NSF

## CONDIMENT SERVICE



SBR-30



T-710



SD-5



SBW-35



CJ-2C



CJ-PC



CJ-7P



CJ-7G



RS-4



### ROLL-TOP SUGAR BOWL

◆ Stainless steel

ITEM	DESCRIPTION	UOM	CASE
SBR-30	20 Oz	Each	24

### SUGAR CAN

◆ Stainless steel

ITEM	DESCRIPTION	UOM	CASE
T-710	10 Oz	Each	72

### SHERBET DISHES

◆ Stainless steel

ITEM	DESCRIPTION	UOM	CASE
SD-3	3-1/2 Oz	Each	12/120
SD-5	5 Oz	Each	12/120

### BUTTER WARMER

◆ Set includes stand, butter cup, candle holder and candle

ITEM	DESCRIPTION	UOM	CASE
SBW-35	4-Pc Set	Set	48

### CONDIMENT JARS & COVERS

ITEM	DESCRIPTION	UOM	CASE
CJ-7P	7 Oz Jar, Plastic	Doz	6
CJ-2C	Slotted Cover for CJ-7P, S/S	Each	36/144
CJ-7G	7 Oz Jar, Glass	Doz	3
CJ-PC	Slotted Cover for CJ-7G, Plastic	Doz	24

### RELISH SERVERS

ITEM	DESCRIPTION	UOM	CASE
RS-3	3 Compartments	Set	24
RS-4	4 Compartments	Set	24



## SNAIL SERVICE



SND-6

### SNAIL SERVICE

◆ Neatly serve escargot

◆ Stainless steel

ITEM	DESCRIPTION	UOM	CASE
SND-6	Dish, 6 Holes	Each	12/144
SND-T6	Tong	Each	12/120
SND-F7	Fork	Doz	50



SND-T6



SND-F7

## SEAFOOD TRAYS

Create an enticing tabletop spread with these trays in assorted sizes for displaying shrimp, seafood or tasty appetizers. The brushed aluminum construction retains cold and keeps foods at safe serving temperatures.

ITEM	DESCRIPTION	UOM	CASE
ASFT-12	12"Dia x 1-1/2"H	Each	12/36
ASFT-14	13-3/4"Dia x 1-1/2"H	Each	12/36
ASFT-16	15-3/4"Dia x 1-1/2"H	Each	12/24
ASFT-18	17-3/4"Dia x 1-1/2"H	Each	12/24
ASFT-20	19-3/4"Dia x 1-1/2"H	Each	12

## SEAFOOD TRAYS



ASFT-12

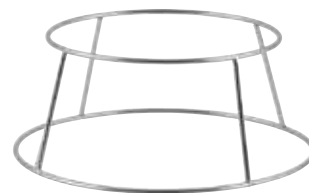

SFR-4



### CHROME-PLATED SEAFOOD TRAY RACKS

- ◆ Use with ASFT-series seafood trays to create appealing tabletop presentations
- ◆ Also perfect for elevating serving plates, bowls and platters, as well as holding pizza pans

ITEM	DESCRIPTION	UOM	CASE
SFR-4	7-3/8" Top Dia / 9-5/8" Bottom Dia x 4-3/8"H	Each	20
SFR-7	7-3/8" Top Dia / 9-5/8" Bottom Dia x 7"H	Each	20

## PEARL SHELL BOWLS

Made of light-weight ABS plastic, these shell bowls are ideal for displaying cold foods and salads.

ITEM	DESCRIPTION	UOM	CASE
PSBW-1W	20 Oz	Each	12/48
PSBW-5W	5 Qt	Each	6/12

## SALAD BOWLS



PSBW-1W

PSBW-5W

### PEBBLED SALAD BOWLS

- ◆ Made of durable polycarbonate, these clear pebbled bowls are perfect for salads, fruits, desserts and snacks
- ◆ NSF listed

ITEM	DESCRIPTION	UOM	CASE
PBB-6	6"	Each	96
PBB-8	8"	Each	48
PBB-10	10"	Each	24
PBB-12	12"	Each	24
PBB-15	15"	Each	12
PBB-18	18"	Each	12



PBB-10

PBB-SERIES 

### WOODEN SALAD BOWLS

- ◆ Hand wash only
- ◆ Also good for chips and snacks

ITEM	DESCRIPTION	UOM	CASE
WWB-5	5"	Each	12/288
WWB-6	6"	Each	12/288
WWB-8	8"	Each	12/144
WWB-10	10"	Each	12/96
WWB-12	12"	Each	12/72
WWB-14	14"	Each	12/36
WWB-16	16"	Each	12/24
WWB-18	18"	Each	12
WWB-20	20"	Each	12



WWB-SERIES



## TABLETOP BASKETS



PWBN-118T



PWBK-1914T

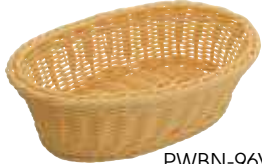

PWBN-96V

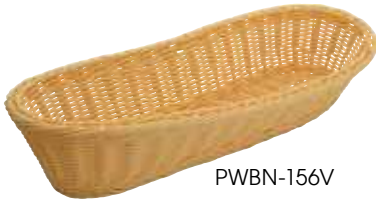

PWBN-156V



PWBK-88R



PWBK-94B



PWBN-SERIES



PWBN-16B



PWBK-SERIES



## SOLID-CORD POLY WOVEN BASKETS

- ◆ Flexible with reinforced weaving on rim and base for added durability
- ◆ Easily stackable
- ◆ Dishwasher safe

ITEM	DESCRIPTION	SIZE	COLOR	UOM	CASE
PWBK-118T	Rectangular, 12-Pcs/Pk	11-1/2" x 8-1/2" x 3-1/2"	Black	Pack	2
PWBN-118T	Rectangular, 12-Pcs/Pk	11-1/2" x 8-1/2" x 3-1/2"	Natural	Pack	2
PWBK-1914T	Rectangular with Handles, 3-Pcs/Pk	19" x 14" x 4"	Black	Pack	4
PWBN-1914T	Rectangular with Handles, 3-Pcs/Pk	19" x 14" x 4"	Natural	Pack	4
PWBK-96V	Oval, 6-Pcs/Pk	9-1/4" x 6-1/4" x 3-1/4"	Black	Pack	12
PWBN-96V	Oval, 6-Pcs/Pk	9-1/4" x 6-1/4" x 3-1/4"	Natural	Pack	12
PWBK-156V	Oval, 6-Pcs/Pk	15" x 6-1/2" x 3-1/4"	Black	Pack	6
PWBN-156V	Oval, 6-Pcs/Pk	15" x 6-1/2" x 3-1/4"	Natural	Pack	6
PWBK-88R	Round, 12-Pcs/Pk	8-1/4" x 3-1/4"	Black	Pack	3
PWBN-88R	Round, 12-Pcs/Pk	8-1/4" x 3-1/4"	Natural	Pack	3
PWBK-94B	Oval, 6-Pcs/Pk	9" x 4-1/2" x 3"	Black	Pack	12
PWBN-94B	Oval, 6-Pcs/Pk	9" x 4-1/2" x 3"	Natural	Pack	12

## TAN POLY WOVEN BASKETS

ITEM	DESCRIPTION	SIZE	UOM	CASE
PWBN-9B	Long Oval	9" x 4-1/4" x 2"	Doz	12
PWBN-9R	Round	9" x 2-3/4"	Doz	12
PWBN-9V	Oval	9-1/2" x 6-1/2" x 2-3/4"	Doz	12

## NATURAL WOVEN BASKETS

ITEM	DESCRIPTION	SIZE	UOM	CASE
PWBN-12B	Rectangle with Handles	12" x 8" x 3"	Each	12/96
PWBN-16B	Rectangle with Handles	16" x 11" x 3"	Each	12/48

## BLACK/GOLD POLY WOVEN BASKETS

- ◆ Wire reinforced

ITEM	DESCRIPTION	SIZE	UOM	CASE
PWBK-8R	Round	8-1/4" x 2-1/4"	Doz	12
PWBK-9B	Long Oval	8-3/4" x 3-7/8" x 2"	Doz	12
PWBK-9V	Oval	9" x 7" x 2-3/4"	Doz	12





### BREAD BASKETS

ITEM	DESCRIPTION	SIZE	UOM	CASE
WBKG-9	Rectangular	9" x 5-7/8" x 3"	Each	24
WBKG-8R	Round	8"	Each	48
WBKG-10O	Oval	10" x 6-1/2" x 3"	Each	24
WBKG-10R	Round	10"	Each	12
WBKG-15	Long Oval	15" x 6-1/4" x 3"	Each	12

### BLACK WIRE SERVING BASKETS



WBKG-9



WBKG-10O



WBKG-15



WBKG-10R



### PLASTIC OVAL PLATTERS

- ◆ Sturdy BPA-free poly plastic
- ◆ Great for bread, appetizers, sandwiches and fries
- ◆ Dishwasher safe

ITEM	DESCRIPTION (L X W X H)	COLOR	UOM	CASE
PLB-G	10-3/4" x 7-1/4" x 1-1/2"	Green	Doz	12
PLB-K	10-3/4" x 7-1/4" x 1-1/2"	Black	Doz	12
PLB-R	10-3/4" x 7-1/4" x 1-1/2"	Red	Doz	12
PLB-Y	10-3/4" x 7-1/4" x 1-1/2"	Yellow	Doz	12

### FAST FOOD BASKETS



PLB-SERIES



### PREMIUM PLASTIC OVAL BASKETS

- ◆ Sturdy BPA-free poly plastic
- ◆ Great for fast dining establishments
- ◆ Choice of five (5) colors
- ◆ Dishwasher safe

ITEM	DESCRIPTION (L X W X H)	COLOR	UOM	CASE
POB-G	10-1/4" x 6-3/4" x 2"	Green	Doz	12
POB-K	10-1/4" x 6-3/4" x 2"	Black	Doz	12
POB-R	10-1/4" x 6-3/4" x 2"	Red	Doz	12
POB-Y	10-1/4" x 6-3/4" x 2"	Yellow	Doz	12
PFB-10B	9-1/2" x 5" x 2"	Brown	Doz	3
PFB-10G	9-1/2" x 5" x 2"	Green	Doz	3
PFB-10R	9-1/2" x 5" x 2"	Red	Doz	3



POB-SERIES



PFB-SERIES



# MELAMINE COLLECTION

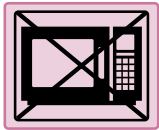

NOT FOR OVEN OR MICROWAVE USE



DISHWASHER SAFE



MELAMINE COLLECTION



MMPR-10



MMPR-10W



MMPO-118



MMPO-118W



MMPT-117



MMPT-117W



MMB-22



MMB-22W

Break-resistant and built to withstand the rigors of everyday use in fast paced foodservice establishments, the Winco Melamine Collection comes in classic tan and white. Ideal for salad bars and buffets because of its great cold insulation, melamine also stays cool to the touch, allowing for hot entrée service without getting burned.

- ◆ Not suitable for microwave or oven use
- ◆ Heat resistant up to 212°F (100°C)
- ◆ NSF listed

## ROUND PLATES

ITEM	SIZE	COLOR	UOM	CASE
MMPR-5	5-1/2" Dia	Tan	Doz	8
MMPR-5W	5-1/2" Dia	White	Doz	8
MMPR-6	6-1/2" Dia	Tan	Doz	4
MMPR-6W	6-1/2" Dia	White	Doz	4
MMPR-7	7-1/4" Dia	Tan	Doz	8
MMPR-7W	7-1/4" Dia	White	Doz	8
MMPR-8	8" Dia	Tan	Doz	4
MMPR-8W	8" Dia	White	Doz	4
MMPR-9	9" Dia	Tan	Doz	4
MMPR-9W	9" Dia	White	Doz	4
MMPR-10	10-1/4" Dia	Tan	Doz	2
MMPR-10W	10-1/4" Dia	White	Doz	2

## OVAL PLATTERS WITH NARROW RIM

ITEM	SIZE	COLOR	UOM	CASE
MMPO-96	9-3/4"L x 6-3/4"W	Tan	Doz	2
MMPO-96W	9-3/4"L x 6-3/4"W	White	Doz	2
MMPO-118	11-1/2"L x 8"W	Tan	Doz	2
MMPO-118W	11-1/2"L x 8"W	White	Doz	2
MMPO-138	13"L x 8"W	Tan	Doz	2
MMPO-138W	13"L x 8"W	White	Doz	2
MMPO-139	13-1/4"L x 9-5/8"W	Tan	Doz	4
MMPO-139W	13-1/4"L x 9-5/8"W	White	Doz	4
MMPO-1510	15-1/2"L x 10-7/8"W	Tan	Doz	2
MMPO-1510W	15-1/2"L x 10-7/8"W	White	Doz	2

## RECTANGULAR PLATTERS

ITEM	SIZE	COLOR	UOM	CASE
MMPT-96	9-1/2"L x 6-3/4"W	Tan	Doz	4
MMPT-96W	9-1/2"L x 6-3/4"W	White	Doz	4
MMPT-117	11-1/2"L x 7-1/2"W	Tan	Doz	4
MMPT-117W	11-1/2"L x 7-1/2"W	White	Doz	4
MMPT-129	12-1/2"L x 9"W	Tan	Doz	2
MMPT-129W	12-1/2"L x 9"W	White	Doz	2
MMPT-1510	15"L x 10-5/8"W	Tan	Doz	2
MMPT-1510W	15"L x 10-5/8"W	White	Doz	2

## RIMLESS BOWLS

ITEM	SIZE	CAPACITY	COLOR	UOM	CASE
MMB-22	6-7/8" Dia	22 oz	Tan	Doz	2
MMB-22W	6-7/8" Dia	22 oz	White	Doz	2
MMB-32	7-1/2" Dia	32 oz	Tan	Doz	4
MMB-32W	7-1/2" Dia	32 oz	White	Doz	4
MMB-41	8" Dia	41 oz	Tan	Doz	4
MMB-41W	8" Dia	41 oz	White	Doz	4
MMB-52	8-3/4" Dia	52 oz	Tan	Doz	4
MMB-52W	8-3/4" Dia	52 oz	White	Doz	4
MMB-70	9-3/4" Dia	70 oz	Tan	Doz	2
MMB-70W	9-3/4" Dia	70 oz	White	Doz	2
MMB-96	11" Dia	96 oz	Tan	Doz	2
MMB-96W	11" Dia	96 oz	White	Doz	2



## NAPPIES

ITEM	SIZE	CAPACITY	COLOR	UOM	CASE
MMB-11	4-7/8" Dia	11 oz	Tan	Doz	8
MMB-11W	4-7/8" Dia	11 oz	White	Doz	8
MMB-15	5-1/4" Dia	15 oz	Tan	Doz	8
MMB-15W	5-1/4" Dia	15 oz	White	Doz	8



MMB-15



MMB-15W



## SAUCE CUPS/RAMEKINS

ITEM	SIZE	CAPACITY	COLOR	UOM	CASE
MMSC-2	2-7/8" Dia	2-1/2 oz	Tan	Doz	24
MMSC-2W	2-7/8" Dia	2-1/2 oz	White	Doz	24
MMSC-4	3-1/4" Dia	4 oz	Tan	Doz	12
MMSC-4W	3-1/4" Dia	4 oz	White	Doz	12



MMSC-2



MMSC-2W



## BOUILLON CUPS

ITEM	SIZE	CAPACITY	COLOR	UOM	CASE
MMB-8	3-7/8" Dia	8 oz	Tan	Doz	4
MMB-8W	3-7/8" Dia	8 oz	White	Doz	4



MMB-8



MMB-8W



## FRUIT BOWLS

ITEM	SIZE	CAPACITY	COLOR	UOM	CASE
MMB-4	4-3/4" Dia	4 oz	Tan	Doz	8
MMB-4W	4-3/4" Dia	4 oz	White	Doz	8
MMB-5	4-3/4" Dia	5 oz	Tan	Doz	4
MMB-5W	4-3/4" Dia	5 oz	White	Doz	4



MMB-4



MMB-5W



## GRAPEFRUIT BOWLS

ITEM	SIZE	CAPACITY	COLOR	UOM	CASE
MMB-10	5-1/2" Dia	10 oz	Tan	Doz	8
MMB-10W	5-1/2" Dia	10 oz	White	Doz	8
MMB-13	5-3/4" Dia	13 oz	Tan	Doz	4
MMB-13W	5-3/4" Dia	13 oz	White	Doz	4



MMB-13



MMB-13W



## SOUP/CEREAL BOWLS

ITEM	SIZE	CAPACITY	COLOR	UOM	CASE
MMB-12	6-3/8" Dia	12 oz	Tan	Doz	8
MMB-12W	6-3/8" Dia	12 oz	White	Doz	8



MMB-12



MMB-12W



## BULBOUS MUGS

◆ 3-1/2"L x 2-15/16"W/Dia x 3-5/8"H

ITEM	SIZE	CAPACITY	COLOR	UOM	CASE
MMU-8	2-15/16" Dia	8oz	Tan	Doz	4
MMU-8W	2-15/16" Dia	8oz	White	Doz	4



MMU-8



MMU-8W



## MENU COVERS



Full size menu cover styles available in 3 colors

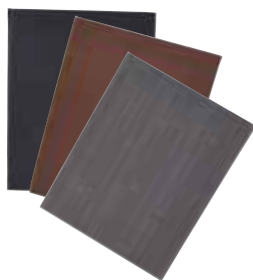

Chic leatherette menu covers provide an elegant yet durable display for full-service or fast casual restaurants alike. The refined double-sided stitched menu covers offer the look of a customized menu without the customization wait times - a timeless style in a full collection to complement any décor.

- ◆ Features secure interior picture corners
- ◆ Available for both letter and legal size pages
- ◆ Three neutral color choices and patterns
- ◆ Most common sizes and page configurations available

NEW SIZE



LMS-414BK  
Bar size

LMS-814GY  
Legal size

LMS-811GY  
Letter size



Picture corners



### SINGLE-VIEW MENU COVERS

- ◆ Great for lunch or tapas menus, drink specials and desserts
- ◆ LMS-414BK fits 4-1/2" x 14" paper
- ◆ LMS-811 series fits 8-1/2" x 11" letter size paper
- ◆ LMS-814 series fits 8-1/2" x 14" legal size paper

ITEM	DESCRIPTION	COLOR	UOM	CASE
LMS-811BK	Letter Size	Black	Each	50
LMS-811BN	Letter Size	Brown	Each	50
LMS-811GY	Letter Size	Gray	Each	50
LMS-814BK	Legal Size	Black	Each	50
LMS-814BN	Legal Size	Brown	Each	50
LMS-814GY	Legal Size	Gray	Each	50
LMS-414BK	Bar Size	Black	Each	50



### TWO-VIEW MENU COVERS

- ◆ Perfect for most upscale dinner menus highlighting the finest of chef's creations
- ◆ LMD-811 series fits 8-1/2" x 11" letter size paper
- ◆ LMD-814 series fits 8-1/2" x 14" legal size paper

ITEM	DESCRIPTION	COLOR	UOM	CASE
LMD-811BK	Letter Size	Black	Each	30
LMD-811BN	Letter Size	Brown	Each	30
LMD-811GY	Letter Size	Gray	Each	30
LMD-814BK	Legal Size	Black	Each	30
LMD-814BN	Legal Size	Brown	Each	30
LMD-814GY	Legal Size	Gray	Each	30



LMD-814BK  
Two-view  
Legal size



### FOUR-VIEW MENU COVERS

- ◆ Ideal for most casual restaurant establishments with an extensive variety of menu items
- ◆ LMF-811 series fits 8-1/2" x 11" letter size paper
- ◆ LMF-814 series fits 8-1/2" x 14" legal size paper

ITEM	DESCRIPTION	COLOR	UOM	CASE
LMF-811BK	Letter Size	Black	Each	30
LMF-811BN	Letter Size	Brown	Each	30
LMF-811GY	Letter Size	Gray	Each	30
LMF-814BK	Legal Size	Black	Each	30
LMF-814BN	Legal Size	Brown	Each	30
LMF-814GY	Legal Size	Gray	Each	30



LMF-814GY  
Four-view  
Legal size



### MENU TENTS

- ◆ Highlight specials or drinks with either our dual or 3-sided tent menus
- ◆ Easily change out promotional menus on these durable tabletop holders
- ◆ 5" x 7" paper fits in menu tents

ITEM	DESCRIPTION	UOM	CASE
LMTD-57BK	Dual-View	Each	50
LMTT-57BK	Triple-View	Each	50



LMTD-57BK



LMTT-57BK

The edgings on all Winco® menu covers are double stitched to hold up to the wear and tear of constant, daily handling.

## MENU COVERS & HOLDERS

### SINGLE POCKET MENU COVERS

- ◆ PMC-5 series fits 5" x 8" paper
- ◆ PMC-9 series fits 8-1/2" x 11" paper
- ◆ PMC-14 series fits 8-1/2" x 14" paper

ITEM	DESCRIPTION	UOM	CASE
PMC-5K	Black 6-3/8" x 9-3/8"	Each	25/200
PMC-5U	Burgundy 6-3/8" x 9-3/8"	Each	25/200
PMC-9B	Blue 9-5/16" x 12-1/8"	Each	25/200
PMC-9K	Black 9-5/16" x 12-1/8"	Each	25/200
PMC-9R	Red 9-5/16" x 12-1/8"	Each	25/200
PMC-9U	Burgundy 9-5/16" x 12-1/8"	Each	25/200
PMC-9G	Green 9-5/16" x 12-1/8"	Each	25/200
PMC-14K	Black 9-3/8" x 14-7/8"	Each	25/100
PMC-14U	Burgundy 9-3/8" x 14-7/8"	Each	25/100



PMC-SERIES

### BOOK-FOLD DOUBLE PANEL MENU COVERS

- ◆ PMCD-9 series fits 8-1/2" x 11" paper
- ◆ PMCD-14 series fits 8-1/2" x 14" paper

ITEM	DESCRIPTION	UOM	CASE
PMCD-9B	Blue 9-3/8" x 12-1/8"	Each	25/100
PMCD-9K	Black 9-3/8" x 12-1/8"	Each	25/100
PMCD-9R	Red 9-3/8" x 12-1/8"	Each	25/100
PMCD-9U	Burgundy 9-3/8" x 12-1/8"	Each	25/100
PMCD-9G	Green 9-3/8" x 12-1/8"	Each	25/100
PMCD-14K	Black 9-9/16" x 15"	Each	25/100
PMCD-14U	Burgundy 9-9/16" x 15"	Each	25/100



PMCD-9K

### TRI-FOLD TRIPLE PANEL MENU COVERS

- ◆ PMCT-9 fits 8-1/2" x 11" paper

ITEM	DESCRIPTION	UOM	CASE
PMCT-9B	Blue 9-1/2" x 12-1/8"	Each	25/50
PMCT-9K	Black 9-1/2" x 12-1/8"	Each	25/50
PMCT-9R	Red 9-1/2" x 12-1/8"	Each	25/50
PMCT-9G	Green 9-1/2" x 12-1/8"	Each	25/50
PMCT-9U	Burgundy 9-1/2" x 12-1/8"	Each	25/50



PMCT-9K

### FOUR POCKET BLACK MENU COVER

- ◆ PMCF-9 fits 8-1/2" x 11" paper

ITEM	DESCRIPTION	UOM	CASE
PMCF-9K	9-5/8" x 12-1/8"	Each	25/50



PMCF-9K

### DOUBLE SIDED CLEAR ACRYLIC MENU STANDS

- ◆ 2.0mm thickness

ITEM	DESCRIPTION	UOM	CASE
ATCH-46	4" x 6"	Each	12/36
ATCH-53	5-1/2" x 3-1/2"	Each	12/48
ATCH-57	5" x 7"	Each	12/36
ATCH-811	8" x 11"	Each	12/24



ATCH-811

## SIGN CLIPS & HOLDERS



TBH-12



TBN-SERIES



MH-1



MH-2



MH-2C



TCD-2



TCD-3C



TCD-3S



TCD-4D



TCD-4S



TCD-4T

## TABLE NUMBER HOLDERS

◆ Mirror finish chrome-plated steel

ITEM	DESCRIPTION	UOM	CASE
TBH-8	8"	Each	12/120
TBH-12	12"	Each	12/120
TBH-15	15"	Each	12/120
TBH-18	18"	Each	12/120

## PLASTIC TABLE NUMBERS

◆ Numbers printed on both sides

◆ Measures 4" x 3-3/4"

ITEM	DESCRIPTION	UOM	CASE
TBN-25	Numbers 1-25	Set	200
TBN-50	Numbers 1-50	Set	100
TBN-100	Numbers 1-100	Set	50

## MENU HOLDER CLIPS

ITEM	DESCRIPTION	UOM	CASE
MH-1	Harp Clip, Heavy-Cast Base, 1"L x 1"W x 1-1/2"H	Doz	10/60
MH-2	Ring-Type, 2-1/2" x 2-1/3"	Doz	2/20
MH-2C	Clip, 2-1/2" x 2-1/2"	Doz	40



## TABLE SIGN HOLDERS

*Stylish and discreet, these table sign holders are perfect for buffet and table seating.*

ITEM	DESCRIPTION	UOM	CASE
TCD-2	Table Sign Holder, Cast Aluminum, 2-Pcs/Pk	Pack	24/240
TCD-3C	Table Sign Clip, "C" Base, 6-Pcs/Pk	Pack	4/96
TCD-3S	Table Sign Clip, "S" Base, 6-Pcs/Pk	Pack	4/96
TCD-4D	Table Sign Clip, Double Sided Clips, Flexible, 6-Pcs/Pk	Pack	48/192
TCD-4S	Table Sign Clip, Acrylic Square Base, 6-Pcs/Pk	Pack	4/48
TCD-4T	Table Sign Clip, Acrylic Triangle Base, 6-Pcs/Pk	Pack	4/48

## WINE SERVICE

### 4 QT WINE BUCKETS & STAND

◆ Stainless steel mirror finish

ITEM	DESCRIPTION	SIZE	UOM	CASE
WB-4	4 Qt Wine Bucket, No Retail Pkg.	7-1/2" Dia x 8" H	Each	6/24
WB-4HV	4 Qt Deluxe Wine Bucket	8" Dia x 10" H	Each	12
WB-29S	Pipe Style Stand for WB-4 & WB-4HV	28-1/2" H	Each	6



### 8 QT WINE BUCKET & STANDS

◆ Stainless steel mirror finish

ITEM	DESCRIPTION	UOM	CASE
WB-8	8 Qt Wine Bucket*	Each	6/24
WB-8S	Stand for WB-8	Each	12
WB-12FS	Folding Stand for WB-8	Each	6

\*Assembly required

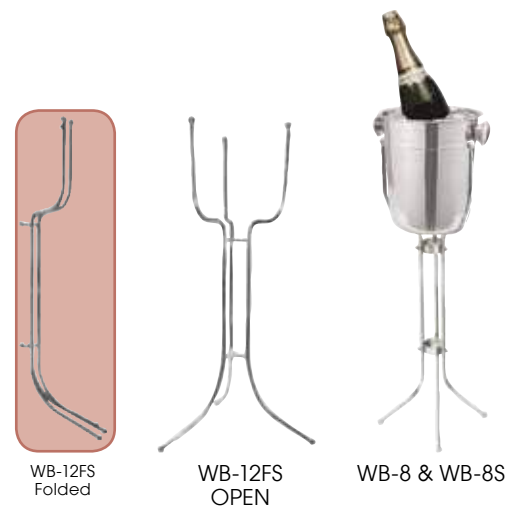

### DOUBLE WALL WINE COASTERS

- ◆ Great space saving alternative to wine buckets
- ◆ Can also be used to display light snacks, hors d'oeuvres or desserts on tabletops
- ◆ Satin finish stainless steel
- ◆ Fits 3-3/4" diameter wine bottles

ITEM	DESCRIPTION	SIZE	UOM	CASE
DWCC-5	Smooth Finish	4-5/8" Dia x 2-5/8"H	Each	12
DWCC-5H	Hammered Finish	4-5/8" Dia x 2-5/8"H	Each	12



### WINE COOLERS

ITEM	DESCRIPTION	SIZE	COLOR	UOM	CASE
WC-60	Double Wall Hourglass, Mirror S/S	6" Dia x 7" H		Each	12
WC-7M	Marble	4 1/2" Dia x 7" H	White	Each	6
WC-5	Double Wall, Satin S/S, No Retail Pkg.	4 1/2" Dia x 7-3/4" H		Each	6/24
WC-4A	Acrylic	4 1/2" Dia x 9 1/4" H	Clear	Each	12



## NON-SLIP SERVING TRAYS



TFG-16N

TFG-2622K

**NSF** TFG-SERIES



## DELUXE FIBERGLASS TRAYS

- ◆ High durability fiberglass tray with self-molded peel-resistant non-slip surface
- ◆ Easy to wash by hand, however not recommended to leave soaking in hot water
- ◆ NSF listed

ITEM	DESCRIPTION	SIZE	COLOR	UOM	CASE
TFG-11K	Round	11"	Black	Each	12
TFG-11N	Round	11"	Brown	Each	12
TFG-14K	Round	14"	Black	Each	12
TFG-14N	Round	14"	Brown	Each	12
TFG-16K	Round	16"	Black	Each	12
TFG-16N	Round	16"	Brown	Each	12
TFG-2622K	Oval	26"x 22"	Black	Each	6
TFG-2622N	Oval	26"x 22"	Brown	Each	6



TRH-16

TRH-2722K

**NSF** TRH-SERIES

## EASY-HOLD RUBBER-LINED PLASTIC TRAYS

- ◆ NSF listed

ITEM	DESCRIPTION	SIZE	COLOR	UOM	CASE
TRH-11	Round	11"	Brown	Each	12
TRH-11K	Round	11"	Black	Each	12
TRH-14	Round	14"	Brown	Each	12
TRH-14K	Round	14"	Black	Each	12
TRH-16	Round	16"	Brown	Each	12
TRH-16K	Round	16"	Black	Each	12
TRH-1418	Rectangular	14"x 18"	Brown	Each	12
TRH-1418K	Rectangular	14"x 18"	Black	Each	12
TRH-2722	Oval	22"x 27"	Brown	Each	6
TRH-2722K	Oval	22"x 27"	Black	Each	6



TCK-16

## PLASTIC CORK-LINED TRAYS

ITEM	DESCRIPTION	SIZE	UOM	CASE
TCK-14	Round	14"	Each	12/48
TCK-16	Round	16"	Each	12/36
TCK-14CK	Replacement Cork for TCK-14		Each	50/350
TCK-16CK	Replacement Cork for TCK-16		Each	50/350

## TRAY STANDS



TSY-1A

TR-33W

TR-34W

## TRAY STANDS

ITEM	DESCRIPTION	SIZE	UOM	CASE
TSY-1A	Chrome Steel	31"	Each	6
TR-33W	Rubberwood, Walnut	32"	Each	1
TR-34W	Rubberwood, Mahogany	32"	Each	1



### SERVING TRAYS

Made of highly polished stainless steel, these round trays feature a whimsical swirl design, adding a modern flair to even the most traditional drink presentations.

ITEM	DESCRIPTION	SIZE	UOM	CASE
STRS-12	Round	12"	Each	12/48
STRS-14	Round	14"	Each	12/24
STRS-16	Round	16"	Each	12/24

### SERVING TRAYS



STRS-14

### CHROME SERVING TRAYS

The classic gadroon edge and traditional engraving of these chrome-plated trays are perfect for tea and coffee service, as well as pastries, appetizers and desserts.

- ◆ Available in a variety of shapes and sizes
- ◆ Not recommended for prolonged use with meat or acidic ingredients
- ◆ Hand wash only

ITEM	DESCRIPTION	SIZE	UOM	CASE
CMT-1912	Rectangular w/Handles	19-1/2" x 12-1/2"	Each	12/24
CMT-1217	Octagonal	17" x 12-1/2"	Each	12/24
CMT-1420	Octagonal	20" x 14"	Each	12/24
CMT-1812	Rectangular	18" x 12-1/2"	Each	12/24
CMT-2014	Rectangular	20" x 14"	Each	12/24
CMT-1014	Oval	14-3/4" x 10-1/2"	Each	12/24
CMT-1318	Oval	18-3/4" x 13"	Each	12/24
CMT-14	Round	14"	Each	12/24

### CHROME SERVING TRAYS



CMT-1912



CMT-1420



CMT-2014



CMT-14



CMT-1318

### PLATTERS

- ◆ Stainless steel

ITEM	DESCRIPTION	SIZE	UOM	CASE
OPL-12	Oval	11-3/4" x 7-7/8"	Each	10/60
OPL-14	Oval	13-5/8" x 9-1/2"	Each	10/60
OPL-16	Oval	15-7/8" x 10-1/2"	Each	10/40
OPL-18	Oval	17-7/8" x 12-1/4"	Each	10/30
OPL-20	Oval	19-5/8" x 13-1/2"	Each	10/20
OPL-22	Oval	21-5/8" x 15"	Each	12

### OVAL PLATTERS



OPL-14

## DINING TRAYS



Reinforced bottom



**3** POPULAR SIZES  
**7** GREAT COLORS



**NSF** **BPA FREE** FFT-SERIES



FTNS-1216B

**NSF** **BPA FREE** FTNS-SERIES



**NSF** FGT-SERIES



Reinforced to prevent warping

Available tray colors:

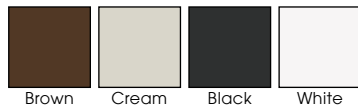

**MOLDED-IN LUGS ALLOW FOR QUICK DRYING**



**NSF** FGTT-SERIES

## HIGH QUALITY PLASTIC CAFETERIA TRAYS

- ◆ Resists warping with frequent use
- ◆ NSF listed

ITEM	DESCRIPTION	COLOR	UOM	CASE
FFT-1014B	10" x 14"	Brown	Each	12/48
FFT-1014E	10" x 14"	Grey	Each	12/48
FFT-1014G	10" x 14"	Green	Each	12/48
FFT-1014K	10" x 14"	Black	Each	12/48
FFT-1014O	10" x 14"	Orange	Each	12/48
FFT-1014R	10" x 14"	Red	Each	12/48
FFT-1014U	10" x 14"	Burgundy	Each	12/48
FFT-1216B	12" x 16"	Brown	Each	12/48
FFT-1216E	12" x 16"	Grey	Each	12/48
FFT-1216G	12" x 16"	Green	Each	12/48
FFT-1216K	12" x 16"	Black	Each	12/48
FFT-1216O	12" x 16"	Orange	Each	12/48
FFT-1216R	12" x 16"	Red	Each	12/48
FFT-1216U	12" x 16"	Burgundy	Each	12/48
FFT-1418B	14" x 18"	Brown	Each	12/48
FFT-1418E	14" x 18"	Grey	Each	12/48
FFT-1418G	14" x 18"	Green	Each	12/48
FFT-1418K	14" x 18"	Black	Each	12/48
FFT-1418O	14" x 18"	Orange	Each	12/48
FFT-1418R	14" x 18"	Red	Each	12/48
FFT-1418U	14" x 18"	Burgundy	Each	12/48

## NON-SLIP CAFETERIA TRAYS

*With a non-skid coating surface that helps to reduce messy spills, these are the best dining trays available for busy cafeterias, restaurants and bars.*

- ◆ Bowls, glassware, plates and utensils do not slip, even when tray is tilted at a 30° angle
- ◆ Dishwasher safe
- ◆ NSF listed

ITEM	DESCRIPTION	COLOR	UOM	CASE
FTNS-1216B	12" x 16"	Brown	Each	12/48
FTNS-1216K	12" x 16"	Black	Each	12/48
FTNS-1418B	14" x 18"	Brown	Each	12/48
FTNS-1418K	14" x 18"	Black	Each	12/48

## FIBERGLASS RECTANGULAR DINING TRAYS

- ◆ Multi-purpose rectangular trays are perfect for any setting
- ◆ Long-lasting heavy-weight trays last through years of high-traffic use
- ◆ NSF listed

ITEM	DESCRIPTION	COLOR	UOM	CASE
FGT-1216B	12" x 16	Brown	Each	12
FGT-1216C	12" x 16	Cream	Each	12
FGT-1216K	12" x 16	Black	Each	12
FGT-1418B	14" x 18"	Brown	Each	12
FGT-1418C	14" x 18"	Cream	Each	12
FGT-1418K	14" x 18"	Black	Each	12
FGT-1418W	14" x 18"	White	Each	12
FGT-1520B	15" x 20"	Brown	Each	12

## FIBERGLASS TRAPEZOID DINING TRAYS

- ◆ Trapezoid trays are ideal for tabletops with limited space
- ◆ Long-lasting heavy-weight trays last through years of high-traffic use
- ◆ NSF listed

ITEM	DESCRIPTION	COLOR	UOM	CASE
FGTT-1814B	18" x 14"	Brown	Each	12
FGTT-1814C	18" x 14"	Cream	Each	12
FGTT-1814K	18" x 14"	Black	Each	12
FGTT-1814W	18" x 14"	White	Each	12

## ALUMINUM SERVING TRAYS

Winco's aluminum sheet pans are not only a baker's default tool for all functions, but are also ideal as serving trays to complement any rustic table setting.

- ◆ Closed bead with galvanized wire for rust resistance and reinforcement (1/4 and 1/2 size)
- ◆ Made of 3003 aluminum

ITEM	DESCRIPTION	SIZE	GAUGE	UOM	CASE
ALXP-0609	6" x 9"	1/8-Size	16	Each	24
ALXP-1013	9-1/2" x 13"	1/4-Size	20	Each	24
ALXP-1318	13" x 18"	1/2-Size	20	Each	12

SEE PAGE 160 FOR MORE SHEET PANS



ALXP-0609

## 6 COMPARTMENT MESS TRAYS

- ◆ Stainless steel mirror finish and dishwasher safe

ITEM	DESCRIPTION	UOM	CASE
SMT-1	15-1/2" x 11-1/2"	Each	24
SMT-2	15-1/2" x 11-1/2"	Each	24



SMT-1



SMT-2

## PLASTIC OVAL PLATTERS

- ◆ Sturdy BPA-free poly plastic
- ◆ Great for bread, appetizers, sandwiches and fries
- ◆ Dishwasher safe

ITEM	DESCRIPTION	COLOR	UOM	CASE
PLB-G	10-3/4" x 7-1/4" x 1-1/2"	Green	Doz	12
PLB-K	10-3/4" x 7-1/4" x 1-1/2"	Black	Doz	12
PLB-R	10-3/4" x 7-1/4" x 1-1/2"	Red	Doz	12
PLB-Y	10-3/4" x 7-1/4" x 1-1/2"	Yellow	Doz	12

## FAST FOOD BASKETS



PLB-SERIES

BPA FREE

## PREMIUM PLASTIC OVAL BASKETS

- ◆ Sturdy BPA-free poly plastic
- ◆ Great for fast dining establishments
- ◆ Choice of five different colors
- ◆ Dishwasher safe

ITEM	DESCRIPTION	COLOR	UOM	CASE
POB-G	10-1/4" x 6-3/4" x 2"	Green	Doz	12
POB-K	10-1/4" x 6-3/4" x 2"	Black	Doz	12
POB-R	10-1/4" x 6-3/4" x 2"	Red	Doz	12
POB-Y	10-1/4" x 6-3/4" x 2"	Yellow	Doz	12
PFB-10B	9-1/2" x 5" x 2"	Brown	Doz	3
PFB-10G	9-1/2" x 5" x 2"	Green	Doz	3
PFB-10R	9-1/2" x 5" x 2"	Red	Doz	3



POB-SERIES

BPA FREE



PFB-SERIES

BPA FREE

## CONDIMENT DISPENSER



PKTS-2D

## CONDIMENT DISPENSER

Ideal for busy bars, food stands, convenience stores or fast-food service. Removable plastic inserts allow for easy cleaning.

- ◆ Durable 18/8 stainless steel, heavy duty pump
- ◆ Two (2) plastic inserts with 2 quart capacity
- ◆ Each pump full stroke draws out between 1 oz and 1-1/4 oz depending on viscosity
- ◆ Overall dimensions: 11"L x 8-3/4"W x 16"H (with pump)
- ◆ Assembly required

ITEM	DESCRIPTION	UOM	CASE
PKTS-2D	Condiment Dispenser with 2 Standard Pumps	Set	2
PKTS-PT01	Individual Pump with Lid	Each	1
PKTS-PT02	Replacement Plastic Jar	Each	1
PKTS-PT03	Stainless Steel Casing	Each	1

## SQUEEZE BOTTLES



Wide-mouth squeeze bottle

PSW-24

BPA FREE

PSW-SERIES

6 per pack

- ◆ Open tip, no need for cutting
- ◆ Each pack contains six (6) pieces
- ◆ BPA-free

## WIDE-MOUTH SQUEEZE BOTTLES

ITEM	DESCRIPTION	COLOR	UOM	CASE
PSW-12	12 Oz	Clear	Pack	12
PSW-12R	12 Oz	Red	Pack	12
PSW-12Y	12 Oz	Yellow	Pack	12
PSW-16	16 Oz	Clear	Pack	8
PSW-16R	16 Oz	Red	Pack	8
PSW-16Y	16 Oz	Yellow	Pack	8
PSW-24	24 Oz	Clear	Pack	8
PSW-24R	24 Oz	Red	Pack	8
PSW-24Y	24 Oz	Yellow	Pack	8
PSW-32	32 Oz	Clear	Pack	6
PSW-32R	32 Oz	Red	Pack	6
PSW-32Y	32 Oz	Yellow	Pack	6

## REGULAR SQUEEZE BOTTLES

ITEM	DESCRIPTION	COLOR	UOM	CASE
PSB-08C	8 Oz	Clear	Pack	12
PSB-08R	8 Oz	Red	Pack	12
PSB-08Y	8 Oz	Yellow	Pack	12
PSB-12C	12 Oz	Clear	Pack	12
PSB-12R	12 Oz	Red	Pack	12
PSB-12Y	12 Oz	Yellow	Pack	12
PSB-24C	24 Oz	Clear	Pack	6
PSB-24R	24 Oz	Red	Pack	6
PSB-24Y	24 Oz	Yellow	Pack	6

## DECORATIVE PICKS



PK-P4

PK-C2

PK-C4

PK-A35

PK-S3

## DECORATIVE PICKS

- ◆ Available in a variety of styles and colors
- ◆ Easily displayed with hang-card packaging

ITEM	DESCRIPTION	SIZE	PCS/BAG	UOM	CASE
PK-P4	Parasol	3-15/16"	144	Bag	100
PK-C2	Cellophane Frills	2-9/16"	1,000	Bag	10
PK-C4	Cellophane Frills	3-15/16"	1,000	Bag	10
PK-A35	Plastic Arrow	3-7/16"	500	Bag	20
PK-S3	Plastic Sword	2-3/4"	500	Bag	20

**STAINLESS STEEL ROTARY CHEESE GRATER**

- ◆ 18/8 stainless steel rotary grater with one drum for grating fine cheeses

ITEM	DESCRIPTION	UOM	CASE
GRTS-1	8-1/4"L x 4-3/4"W x 3-3/8"H	Each	12/36

**PLASTIC ROTARY CHEESE GRATER**

- ◆ Ideal for grating hard cheese or chocolate
- ◆ Includes 2 interchangeable drums for fine and coarse grating
- ◆ Dishwasher safe

ITEM	DESCRIPTION	UOM	CASE
PRTS-2	7"L x 3-1/2"W x 4"H	Each	6/24

**ZESTER GRATERS**

- ◆ Etched 18/8 stainless steel blade
- ◆ Comes with cover for the blade
- ◆ Comfortable soft-grip handle
- ◆ Superior anti-corrosion properties and durability

ITEM	DESCRIPTION	UOM	CASE
GT-103	Medium Coarse Blade	Each	12/72
GT-104	Zester Blade	Each	12/72
GT-105	Fine Blade	Each	12/72
GT-106	Ribbon Blade	Each	12/72

**CHEESE KNIFE SETS**

*Whether it's for a wine tasting event or to accompany dessert, present and serve a full range of cheeses elegantly with these 6-piece cheese knife sets.*

- ◆ Each set includes 6 knives for hard, soft, firm or crumbly cheeses
- ◆ Stainless steel blades

ITEM	DESCRIPTION	UOM	CASE
KCS-6	6-Pc Set w/POM Hdls	Set	48
KCS-6W	6-Pc Set w/Wooden Hdls	Set	48



**WOOD BREAD/CHEESE BOARD**

ITEM	DESCRIPTION	UOM	CASE
WCB-125	12" x 5" x 3/4"	Each	24

**TABLESIDE SERVICE**

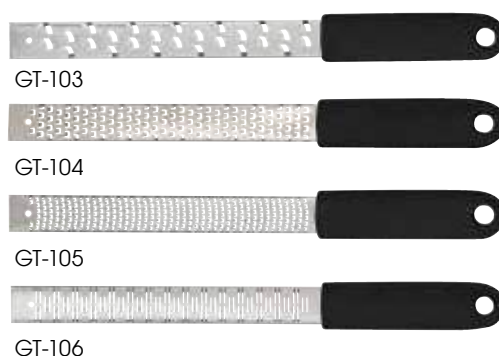

## SEAFOOD SERVICE



ASFT-12



SFR-4



## SEAFOOD TRAYS

Create an enticing tabletop spread with these trays in assorted sizes for displaying seafood or appetizers. The brushed aluminum construction retains cold and keeps foods at safe serving temperatures.

ITEM	DESCRIPTION	UOM	CASE
ASFT-12	12"Dia x 1-1/2"H	Each	12/36
ASFT-14	13-3/4"Dia x 1-1/2"H	Each	12/36
ASFT-16	15-3/4"Dia x 1-1/2"H	Each	12/24
ASFT-18	17-3/4"Dia x 1-1/2"H	Each	12/24
ASFT-20	19-3/4"Dia x 1-1/2"H	Each	12



### CHROME-PLATED SEAFOOD TRAY RACKS

- ◆ Use with ASFT-series seafood trays to create appealing tabletop presentations
- ◆ Also perfect for elevating serving plates, bowls and platters, as well as holding pizza pans

ITEM	DESCRIPTION	UOM	CASE
SFR-4	7-3/8" Top Dia / 9-5/8" Bottom Dia x 4-3/8"H	Each	20
SFR-7	7-3/8" Top Dia / 9-5/8" Bottom Dia x 7"H	Each	20

## LOBSTER CRACKERS

ITEM	DESCRIPTION	SIZE	UOM	CASE
LC-01	Stainless Steel	6"	Each	12/72
LC-03	Chrome Plated, Large	6"	Each	12/144
LC-04	Nut/Lobster Cracker	4-3/4"	Each	24/144
LC-05	Zinc Alloy	6"	Each	12/72
LC-85	Zinc Alloy, Carded	6"	Each	12/72



LC-85



LC-01



LC-03



LC-04

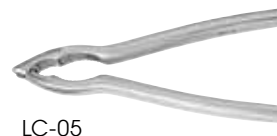

LC-05



### SEAFOOD PICKS

- ◆ 18/8 stainless steel with decorative lobster stamp
- ◆ Narrow two-tine fork designed to effortlessly extract more shellfish meat

ITEM	DESCRIPTION	UOM	CASE
LC-08	8"L x 3/4"W, 4-Pcs/Pk	Pack	30/120



LC-08



SBW-35

### BUTTER WARMER

- ◆ Set includes stand, butter cup, candle holder and candle

ITEM	DESCRIPTION	UOM	CASE
SBW-35	4-Pc Set	Set	48



SND-6



SND-T6



SND-F7

### SNAIL SERVICE

- ◆ Stainless steel

ITEM	DESCRIPTION	UOM	CASE
SND-6	Dish, 6-Holes	Each	12/144
SND-T6	Tongs	Each	12/120
SND-F7	Fork	Doz	50

### RESERVED SIGN

- ◆ Stainless steel

ITEM	DESCRIPTION	UOM	CASE
RVS-4	4-3/4" x 1-3/4", S/S	Each	12/120

### RESERVED SIGN



RVS-4

### TABLE CRUMBERS

- ◆ Aluminum
- ◆ Features a pocket clip

ITEM	DESCRIPTION	UOM	CASE
ATC-16G	6", Gold	Each	120/600
ATC-16S	6", Silver	Each	120/600

### TABLE CRUMBERS



ATC-16G



ATC-16S

### CALL BELLS

- ◆ Chrome plated with plastic base

ITEM	DESCRIPTION	UOM	CASE
CBEL-1	3-1/2"Dia	Each	12/144
CBEL-2	4"Dia	Each	12/72

### CALL BELLS



CBEL-1



CBEL-2

### ORDER RACKS

- ◆ Aluminum
- ◆ New style takes up less space to mount, easily fits onto narrow counter edges

ITEM	DESCRIPTION	UOM	CASE
ODR-18N	18"	Each	12/24
ODR-24N*	24"	Each	12/24
ODR-36N*	36"	Each	12/24
ODR-48N*	48"	Each	12/24

### ORDER RACKS



ODR-24N

### GUEST ORDER/CHECK HOLDERS

- ◆ Classic check holder has a grooved spine to hold a pen
- ◆ Folding-style prevents contents from falling out
- ◆ Slots for credit card and check

ITEM	DESCRIPTION	UOM	CASE
CHK-1K	10" x 5-1/2"	Each	12/96
CHK-2K	5-1/4" x 8-1/2" w/Elastic Pen Loop	Each	12/96

### CHECK SERVICE



CHK-2K



CHK-1K



### TIP TRAY

ITEM	DESCRIPTION	UOM	CASE
TT-46	4-1/2" x 6-1/2"	Doz	12



TT-46

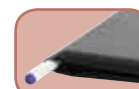

CHK-1K closes flat with pen inside

### CHECK SPINDLE

ITEM	DESCRIPTION	UOM	CASE
CS-1	6" H, Steel Wire	Each	12/240



CS-1

### CHECK CADDY

ITEM	DESCRIPTION	UOM	CASE
CS-3	3"Dia, Brass-Plated	Each	12/36



CS-3

### COUNTERFEIT DETECTION PEN

- ◆ Fast and easy way to detect fraudulent bills
- ◆ Great for the busy retail or restaurant environment
- ◆ Can be used with other counterfeit detection methods
- ◆ Each pack contains two (2) pieces

ITEM	DESCRIPTION	UOM	CASE
PPM-2	2-Pcs/Pk	Pack	18/72



PPM-2



## MINI WASTE CAN

**NEW**



DDSF-101S

AVAILABLE IN  
MAY 2017



## STAINLESS STEEL MINI SWING LID WASTE CAN

ITEM	DESCRIPTION	UOM	CASE
DDSF-101S	4-3/4"Dia x 6"H	Each	12/48

## TABLETOP DISPENSERS



**BPA  
FREE**

ACSD-712



**BPA  
FREE**

ACTD-3

## ACRYLIC STRAW DISPENSER

◆ BPA-free

ITEM	DESCRIPTION	UOM	CASE
ACSD-712	10-3/4" x 4-3/4" x 7"	Each	6



## ACRYLIC TOOTHPICK DISPENSER

◆ BPA-free

ITEM	DESCRIPTION	UOM	CASE
ACTD-3	3" x 2-1/2" x 4"	Each	6/36



## PLASTIC VERTICAL STRAW DISPENSER

- ◆ Break-resistant polycarbonate holder with stainless steel pull-up dispenser feature
- ◆ Capacity 100 straws

ITEM	DESCRIPTION	UOM	CASE
SDP-3	3-3/8"Dia x 10-3/4"H	Each	12



SDP-3



## NAPKIN DISPENSERS

◆ Stainless steel

ITEM	DESCRIPTION	UOM	CASE
NH-5	3-1/2"W x 5"H	Each	36
NH-7	3-1/2"W x 7"H	Each	36



NH-5



NH-7



### STAINLESS STEEL ASHTRAY

ITEM	DESCRIPTION	UOM	CASE
SAS-4	4"Dia, Stackable	Each	24/96

### ASHTRAYS



SAS-4



MAS-4K



MAS-4R



### BAKELITE ASHTRAYS

- ◆ Heat resistant up to 380°F (193°C)

ITEM	DESCRIPTION	COLOR	UOM	CASE
MAS-4K	4"Dia	Black	Doz	12
MAS-4R	4"Dia	Red	Doz	12



### RECHARGEABLE TEALIGHTS

- ◆ A complete charge provides 12 hours of simulated flickering light
- ◆ Each tealight has an on/off switch on the bottom
- ◆ Includes linkable base, adapter and NiMH battery

ITEM	DESCRIPTION	SIZE	UOM	CASE
CLR-6S	6-Pcs/Pk	5-7/8"L x 3-7/8"W x 3-13/16"H	Set	20
CLR-12S	12-Pcs/Pk	11-1/4"L x 3-7/8"W x 4-3/4"H	Set	12

### RECHARGEABLE TEALIGHTS



CL-L

CLR-12S

### REPLACEMENT TEALIGHT

- ◆ Uses 1 CR2032 battery (included)
- ◆ Lasts over 60 hours

ITEM	DESCRIPTION	UOM	CASE
CL-L	1-1/2"Dia x 1-1/2"H	Each	12/240



### STABLEIZER TABLE WEDGES/SHIMS

*sTABLEize the customer's most common complaint of wobbly tables with these economical and practical plastic wedges!*

- ◆ sTABLEize wobbly tables
- ◆ sTABLEize shelves
- ◆ Install commercial glass doors and much more!
- ◆ Each pack contains 75 pieces

ITEM	DESCRIPTION	UOM	CASE
TW-75B	Black, Flexible	Pack	48
TW-75W	Translucent, Hard	Pack	48

### TABLE WEDGES

**STABLEizer**  
Installation Shims



75 pcs per container



TW-75B



TW-75W



## TABLE COVERS & CLIPS

**NEW COLOR**

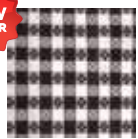

TBCS-52R

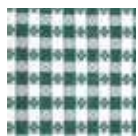

Available Colors  
TBCS & TBCO-SERIES



TBC-1

**FITS UP TO  
1-1/2" THICK  
TABLES**



Clip holds table cloth in place



### TABLE COVERS

◆ Plastic checkered pattern with cotton lining

ITEM	DESCRIPTION	COLOR	UOM	CASE
TBCS-52B	52" x 52" Square	Blue	Each	24
TBCS-52G	52" x 52" Square	Green	Each	24
TBCS-52R	52" x 52" Square	Red	Each	24
TBCS-52K	52" x 52" Square	Black	Each	24
TBCO-70B	52" x 70" Rectangle	Blue	Each	24
TBCO-70G	52" x 70" Rectangle	Green	Each	24
TBCO-70R	52" x 70" Rectangle	Red	Each	24
TBCO-70K	52" x 70" Rectangle	Black	Each	24
TBCO-90B	52" x 90" Rectangle	Blue	Each	24
TBCO-90G	52" x 90" Rectangle	Green	Each	24
TBCO-90R	52" x 90" Rectangle	Red	Each	24
TBCO-90K	52" x 90" Rectangle	Black	Each	24



### TABLE CLOTH CLIP

◆ Perfect for outdoor events

ITEM	DESCRIPTION	UOM	CASE
TBC-1	Stainless steel	Doz	6/60

## SERVICE & COAT CHECK



GLC-M



WA-3129K



### WHITE COTTON SERVICE GLOVES

ITEM	DESCRIPTION	COLOR	UOM	CASE
GLC-M	Medium (6 pairs)	White	Doz	100
GLC-L	Large (6 pairs)	White	Doz	100



### BISTRO-LENGTH APRON

◆ Cotton/poly blend, machine wash & dry, wrinkle resistant

ITEM	DESCRIPTION	COLOR	UOM	CASE
WA-3129K	31" x 29-1/2"	Black	Each	12/60



WA-SERIES



### 3-POCKET WAIST APRONS

◆ Cotton/poly blend, machine wash & dry, wrinkle resistant

ITEM	DESCRIPTION	COLOR	UOM	CASE
WA-1221	12-1/2" x 21-3/4"	Black	Each	12/60
WA-1221G	12-1/2" x 21-3/4"	Green	Each	12/60
WA-1221R	12-1/2" x 21-3/4"	Burgundy	Each	12/60
WA-1221W	12-1/2" x 21-3/4"	White	Each	12/60



### COAT HANGERS

ITEM	DESCRIPTION	UOM	CASE
WCH-1	Wooden	Doz	10



WCH-1



CCK-5BL



CCK-5PK



CCK-5WT



CCK-5YL

### COAT CHECK TICKETS

◆ Each box contains 500 pieces

ITEM	DESCRIPTION	UOM	CASE
CCK-5BL	Blue Tickets	Box	20
CCK-5PK	Pink Tickets	Box	20
CCK-5WT	White Tickets	Box	20
CCK-5YL	Yellow Tickets	Box	20

### DELIVERY BAGS

- ◆ Outer shell/liner: polyester; Filling: EPE
- ◆ Heat retention: 2 hours @ 167°F; 4 hours @ 131°F; 6 hours @ 95°F

ITEM	DESCRIPTION	UOM	CASE
BGDV-12	12" x 12" x 12"	Each	6
BGDV-22	22" x 22" x 12"	Each	6

### PIZZA BAGS

- ◆ Outer shell/liner: polyester; Filling: EPE
- ◆ Insulated lining keeps food warm for longer periods of time

ITEM	DESCRIPTION	UOM	CASE
BGPZ-18	18" x 18" x 5"	Each	6
BGPZ-20	20" x 20" x 5"	Each	6
BGPZ-24	24" x 24" x 5"	Each	6

### DELIVERY BAGS



### FLATWARE CYLINDERS & HOLDERS

ITEM	DESCRIPTION	UOM	CASE
FC-PL	Perforated, Plastic	Each	36/144
FC-SS	Perforated, S/S	Each	20/80
FC-SL	Solid, S/S	Each	20/80
FC-4H	4-Holes/2-Tier Holder, S/S	Each	4
FC-6H	6-Holes/2-Tier Holder, S/S	Each	2

### CUTLERY COMPARTMENT BINS

ITEM	DESCRIPTION	UOM	CASE
PL-4B	Plastic	Each	12
SCB-4	Stainless Steel	Each	8

### CUTLERY ORGANIZERS

ITEM	DESCRIPTION	UOM	CASE
OGZ-6	Organizer Bin Set	Set	1
OGZ-1B	Bin for OGZ-6	Each	6

### CUTLERY DISHWASHER BASKET

- ◆ Built-in handles
- ◆ NSF listed

ITEM	DESCRIPTION	SIZE	UOM	CASE
PCB-8	8 Compartments	17" x 8" x 6"	Each	12

### FLATWARE ORGANIZERS



### MULTI-SURFACE SWEEPER

- ◆ Non-electric rotary sweeper with natural bristles and steel handle

ITEM	DESCRIPTION	UOM	CASE
FSW-11	11"L x 7-3/4"W x 43"H	Each	4

### LOBBY PAN

- ◆ Built-in cover for mess-free transport

ITEM	DESCRIPTION	UOM	CASE
DP-13C	13"	Set	10

### ANGLED BROOM

- ◆ Made of plastic bristles

ITEM	DESCRIPTION	UOM	CASE
BRM-60L	60"	Each	12

### DINING ROOM MAINTENANCE



## HIGH CHAIRS & BOOSTERS



CHH-101A



CHH-103A



CHH-104A



CHH-601

**NEW**

AVAILABLE IN  
MAY 2017



CHH-25



CHB-701



CHB-703



CHB-704



CHB-2PK



CHB-2P

### STACKING HIGH-CHAIRS

- ◆ High-quality rubberwood
- ◆ Buckle strap restrains child around the waist
- ◆ Assembled size: 20-1/8"W x 19-3/8"D x 29-1/4"H, seat at 20"H

ITEM	DESCRIPTION	UOM	CASE
CHH-101	Natural, Knocked Down	Each	1
CHH-101A	Natural, Assembled	Each	1
CHH-103	Mahogany, Knocked Down	Each	1
CHH-103A	Mahogany, Assembled	Each	1
CHH-104	Walnut, Knocked Down	Each	1
CHH-104A	Walnut, Assembled	Each	1
CHH-3	High-Chair Strap, 2-Pc Seat Belt, 1-Pc Center Strap	Set	12/240



CHH-3

### WOODEN PUB-HEIGHT HIGH CHAIR

- ◆ Assembled size: 19"W x 20"D x 41"H, seat at 32"H

ITEM	DESCRIPTION	UOM	CASE
CHH-601	Natural, Knocked Down	Each	1

### STACKABLE PLASTIC HIGH CHAIR

- ◆ Sturdy and durable polypropylene construction
- ◆ Plastic surface wipes clean after each use
- ◆ Snap-on tray included
- ◆ Assembly required
- ◆ Assembled size: 25-1/2"W x 23"D x 29-1/2"H
- ◆ Stackable with tray removed

ITEM	DESCRIPTION	UOM	CASE
CHH-25	High Chair w/Tray, Plastic	Set	1

### STACKING BOOSTER SEATS

- ◆ High-quality rubberwood
- ◆ Buckle strap restrains child around the waist
- ◆ Additional strap used for securing the booster to the chair
- ◆ Size: 11-3/4"W x 11-3/4"D x 10-1/2"H

ITEM	DESCRIPTION	UOM	CASE
CHB-701	Natural	Each	1
CHB-703	Mahogany	Each	1
CHB-704	Walnut	Each	1

### DOUBLE-SIDED BOOSTER SEATS

- ◆ Features include contoured seat, high sides, wide square base and non-skid surface
- ◆ Durable polyethylene will never dent, chip, rust or break
- ◆ Buckle strap restrains child around the waist with additional strap used for securing the booster to the chair
- ◆ Dishwasher safe
- ◆ Size: 12"W x 11-7/8"D x 9-1/4"H

ITEM	DESCRIPTION	UOM	CASE
CHB-2PK	Black	Each	1
CHB-2P	Brown	Each	1

### "OPEN" LED SIGNS

- ◆ UL listed adaptor

ITEM	DESCRIPTION	UOM	CASE
LED-6	Rectangle, 1 Flashing Pattern	Each	5
LED-10	Oval, 3 Flashing Patterns	Each	5

## LED SIGNS



LED-10



LED-6



LED-11

LED-SERIES 

### "PIZZA" LED SIGN

- ◆ Dust proof cover
- ◆ UL listed adaptor

ITEM	DESCRIPTION	UOM	CASE
LED-11	Oval, 3 Flashing Patterns	Each	5

### STANCHION SYSTEMS

- ◆ Heavy base stand with 36" post and 6-1/2' retractable belt
- ◆ Stanchions must be purchased in multiples of two (2)

ITEM	DESCRIPTION	UOM	CASE
CGS-38K	Black Stanchion	Each	2
CGS-38S	Stainless Steel Stanchion	Each	2
CGS-WB	Wall Bracket for CGS-38K/S	Each	100
CGS-K	Black Belt for CGS-38K/S	Each	12/48
CGSF-12K	Black Frame for CGS-38K	Each	4
CGSF-12S	Stainless Steel Frame for CGS-38S	Each	4

### STANCHION SIGN SYSTEMS



CGSF-12K



CGSF-12S

CGS-38K

CGS-38S

### STANCHION FRAME SIGNS

ITEM	DESCRIPTION	UOM	CASE
SGN-801	Please Enter Here	Each	6/36
SGN-802	Please Wait To Be Seated	Each	6/36
SGN-803	Line Forms Here	Each	6/36
SGN-804	Sorry Section Closed	Each	6/36
SGN-805	Exit	Each	6/36



SGN-800 SERIES

### HOSTESS SIGN

- ◆ 60" tall sign stand with interchangeable messages
- ◆ Includes 15 message signs, a stand and base
- ◆ Easy to assemble

ITEM	DESCRIPTION	UOM	CASE
HTS-60K	Hostess Sign	Set	4

### HOSTESS SIGN



HTS-60K

## INFORMATION SIGNS



SGN-SERIES  
3" X 9"



SGN-SERIES  
6" X 9"

### BRAILLE



SGNB-SERIES  
6" X 9"

Our information/way-finding signs are available in 9" x 3" and 6" x 9" sizes with universal symbols and clear letters on anti-glare surfaces.



### 9"W X 3"H INFORMATION SIGNS

ITEM	DESCRIPTION	COLOR	UOM	CASE
SGN-301	Push	Black	Each	12/144
SGN-302	Pull	Black	Each	12/144
SGN-303	Hand Wash Only	Black	Each	12/144
SGN-304	Private	Black	Each	12/144
SGN-305	Employees Only	Black	Each	12/144
SGN-310	No Smoking	Black	Each	12/144
SGN-311	Men	Black	Each	12/144
SGN-312	Women	Black	Each	12/144
SGN-313	Restrooms	Black	Each	12/144
SGN-317	Restroom for Customer Use Only	Black	Each	12/144
SGN-318	Wash	Black	Each	12/144
SGN-322	Employees Must Wash Hands Before Returning to Work	Black	Each	12/144
SGN-325	Telephone	Black	Each	12/144
SGN-326	Caution/Watch Your Step	Black	Each	12/144
SGN-327	Rinse	Black	Each	12/144
SGN-328	Reserved	Black	Each	12/144
SGN-329	Sanitize	Black	Each	12/144
SGN-330	WiFi	Black	Each	12/144
SGN-331	No Admittance	Black	Each	12/144
SGN-332	No Pets/Shoes Shirt Required	Black	Each	12/144
SGN-333	No Food or Drink	Black	Each	12/144
SGN-334	No Cell Phone Use, Please	Black	Each	12/144
SGN-335	No E-Cigarettes	Black	Each	12/144
SGN-381W	Exit	White	Each	12/144
SGN-382W	Fire Extinguisher	White	Each	12/144



### 6"W X 9"H INFORMATION SIGNS

ITEM	DESCRIPTION	COLOR	UOM	CASE
SGN-601	No Smoking	Black	Each	12/72
SGN-603	Restrooms	Black	Each	12/72
SGN-651B	Women	Blue	Each	12/72
SGN-652B	Men	Blue	Each	12/72
SGN-653B	Accessible	Blue	Each	12/72
SGN-681W	Exit	White	Each	12/72
SGN-682W	Fire Extinguisher	White	Each	12/72
SGN-683W	In Case of Fire Do Not Use Elevator...	White	Each	12/72
SGN-684W	No Smoking Area	White	Each	12/72



### 6"W X 9"H INFORMATION SIGNS WITH BRAILLE

ITEM	DESCRIPTION	COLOR	UOM	CASE
SGNB-601	No Smoking	Black	Each	12/72
SGNB-603	Restrooms	Black	Each	12/72
SGNB-604	Exit	Black	Each	12/72
SGNB-605	Men	Black	Each	12/72
SGNB-606	Women	Black	Each	12/72
SGNB-651B	Women/Accessible	Blue	Each	12/72
SGNB-652B	Men/Accessible	Blue	Each	12/72
SGNB-653B	Accessible	Blue	Each	12/72

## DISPLAY SIGNAGE BOARDS & ACCESSORIES

- ◆ Perfect for bakeries, cafes, coffee shops, pubs and restaurants
- ◆ Made for frequently changing specials, the High-tech Absol-Flat black glossy surface allows for clean and mess-free writing
- ◆ Solid 1-1/4" wide frame with double reinforced joints
- ◆ Durable packaging prevents damage while in transit



### WOODEN FRAME MARKER BOARDS

ITEM #	DESCRIPTION	INCLUDES	SIZE	UOM	CASE
MBB-1	Natural	1 Standard White Marker & Eraser	23-5/8"L x 3/4"W x 31-5/8"H	Set	6
MBB-3	Mahogany	1 Standard White Marker & Eraser	23-5/8"L x 3/4"W x 31-5/8"H	Set	6

### DUAL-SIDED SIDEWALK A-FRAME MARKER BOARDS

ITEM #	DESCRIPTION	INCLUDES	SIZE	UOM	CASE
MBAF-1	Natural	4 Standard Markers & Eraser	20-3/8"L x 2"W x 39"H	Set	1
MBAF-3	Mahogany	4 Standard Markers & Eraser	20-3/8"L x 2"W x 39"H	Set	1
MBAF-4	Mahogany	4 Standard, 2 Deluxe Plus Markers & Eraser	25-1/4"L x 2"W x 45"H	Set	1
MBAF-5	Premium White Oak	2 Standard, 4 Deluxe Plus Markers & Eraser	25-1/4"L x 2"W x 45"H	Set	1

### PREMIUM TRIPOD DISPLAY EASEL

- ◆ A stylish lift to the wood frame marker boards
- ◆ Solid, 1" thick wooden frame has two adjustable deluxe planes with pure copper knobs, comes with rubber feet
- ◆ Factory assembled ensures superior stability over knock-down easels



MBB-3 AND MBBE-3 GROUP

ITEM #	DESCRIPTION	SIZE	UOM	CASE
MBBE-3	Mahogany	23-1/4"L x 1"W x 61"H	Set	1

With floral ink to deliver the most vivid color, the Deluxe Plus markers write on every kind of surface.

ITEM #	DESCRIPTION	SIZE	COLOR	UOM	CASE
MBPM-B	Deluxe Plus	15g Ink, 1/16" Chisel	Neon Blue	Each	72/288
MBPM-G	Deluxe Plus	15g Ink, 1/16" Chisel	Neon Green	Each	72/288
MBPM-O	Deluxe Plus	15g Ink, 1/16" Chisel	Neon Orange	Each	72/288
MBPM-P	Deluxe Plus	15g Ink, 1/16" Chisel	Neon Pink	Each	72/288
MBPM-R	Deluxe Plus	15g Ink, 1/16" Chisel	Neon Red	Each	72/288
MBPM-U	Deluxe Plus	15g Ink, 1/16" Chisel	Neon Purple	Each	72/288
MBPM-W	Deluxe Plus	15g Ink, 1/16" Chisel	Neon White	Each	72/288
MBPM-Y	Deluxe Plus	15g Ink, 1/16" Chisel	Neon Yellow	Each	72/288
MBM-B	Standard	12g Ink, 1/4" Bullet	Neon Blue	Each	72/288
MBM-G	Standard	12g Ink, 1/4" Bullet	Neon Green	Each	72/288
MBM-P	Standard	12g Ink, 1/4" Bullet	Neon Pink	Each	72/288
MBM-R	Standard	12g Ink, 1/4" Bullet	Neon Red	Each	72/288
MBM-W	Standard	12g Ink, 1/4" Bullet	Neon White	Each	72/288
MBM-Y	Standard	12g Ink, 1/4" Bullet	Neon Yellow	Each	72/288
MB-E	Easy Wipe Eraser			Each	72/288

### DELUXE NEON MARKERS & ERASER



MB-E



DELUXE PLUS SERIES

STANDARD SERIES

## VIRTUOSO COFFEE URNS

SEE PAGE 34  
FOR MATCHING  
VIRTUOSO  
CHAFFERS



905A



903B

The modern design of the Virtuoso urns will add a stylish touch to any coffee and tea self-service station. The gleaming mirror-finish body is available in 3-gallon and 5-gallon capacities. A single fuel canister will keep contents warm and ready for dispensing.

- ◆ Made of extra-heavyweight stainless steel
- ◆ Available with gold accent legs or all stainless steel finish

### VIRTUOSO COFFEE URNS

ITEM	DESCRIPTION	UOM	CASE
905A	5 Gallon, Gold Legs	Set	1
905B	5 Gallon, S/S	Set	1
903A	3 Gallon, Gold Legs	Set	1
903B	3 Gallon, S/S	Set	1
FAUCET-CU	Stainless Steel Faucet	Each	1
FAUCET-JD	Plastic Faucet	Each	1



FAUCET-CU



FAUCET-JD

## JUICE DISPENSERS

The container of each dispenser holds up to 2.2 gallons and features an ice core in the center that keeps juices chilled without watering them down.

- ◆ Available with gold accents or in all stainless steel
- ◆ Mirror finish
- ◆ Removable container and drip tray for easy cleaning
- ◆ Break-resistant polycarbonate containers



901  
10-1/8"L x 13-3/4"W x 21-1/4"H



902  
10-1/8"L x 13-3/4"W x 21-1/4"H

### SINGLE JUICE DISPENSERS

ITEM	DESCRIPTION	UOM	CASE
901	Two-tone	Set	1
902	Stainless Steel	Set	1

### ACCESSORIES FOR JUICE DISPENSERS

ITEM	DESCRIPTION	UOM	CASE
901-FN	Faucet for 901, 902	Each	12
901-P1	PC Jar for 901, 902	Each	4



901-FN



901-P1

## PUNCH BOWL

### PUNCH BOWL

- ◆ Stainless steel mirror finish



SPB-35

ITEM	DESCRIPTION	UOM	CASE
SPB-35	3-1/2 Gal Punch Bowl with Decorative Ring Hdl's	Each	6



### ICED TEA DISPENSERS

*This tall and slender iced tea dispensers are the ideal solution for narrow countertops.*

- ◆ Made of stainless steel with a welded front handle
- ◆ Tall faucet with a detachable drip tray
- ◆ Includes 3 color decals: "Iced Tea", "Lemonade" and "Iced Coffee", as well as 1 blank decal for customization

ITEM	DESCRIPTION	SIZE	UOM	CASE
SSBD-3	3 Gal Dispenser	6-7/8"W x 13-3/4"D x 21"H	Set	1
SSBD-5	5 Gal Dispenser	6-7/8"W x 18-7/8"D x 21-1/4"H	Set	1



3 color and 1 blank decal included

### ICED TEA DISPENSERS



### PLASTIC BEVERAGE DISPENSERS

*An excellent option for limited counter spaces, the 3 gallon slim rectangular beverage dispenser has a graduated reservoir that detaches from an 8" high stand to pack up neatly for compact storage. For more spacious counters, a 3 gallon square dispenser is also available.*

- ◆ Leak-proof faucet
- ◆ Detachable drip tray and lid
- ◆ BPA-free

ITEM	DESCRIPTION	UOM	CASE
PBD-3	3 Gal Slim Rectangular Dispenser	Each	1
PBD-3SK	3 Gal Square Dispenser	Each	4
PBD-3-F	Faucet for PBD-3	Each	1
PBD-3SK-F	Faucet for PBD-3SK	Each	50

### PLASTIC BEVERAGE DISPENSERS



PBD-3SK

PBD-3 NSF

PBD-SERIES BPA FREE

### PLASTIC BEVERAGE DISPENSERS

*Perfect for mixing and serving a variety of beverages, this container dispenser comes with a snap-on lid and fitted with a handle for secure and easy transport.*

- ◆ Leak-proof faucet
- ◆ Bail handle with comfortable handgrip
- ◆ Red graduations in liters and quarts
- ◆ Temperature ranges from -40°F to 160°F
- ◆ Dishwasher safe
- ◆ BPA-free

ITEM	DESCRIPTION	UOM	CASE
PBDW-22	6 Gal, PP	Each	4
PBDW-FS	Faucet for PBDW-22	Each	1

### BEVERAGE CONTAINER DISPENSERS



PBDW-22

PBDW-SERIES BPA FREE

AIRPOTS



APSK-725



APSP-925DC

\*SWIVEL BASE\*



STAINLESS STEEL LINED AIRPOTS

- ◆ Available with push button or lever top
- ◆ Heat retention: 10 hours at 175°F; 24 hours at 151°F
- ◆ Double-wall insulated
- ◆ Stainless steel satin-finish body

ITEM	DESCRIPTION	UOM	CASE
APSK-725	2.5L Lever Top	Each	6
APSK-725DC	2.5L Lever Top, Decaf	Each	6
APSK-730	3L Lever Top	Each	6
APSK-730DC	3L Lever Top, Decaf	Each	6
APSP-925	2.5L Push Button	Each	6
APSP-925DC	2.5L Push Button, Decaf	Each	6
APSP-930	3L Push Button	Each	6
APSP-930DC	3L Push Button, Decaf	Each	6



AP-522



AP-822DC

\*SWIVEL BASE\*



GLASS LINED AIRPOTS

- ◆ Available with push button or lever top
- ◆ Heat retention: 10 hours at 171°F; 24 hours at 147°F
- ◆ Double-wall insulated
- ◆ Stainless steel satin-finish body

ITEM	DESCRIPTION	UOM	CASE
AP-522	2.2L Push Button	Each	6
AP-522DC	2.2L Push Button, Decaf	Each	6
AP-525	2.5L Push Button	Each	6
AP-525DC	2.5L Push Button, Decaf	Each	6
AP-535	3L Push Button	Each	6
AP-535DC	3L Push Button, Decaf	Each	6
AP-822	2.2L Lever Top	Each	6
AP-822DC	2.2L Lever Top, Decaf	Each	6
AP-825	2.5L Lever Top	Each	6
AP-825DC	2.5L Lever Top, Decaf	Each	6
AP-835	3L Lever Top	Each	6
AP-835DC	3L Lever Top, Decaf	Each	6

## WIRE AIRPOT RACKS

*Ideal for countertop self-service. Economize space and keep service areas tidy with sturdy wire airpot racks. Available in both single and double-tiers.*

- ◆ Ideal for self-service countertop beverage stations
- ◆ Features 4 sizes that accommodate different configurations
- ◆ Sturdy 1/4" thick heavy-duty wire construction resists bending or breaking
- ◆ Includes removable stainless steel drip tray(s) for easy cleanup
- ◆ Each rack features a sign holder to identify contents
- ◆ Fits Winco® APSK, APSP and AP-series airpots

ITEM	DESCRIPTION	UOM	CASE
APRK-2	Single Level, Holds 2 Airpots	Set	4
APRK-3	Single Level, Holds 3 Airpots	Set	4
APRK-4	Two Levels, Holds 4 Airpots	Set	2
APRK-6	Two Levels, Holds 6 Airpots	Set	2

## WIRE AIRPOT RACKS



Shown with 2 airpots on elevated legs attachment



APRK-3  
15"L X 12"D X 19"H (WITH SIGN)



APRK-2  
22"L X 12"D X 19"H (WITH SIGN)



APRK-6  
22"L X 25"D X 26-1/2"H (WITH SIGN)



APRK-4  
15"L X 25"D X 26-1/2"H (WITH SIGN)

## BEVERAGE DISPENSERS



SBD-1.5



### GRAVITY BEVERAGE DISPENSER WITH SIGHT GLASS

An ideal solution for busy self-service stations, this gravity beverage dispenser features a sight glass to view level of contents for refill needs and a brew-thru lid for brewing directly into the dispenser.

- ◆ Patented structure easily detaches body from stand
- ◆ Tomlinson® faucet with protection guard
- ◆ Double-wall vacuum insulated
- ◆ Retains heat for 4-6 hours
- ◆ Sturdy plastic handle for easy lifting and carrying
- ◆ Stainless steel satin-finish

ITEM	DESCRIPTION	UOM	CASE
SBD-1.5	1.5 Gal	Each	1

## STAINLESS STEEL BEVERAGE SIGNS



SGN-SERIES TENT SIGNS

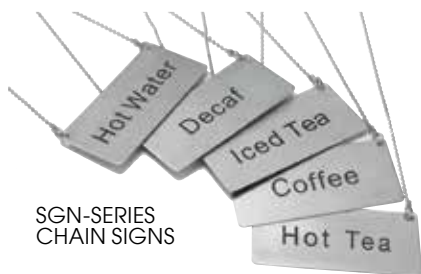

SGN-SERIES CHAIN SIGNS

With oversized black letters on stainless steel, these beverage tent and chain signs are must-haves for buffets and beverage stations.

### TENT SIGNS

- ◆ 3"L x 1-1/4"H x 1-1/2"D

ITEM	DESCRIPTION	UOM	CASE
SGN-100	Blank Sign	Each	12/120
SGN-101	Hot Tea	Each	12/120
SGN-102	Decaf	Each	12/120
SGN-103	Coffee	Each	12/120
SGN-104	Hot Water	Each	12/120
SGN-105	Iced Tea	Each	12/120

### CHAIN SIGNS

- ◆ 3-1/2"L x 1-3/4"W sign with 12" long chain

ITEM	DESCRIPTION	UOM	CASE
SGN-201	Hot Tea	Each	12/120
SGN-202	Decaf	Each	12/120
SGN-203	Coffee	Each	12/120
SGN-204	Hot Water	Each	12/120
SGN-205	Iced Tea	Each	12/120

## DRIP TRAYS



DT-45



DT-60



### DRIP TRAYS

- ◆ Dishwasher safe; removable grid.

ITEM	DESCRIPTION	UOM	CASE
DT-45	4-1/2" Tray, 4-Pcs/Pk	Pack	12/24
DT-60	6" Tray, 4-Pcs/Pk	Pack	12/24



DT-SERIES



**SWIRL DESIGN PUSH BUTTON BEVERAGE SERVERS**

- ◆ Double-wall insulated with durable plastic body
- ◆ Includes tags for regular, decaf and tea
- ◆ Available in black or white
- ◆ Hand wash only

ITEM	DESCRIPTION	UOM	CASE
VSW-20W	20 Oz, White	Each	24
VSW-42W	42 Oz, White	Each	12
VSW-64W	64 Oz, White	Each	6
VSW-20K	20 Oz, Black	Each	24
VSW-42K	42 Oz, Black	Each	12
VSW-64K	64 Oz, Black	Each	6

**INSULATED SERVERS**



VSW-64W

VSW-64K

**STAINLESS STEEL LINED COFFEE SERVER**

- ◆ Double-wall insulated; satin-finish

ITEM	DESCRIPTION	UOM	CASE
VSS-508	20 Oz	Each	12



ALL STAINLESS STEEL

VSS-508

**CARAFES**

- ◆ Stainless steel lined
- ◆ Heat retention: 6 hours at 171°F; 24 hours at 121°F
- ◆ Double-wall insulated
- ◆ Push button

ITEM	DESCRIPTION	UOM	CASE
CF-1.2	1.2L	Each	8
CF-1.5	1.5L	Each	8
CF-2.0	2L	Each	8
CF-LID	Lid for CD-1.2/1.5/2.0	Each	1



CF-1.5

CF-2.0

CF-1.2

**COFFEE/CREAM SERVERS**

- ◆ Double-wall stainless steel vacuum insulation keeps liquids hot or cold for a longer period of time
- ◆ Stainless steel lined interior provides extra durability and safety

ITEM	DESCRIPTION	UOM	CASE
VSS-24	24 Oz	Each	12
VSS-33	33 Oz	Each	12



VSS-24

VSS-33

## STAINLESS STEEL PITCHERS



WPB-2H



WPB-2CH



WPB-2



WPB-2C



BS-64



WPG-64



GS-10



JB2920



W632



## HAMMERED BELL PITCHERS

Stylish and versatile, the hammered mirror-finish bell pitcher is great for serving cold beverages. Ice guard version also available!

ITEM	DESCRIPTION	UOM	CASE
WPB-2H	2 Qt	Each	24
WPB-2CH	2 Qt w/Ice Guard	Each	24
WPB-3H	3 Qt	Each	24
WPB-3CH	3 Qt w/Ice Guard	Each	24

## DELUXE BELL PITCHERS

ITEM	DESCRIPTION	UOM	CASE
WPB-2	2 Qt	Each	24
WPB-2C	2 Qt w/Ice Guard	Each	24
WPB-3	3 Qt	Each	24
WPB-3C	3 Qt w/Ice Guard	Each	24

## CLASSIC COFFEE & WATER SERVERS

ITEM	DESCRIPTION	UOM	CASE
BS-64	64 Oz Coffee Server	Each	12
WPG-64	64 Oz Water Pitcher with Ice Guard	Each	12



## SERVER/CREAMER

ITEM	DESCRIPTION	UOM	CASE
GS-10	10 Oz, Gooseneck	Each	6/72



## GOOSENECK TEAPOT

ITEM	DESCRIPTION	UOM	CASE
JB2920	20 Oz	Each	24
JB2932	32 Oz	Each	24



## SHORT SPOUT BEVERAGE SERVERS

ITEM	DESCRIPTION	UOM	CASE
W612	12 Oz	Each	50
W632	32 Oz	Each	50
W670	70 Oz	Each	30

## TEA ACCESSORIES



GHT-10



GHT-10C



STB-7

## GLASS HOTTLE

- ◆ Non-slip, heat resistant plastic grip
- ◆ Can also be used to steep tea
- ◆ Includes plastic lid
- ◆ Dishwasher safe

ITEM	DESCRIPTION	UOM	CASE
GHT-10	10 Oz	Each	12/24
GHT-10C	Replacement Lid for GHT-10	Each	12/600

## TEA INFUSER BALL

- ◆ Stainless steel

ITEM	DESCRIPTION	UOM	CASE
STB-5	2"	Each	40/240
STB-7	3"	Each	40/240

**WATER PITCHERS**

◆ BPA-free break-resistant SAN plastic

ITEM	DESCRIPTION	UOM	CASE
WPS-32	32 Oz, 4-Pcs/Pk	Pack	12
WPS-60	60 Oz, 4-Pcs/Pk	Pack	8



**WATER PITCHER WITH ICE TUBE**

ITEM	DESCRIPTION	UOM	CASE
WPIT-19	64 Oz, PC	Each	12

**THREE-SPOUT WATER PITCHERS**

ITEM	DESCRIPTION	UOM	CASE
WPCT-60A	60 Oz, Amber, PC	Each	12
WPCT-60C	60 Oz, Clear, PC	Each	12

**SINGLE SPOUT CLEAR WATER PITCHERS**

ITEM	DESCRIPTION	UOM	CASE
WPC-32	32 Oz, PC	Each	12
WPC-48	48 Oz, PC	Each	12
WPC-60	60 Oz, PC	Each	12

**BEER PITCHER**

ITEM	DESCRIPTION	UOM	CASE
WPCB-60	60 Oz, PC	Each	12

**DECANTERS WITH FLIP TOP LIDS**

◆ NSF listed

ITEM	DESCRIPTION	UOM	CASE
PDT-05	0.5 Qt, PC	Each	24
PDT-10	1 Qt, PC	Each	24
PDT-15	1.6 Qt, PC	Each	24



**HAVANA TUMBLERS**

◆ BPA-free break-resistant SAN plastic  
◆ Safe for commercial dishwasher

ITEM	DESCRIPTION	SIZE	UOM	CASE
PTSN-9	Blue	9 Oz	Doz	6
PTSN-12	Blue	12 Oz	Doz	6
PTSN-16	Blue	16 Oz	Doz	4



**PEBBLED TUMBLERS**

ITEM	DESCRIPTION	SIZE	UOM	CASE
PTP-05A	Amber	5 Oz	Doz	6
PTP-05B	Blue	5 Oz	Doz	6
PTP-05C	Clear	5 Oz	Doz	6
PTP-05R	Red	5 Oz	Doz	6
PTP-08A	Amber	8 Oz	Doz	6
PTP-08B	Blue	8 Oz	Doz	6
PTP-08C	Clear	8 Oz	Doz	6
PTP-08R	Red	8 Oz	Doz	6
PTP-09A	Amber	9-1/2 Oz	Doz	6
PTP-09B	Blue	9-1/2 Oz	Doz	6
PTP-09C	Clear	9-1/2 Oz	Doz	6
PTP-09R	Red	9-1/2 Oz	Doz	6
PTP-12A	Amber	12 Oz	Doz	6
PTP-12B	Blue	12 Oz	Doz	6
PTP-12C	Clear	12 Oz	Doz	6
PTP-12R	Red	12 Oz	Doz	6
PTP-16A	Amber	16 Oz	Doz	6
PTP-16B	Blue	16 Oz	Doz	6
PTP-16C	Clear	16 Oz	Doz	6
PTP-16R	Red	16 Oz	Doz	6
PTP-20A	Amber	20 Oz	Doz	2
PTP-20B	Blue	20 Oz	Doz	2
PTP-20C	Clear	20 Oz	Doz	2
PTP-20R	Red	20 Oz	Doz	2
PTP-24A	Amber	24 Oz	Doz	2
PTP-24B	Blue	24 Oz	Doz	2
PTP-24C	Clear	24 Oz	Doz	2
PTP-24R	Red	24 Oz	Doz	2
PTP-32A	Amber	32 Oz	Doz	2
PTP-32B	Blue	32 Oz	Doz	2
PTP-32C	Clear	32 Oz	Doz	2
PTP-32R	Red	32 Oz	Doz	2

**PLASTIC PITCHERS**



WPS-32

**BPA FREE**

WPS-60

**BPA FREE**



WPIT-19

WPCT-60A

WPCT-60C



WPC-SERIES

**NSF**

WPCB-60

PDT-SERIES

**NSF**

**PLASTIC DRINKWARE**



PTSN-SERIES

**BPA FREE**



PTP-SERIES-COLORS



PTP-SERIES



**ELECTRIC COFFEE WARMERS**

**ELECTRIC COFFEE WARMERS**

Keep coffee fresh, hot and ready to serve at the optimal serving temperature. Coffee warmers are ideal for any self-service area.

**NEW SIZE**

ECW-2S



ECW-2



ECW-1



ECW-SERIES

- ◆ Low-profile for maximum product visibility and countertop space conservation
- ◆ Durable stainless steel construction with ceramic plates
- ◆ Separate on/off switches for simple and convenient operation
- ◆ 120V~60Hz, 100W per burner
- ◆ ETL Safety and Sanitation listed

ITEM	DESCRIPTION	UOM	CASE
ECW-1	Single Burner	Each	6
ECW-2	Double Burners	Each	6
ECW-2S	Step-Up Double Burner	Each	1

**COFFEE PRESS**

**FRENCH PRESS**

FPCM-33



- ◆ Stainless steel frame with polypropylene handle
- ◆ Can also be used with loose leaf teas
- ◆ Glass carafe holds approximately 4 cups

ITEM	DESCRIPTION	UOM	CASE
FPCM-33	33 Oz, 3-3/4"Dia	Each	12

**COFFEE ACCESSORIES**

**COFFEE SCOOP**



CSP-6

- ◆ Measures 1 tablespoon, long handle
- ◆ Fingerprint-resistant satin finish, 18/8 stainless steel

ITEM	DESCRIPTION	UOM	CASE
CSP-6	6" L	Each	12/288



WP-66



CD-64

**STAINLESS STEEL FROTHING PITCHERS**

ITEM	DESCRIPTION	UOM	CASE
WP-14	14 Oz	Each	48
WP-20	20 Oz	Each	48
WP-33	33 Oz	Each	36
WP-50	50 Oz	Each	24
WP-66	66 Oz	Each	24

**STAINLESS STEEL COFFEE SERVER**

ITEM	DESCRIPTION	UOM	CASE
CD-64	64 Oz w/Cover	Each	12



CD-64K



CD-64O

**COFFEE DECANTERS**

- ◆ Use with coffee machines ONLY (no stove or gas burners)
- ◆ Stainless steel base

ITEM	DESCRIPTION	UOM	CASE
CD-64K	64 Oz Regular	Each	24
CD-64O	64 Oz Decaf	Each	24

**COFFEE DREDGE KNOCK BOX**

- ◆ Made of 23 gauge stainless steel
- ◆ Fits any 1/6th size opening

ITEM	DESCRIPTION	UOM	CASE
SCD-5	7"L x 6"W x 5"H	Each	24

**COFFEE DECANTER BRUSH**

ITEM	DESCRIPTION	UOM	CASE
CDB-11	11"L x 1-1/4"W x 1-1/4"H	Each	12/96

**COFFEE EQUIPMENT BRUSH**

ITEM	DESCRIPTION	UOM	CASE
BR-25	25"	Each	12/96



SCD-5



CDB-11



BR-25



### CUP DISPENSING RACKS

Keep self-service counters neat and tidy with this economical organizer for paper, plastic or foam cups.

- ◆ Dispenses one at a time
- ◆ Can be loaded from the front or back
- ◆ Suction feet secure organizer to a flat surface
- ◆ For cups from 8 oz to 44 oz w/rims between 3-1/8" and 4" diameter
- ◆ Available with three (3) or four (4) tiers

ITEM	DESCRIPTION	UOM	CASE
CDR-3	3-Tier	Each	2
CDR-4	4-Tier	Each	2

### CUP RACKS

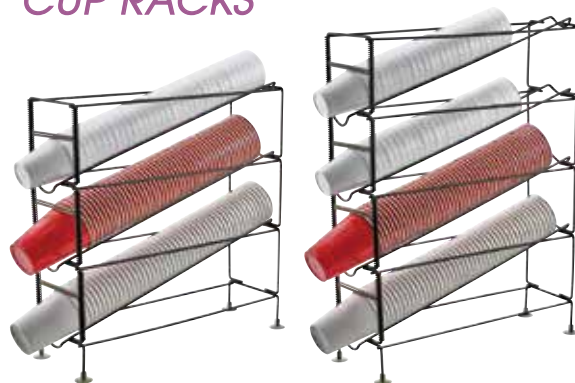

CDR-3  
20"L X 6-1/4"W X 19-1/4"H

CDR-4  
20"L X 6-1/4"W X 24-3/4"H



Simply twist springs to adjust for different cup sizes

### CUP & LID ORGANIZERS

The ideal solution for busy self-service stations with limited countertop space. These cup and lid organizers are made of durable ABS plastic that is easy to clean. Multi-functional compartments keep cups, lids, condiments and stirrers in their place.

ITEM	DESCRIPTION	UOM	CASE
CLO-2D	2 Tiers & 2 Stacks	Each	4
CLO-3D	2 Tiers & 3 Stacks	Each	4
CLSO-2T	3 Tiers & 2 Stacks	Each	4
CLSO-3T	3 Tiers & 3 Stacks	Each	4

### CUP ORGANIZERS



CLO-2D  
8-1/2"L x 8-5/8"W x 12-1/4"H



CLO-3D  
12-11/16"L x 8-5/8"W x 12-1/4"H



CLSO-2T  
8-1/2"L x 13-1/16"W x 12-3/16"H

CLSO-3T  
12-5/16"L x 12-3/4"W x 13-1/8"H

### IN-COUNTER CUP DISPENSER

Made for fast-food environments and busy self-service stations, this convenient and space-efficient in-counter cup dispenser utilizes a spring-loaded design to allow for one-at-a-time dispensing in horizontal, angled or vertical mounting positions.

- ◆ Made of durable ABS plastic
- ◆ Designed for cups with rim diameters from 3-1/8" to 4-1/2"
- ◆ Built-in clips allow dispenser to be adjusted without removing from the counter

ITEM	DESCRIPTION	UOM	CASE
CDIC-4	24"L x 5.25"Dia	Each	9

### CUP DISPENSER



CDIC-4

## DISPLAY TRAYS & RISERS



HRS-4



HPO-12

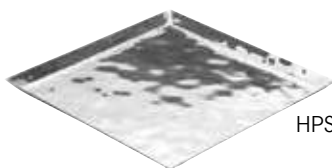

HPS-12



HPR-10

Made of 18/8 stainless steel, the surfaces of these trays and risers exhibit a glossy ripple effect in gleaming mirror finish, making them truly unique and elegant pieces for showcasing appetizers and desserts.

- ◆ Durable and stable surface for displaying
- ◆ Not recommended for prolonged use with acidic, creamy or salty ingredients
- ◆ Hand wash recommended

### NESTING RISER DISPLAY

- ◆ 4-piece nesting set

ITEM	DESCRIPTION	UOM	CASE
HRS-4	Riser 1: 5-1/2" x 5-1/2" x 5-1/2" Riser 2: 6-5/8" x 6-5/8" x 6-5/8" Riser 3: 7-7/8" x 7-7/8" x 7-7/8" Riser 4: 9" x 9" x 9"	Set	4

### DISPLAY TRAYS

- ◆ Available in a variety of shapes and sizes

ITEM	DESCRIPTION	UOM	CASE
HPO-12	Rectangular 12-5/8" x 7-1/4" x 1"	Each	12
HPO-14	Rectangular 13-3/4" x 7-3/4" x 1"	Each	12
HPO-15	Rectangular 15" x 8-1/2" x 1"	Each	12
HPS-10	Square 10-1/4" x 10-1/4" x 5/8"	Each	12
HPS-12	Square 11-3/4" x 11-3/4" x 5/8"	Each	12
HPS-13	Square 13-1/4" x 13-1/4" x 5/8"	Each	12
HPR-8	Round 8-7/8"Dia x 1-5/8"	Each	12
HPR-9	Round 9-5/8"Dia x 1-5/8"	Each	12
HPR-10	Round 10-1/4"Dia x 1-5/8"	Each	12

## DISPLAY BOWLS



TDS-3

TDSF-4

### TIERED GLASS BOWL DISPLAYS

These multi-tiered glass bowl servers provide a modern and attractive way to display cold salads, fruits and breads.

- ◆ 18/8 stainless steel mirror finish arms and bases
- ◆ Glass bowls are removable for easy cleaning, and microwave and dishwasher safe
- ◆ Available in 3-tier graduated set or 4-tier arm set
- ◆ Arms on the 4-tier set rotate 360°

ITEM	DESCRIPTION	UOM	CASE
TDS-3	3-Tier Set Base 9-3/4"Dia x 19-3/4"H	Set	1
TDSF-4	4-Tier Set Base 8-3/4"Dia x 20-1/2"H	Set	1
TDS-3-GLAS	Glass Bowl for TDS-3	Each	12
TDSF-4-GLS	Glass Bowl for TDSF-4	Each	12



DWAB-S



DWAB-L

### DOUBLE-WALL ANGLED DISPLAY BOWLS

A perfect mix of form and function, this stainless steel double-wall insulated bowl features indentations to allow for it to stand flat or at an angle.

- ◆ Maintains serving temperature for extended period of time without sweating or beading

ITEM	DESCRIPTION	UOM	CASE
DWAB-S	1-1/2 Qt	Each	12
DWAB-L	2-1/4 Qt	Each	6

### SEAFOOD TRAYS

Create an enticing tabletop spread with these trays in assorted sizes for displaying seafood or appetizers. The brushed aluminum construction retains cold and keeps foods at safe serving temperatures.

ITEM	DESCRIPTION	UOM	CASE
ASFT-12	12"Dia x 1-1/2"H	Each	12/36
ASFT-14	13-3/4"Dia x 1-1/2"H	Each	12/36
ASFT-16	15-3/4"Dia x 1-1/2"H	Each	12/24
ASFT-18	17-3/4"Dia x 1-1/2"H	Each	12/24
ASFT-20	19-3/4"Dia x 1-1/2"H	Each	12



### CHROME-PLATED SEAFOOD TRAY RACKS

- ◆ Use with ASFT-series seafood trays to create appealing tabletop presentations
- ◆ Also perfect for elevating serving plates, bowls and platters, as well as holding pizza pans

ITEM	DESCRIPTION	UOM	CASE
SFR-4	7-3/8" Top Dia / 9-5/8" Bottom Dia x 4-3/8"H	Each	20
SFR-7	7-3/8" Top Dia / 9-5/8" Bottom Dia x 7"H	Each	20

### SEAFOOD TRAYS



ASFT-12

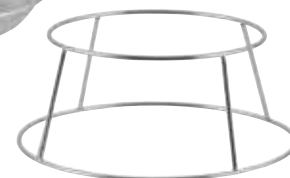

SFR-4



### PEARL SHELL BOWLS

Made of light-weight ABS plastic, these shell bowls are ideal for displaying cold foods and salads.

ITEM	DESCRIPTION	UOM	CASE
PSBW-1W	20 Oz	Each	12/48
PSBW-5W	5 Qt	Each	6/12

### BOWLS & CROCKS



PSBW-1W

PSBW-5W

### PEBBLED SALAD BOWLS

- ◆ Made of durable polycarbonate, these clear pebbled bowls are perfect for salads, fruits, desserts and snacks
- ◆ NSF listed

ITEM	DESCRIPTION	UOM	CASE
PBB-6	6"	Each	96
PBB-8	8"	Each	48
PBB-10	10"	Each	24
PBB-12	12"	Each	24
PBB-15	15"	Each	12
PBB-18	18"	Each	12



PBB-10

PBB-SERIES



### DELI CROCKS & COVERS

Beautiful fluted finish combined with durable SAN plastic makes these crocks ideal for deli counter and picnic buffet presentations.

- ◆ BPA-free

ITEM	DESCRIPTION	COLOR	UOM	CASE
CRK-10R	10" x 7" x 3"	Red	Each	24
CRK-10K	10" x 7" x 3"	Black	Each	24
CRK-10C	10" x 7" x 3"	Clear	Each	24
CRK-10W	10" x 7" x 3"	White	Each	24
CRK-13R	13" x 10" x 3"	Red	Each	12
CRK-13K	13" x 10" x 3"	Black	Each	12
CRK-13C	13" x 10" x 3"	Clear	Each	12
CRK-13W	13" x 10" x 3"	White	Each	12
CRKC-10	Cover for CRK-10 Series	Clear	Each	48
CRKC-13	Cover for CRK-13 Series	Clear	Each	48



CRK-SERIES



CRK & CRKC SERIES



CRKC-13

CRKC-10



## ACRYLIC & PLASTIC DISPLAYS



CKS-13  
& CKS-13C



ADC-4



ADC-2



ADC-3



C-DP1

**NSF** DOME COVERS



C-DPF1



C-DPF2



C-DPFH

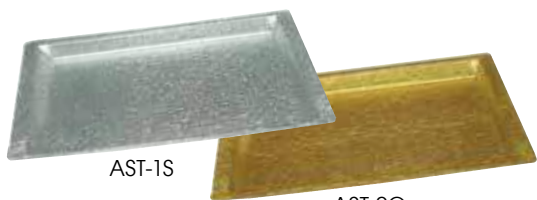

AST-1S

AST-2G



ACN-4

### CAKE STAND & COVER

- ◆ Assembly required for cake stand and cover
- ◆ Covers available for full case purchase only

ITEM	DESCRIPTION	UOM	CASE
CKS-13	13"Dia Stand, S/S	Each	6/12
CKS-13C	12"Dia Cover, Plastic	Each	6

### ACRYLIC DISPLAY CASES

ITEM	DESCRIPTION	SIZE	UOM	CASE
ADC-2	2-Tray, Front & Rear Doors	21" x 18" x 12"	Set	1
ADC-3	3-Tray, Rear Door	21" x 18" x 16-1/2"	Set	1
ADC-4	4-Tray, Front & Rear Doors	14" x 24" x 24"	Set	1
ADC-TY	Tray for All Display Cases		Each	12

### DOME COVERS

- ◆ Made of durable polycarbonate plastic
- ◆ Full-size dome can be used with AST-1S and AST-1G display trays
- ◆ C-DP1 & C-DPF1 fits full-size steam table pans and poly pans
- ◆ C-DP2 & C-DPF2 fits half-size steam table pans and poly pans
- ◆ NSF listed

ITEM	DESCRIPTION	SIZE	UOM	CASE
C-DP1	Full-size Cover	21-1/2" x 13-3/4"	Each	12
C-DP2	Half-size Cover	13-1/2" x 11"	Each	24
C-DPF1	Full-size Flip Cover	21-1/2" x 13-3/4"	Each	12
C-DPF2	Half-size Cut-out Cover	13-1/2" x 11"	Each	24

### HINGED DOME COVER

- ◆ Made of polycarbonate
- ◆ Fits full-size steam table pans and poly pans

ITEM	DESCRIPTION	SIZE	UOM	CASE
C-DPFH	Full-size Hinged Cover	21" x 13"	Each	12

### ACRYLIC TEXTURED DISPLAY TRAYS

Show off decadent pastries and sweets perfectly with the acrylic snake-skin textured display trays in silver or gold.

- ◆ Fits in all above display cases and under dome covers

ITEM	DESCRIPTION	SIZE	UOM	CASE
AST-1S	Silver Tray	20-3/4" x 12-3/4"	Each	24
AST-2G	Gold Tray, Acrylic	20-3/4" x 12-3/4"	Each	24

### ICE CREAM CONE HOLDER

ITEM	DESCRIPTION	SIZE	UOM	CASE
ACN-4	4-Hole Stand	12" x 4" x 4-1/2"	Each	12

### ROLL-TOP COVER

- ◆ 18/8 satin finish stainless steel
- ◆ Fits full-size 12" x 20" opening food pan
- ◆ Plastic handle is heat resistant up to 220°F (105°C)
- ◆ Can be used over standard sized food warmers/cookers

ITEM	DESCRIPTION	UOM	CASE
C-RCF	20-3/4"L x 13"W x 11-7/8"H	Each	2



### ROLL-TOP COVER



C-RCF



### FIBERGLASS MARKET TRAYS

- ◆ Market trays are a must-have for displaying bakery and pastry items
- ◆ Edges reinforced with aluminum rods to prevent warping
- ◆ Molded-in lugs allow air circulation between stacked trays for quick drying
- ◆ NSF listed

ITEM	DESCRIPTION	COLOR	UOM	CASE
FGMT-0926C	9" x 26"	Cream	Each	12
FGMT-0926K	9" x 26"	Black	Each	12
FGMT-0926W	9" x 26"	White	Each	12

### TRAYS & BASKETS



FGMT-0926K  
26"L X 9"W



Reinforced

Available tray colors:

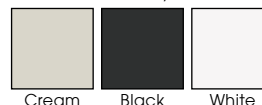

Cream

Black

White

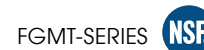

### ANGLED DISPLAY ADAPTOR

Add some dimension to a buffet with an angled display adaptor to give steam table pans a lift to give guests a better view and easier access to food.

ITEM	DESCRIPTION	UOM	CASE
ADB-4	Full-size, S/S	Each	2/6

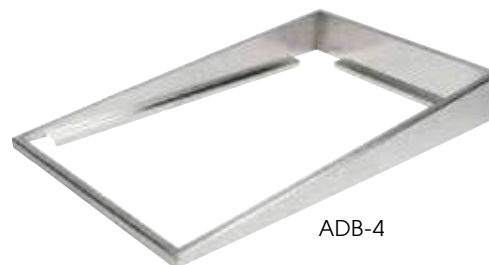

ADB-4



### SOLID CORD POLY WOVEN BASKETS

- ◆ Flexible with reinforced weaving on rim and base for added durability
- ◆ Easily stackable
- ◆ Dishwasher safe

ITEM	DESCRIPTION	UOM	CASE
PWBK-1914T	Rectangular with Handles, Black, 3-Pcs/Pk	Pack	4
PWBN-1914T	Rectangular with Handles, Natural, 3-Pcs/Pk	Pack	4



PWBK-1914T  
19"L X 14"W X 4"H

### NATURAL WOVEN BASKETS WITH HANDLES

ITEM	DESCRIPTION	UOM	CASE
PWBN-12B	12" x 8" x 3"	Each	12/96
PWBN-16B	16" x 11" x 3"	Each	12/48



PWBN-16B



## DISPLAY SIGNAGE BOARDS & ACCESSORIES

- ◆ Perfect for bakeries, cafes, coffee shops, pubs and restaurants
- ◆ Made for frequently changing specials, the High-tech Absol-Flat black glossy surface allows for clean and mess-free writing
- ◆ Solid 1-1/4" wide frame with double reinforced joints
- ◆ Durable packaging prevents damage while in transit



### WOODEN FRAME MARKER BOARDS

ITEM #	DESCRIPTION	INCLUDES	SIZE	UOM	CASE
MBB-1	Natural	1 Standard White Marker & Eraser	23-5/8"L x 3/4"W x 31-5/8"H	Set	6
MBB-3	Mahogany	1 Standard White Marker & Eraser	23-5/8"L x 3/4"W x 31-5/8"H	Set	6

### DUAL-SIDED SIDEWALK A-FRAME MARKER BOARDS

ITEM #	DESCRIPTION	INCLUDES	SIZE	UOM	CASE
MBAF-1	Natural	4 Standard Markers & Eraser	20-3/8"L x 2"W x 39"H	Set	1
MBAF-3	Mahogany	4 Standard Markers & Eraser	20-3/8"L x 2"W x 39"H	Set	1
MBAF-4	Mahogany	4 Standard, 2 Deluxe Plus Markers & Eraser	25-1/4"L x 2"W x 45"H	Set	1
MBAF-5	Premium White Oak	2 Standard, 4 Deluxe Plus Markers & Eraser	25-1/4"L x 2"W x 45"H	Set	1



MBB-3 AND MBBE-3 GROUP

### PREMIUM TRIPOD DISPLAY EASEL

- ◆ A stylish lift to the wood frame marker boards
- ◆ Solid, 1" thick wooden frame has two adjustable deluxe planes with pure copper knobs, comes with rubber feet
- ◆ Factory assembled ensures superior stability over knock-down easels

ITEM #	DESCRIPTION	SIZE	UOM	CASE
MBBE-3	Mahogany	23-1/4"L x 1"W x 61"H	Set	1

## DELUXE NEON MARKERS & ERASER

With floral ink to deliver the most vivid color, the Deluxe Plus markers write on every kind of surface.



Deluxe Plus Broad Chisel Tip Markers



Standard Bullet Tip Markers



MB-E

ITEM #	DESCRIPTION	SIZE	COLOR	UOM	CASE
MBPM-B	Deluxe Plus	15g Ink, 1/16" Chisel	Neon Blue	Each	72/288
MBPM-G	Deluxe Plus	15g Ink, 1/16" Chisel	Neon Green	Each	72/288
MBPM-O	Deluxe Plus	15g Ink, 1/16" Chisel	Neon Orange	Each	72/288
MBPM-P	Deluxe Plus	15g Ink, 1/16" Chisel	Neon Pink	Each	72/288
MBPM-R	Deluxe Plus	15g Ink, 1/16" Chisel	Neon Red	Each	72/288
MBPM-U	Deluxe Plus	15g Ink, 1/16" Chisel	Neon Purple	Each	72/288
MBPM-W	Deluxe Plus	15g Ink, 1/16" Chisel	Neon White	Each	72/288
MBPM-Y	Deluxe Plus	15g Ink, 1/16" Chisel	Neon Yellow	Each	72/288
MBM-B	Standard	12g Ink, 1/4" Bullet	Neon Blue	Each	72/288
MBM-G	Standard	12g Ink, 1/4" Bullet	Neon Green	Each	72/288
MBM-P	Standard	12g Ink, 1/4" Bullet	Neon Pink	Each	72/288
MBM-R	Standard	12g Ink, 1/4" Bullet	Neon Red	Each	72/288
MBM-W	Standard	12g Ink, 1/4" Bullet	Neon White	Each	72/288
MBM-Y	Standard	12g Ink, 1/4" Bullet	Neon Yellow	Each	72/288
MB-E	Easy Wipe Eraser			Each	72/288



### STAINLESS STEEL CONDIMENT HOLDERS

ITEM	DESCRIPTION	UOM	CASE
CDP-4	4 Compartments	Each	16
CDP-5	5 Compartments	Each	16
CDP-6	6 Compartments	Each	16
CDP-1P	1pt Insert for CDP-4/5/6	Each	120
CDP-1Q	1qt Insert for CDP-4/5/6	Each	60

*There is no space for ice under the compartments.*

### PLASTIC BASE CONDIMENT HOLDERS

- ◆ Durable ABS holder with lid & removable food-grade poly inserts
- ◆ Perfect for storing garnish
- ◆ Dishwasher safe

ITEM	DESCRIPTION	SIZE	UOM	CASE
CCH-4	4 Compartments, Black	19-3/8" x 6-1/4" x 3-3/4"	Each	6
CCH-6	6 Compartments, Black	19-7/16" x 6-1/4" x 3-1/2"	Each	6
CCH-4IS	Inserts for CCH-4, 4-Pcs/Pk		Pack	24
CCH-6IS	Inserts for CCH-6, 6-Pcs/Pk		Pack	24
BC-4P	4 Compartments, White	18" x 5" x 3"	Set	6/36

*There is no space for ice under the compartments.*

### BAR CADDY

- ◆ BPA-free

ITEM	DESCRIPTION	UOM	CASE
BC-6	6 Compartments, Plastic	Each	12

### CONDIMENT CADDIES



### DECORATIVE PICKS

- ◆ Available in a variety of colors
- ◆ Hanging card packaging for easy display

ITEM	DESCRIPTION	SIZE	PCS/PK	UOM	CASE
PK-P4	Parasol	3-15/16"	144	Bag	100
PK-S3	Plastic Sword	2-3/4"	500	Bag	20

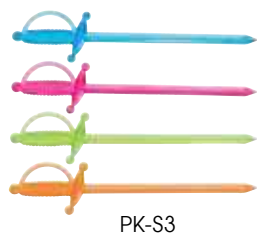

### DECORATIVE PICKS

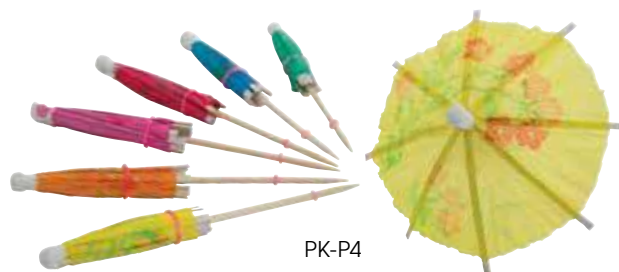

### ACRYLIC STRAW DISPENSER

- ◆ BPA-free

ITEM	DESCRIPTION	UOM	CASE
ACSD-712	10-3/4" x 4-3/4" x 7"	Each	6

### PLASTIC VERTICAL STRAW DISPENSER

- ◆ Break-resistant polycarbonate holder with stainless steel pull-up dispenser feature
- ◆ Capacity 100 straws

ITEM	DESCRIPTION	UOM	CASE
SDP-3	3-3/8"Dia x 10-3/4"H	Each	12

### STRAW DISPENSERS



## MOSCOW MULE MUGS



CMM-20

CMM-20H

AVAILABLE IN  
MAY 2017



NEW

CMM-2



NEW

CMM-2H



## COPPER-PLATED MOSCOW MULE MUGS

Whether serving its classic namesake drink or any refreshing cocktail, these rustic copper-plated mugs will instantly keep drinks extra cold, making them great additions to an outdoor bar setting.

ITEM	DESCRIPTION	UOM	CASE
CMM-20	20 Oz, Smooth Exterior	Each	36
CMM-20H	20 Oz, Hammered Exterior	Each	36



## MINI MOSCOW MULE MUGS

The popular Moscow Mule Mugs are now available in mini versions!

- ◆ 2 oz capacity
- ◆ Great for sauces
- ◆ 4-Pcs/Pk



ITEM	DESCRIPTION	UOM	CASE
CMM-2	2 Oz, Smooth	Pack	6/24
CMM-2H	2 Oz, Hammered	Pack	6/24

## MINT JULEP CUPS

AVAILABLE IN  
MAY 2017



NEW

DDSD-101S



## STAINLESS STEEL MINT JULEP CUPS



ITEM	DESCRIPTION	UOM	CASE
DDSE-101S	3"Dia x 4-3/8"H	Each	12/72
DDSE-102S	3-3/8"Dia x 4-3/4"H	Each	12/72

## MIXING GLASS

NEW

WG10-001



## MIXING GLASS

- ◆ 24-Pcs/Case



ITEM	DESCRIPTION	UOM	CASE
WG10-001	16 Oz	Case	1

## DRINK PREPARATION TOOLS



### BAR SHAKER SETS

- ◆ Stainless steel
- ◆ 3-pc set includes cap, strainer and cup



BS-310

BL-3P

BS-1P

BS-3B

BL-28P

BS-3P



### CLEAR BAR SHAKER

ITEM	DESCRIPTION	UOM	CASE
BS-16PC	16 Oz Clear Bar Shaker	Each	24



BS-16PC

BS-15

BS-30

MCP-30

BS-28P

### BAR SHAKER CUPS

- ◆ Stainless steel

ITEM	DESCRIPTION	UOM	CASE
BS-15	15 Oz Shaker Cup	Each	12/144
BS-30	30 Oz Shaker Cup	Each	12/72
MCP-30	30 Oz Malt Cup	Each	12/72
BS-28P	28 Oz PVC Exterior	Each	24/48



**JAPANESE-STYLE JIGGERS**

- ◆ Stainless steel
- ◆ Rolled rim for easy pour and a high-end look

ITEM	DESCRIPTION	UOM	CASE
J-6	1/2 Oz x 3/4 Oz	Each	12/300
J-7	1/2 Oz x 1 Oz	Each	12/300
J-8	1 Oz x 1-1/4 Oz	Each	12/300
J-9	1 Oz x 2 Oz	Each	12/300

**STANDARD JIGGERS**

- ◆ Stainless steel
- ◆ Flip sides for different capacity measures

ITEM	DESCRIPTION	UOM	CASE
J-1	1/2 Oz x 1 Oz	Each	12/300
J-2	3/4 Oz x 1-1/4 Oz	Each	12/300
J-3	3/4 Oz x 1-1/2 Oz	Each	12/300
J-4	1 Oz x 1-1/2 Oz	Each	12/300
J-5	1 Oz x 2 Oz	Each	12/300

**BAR ACCESSORIES**

- ◆ Stainless steel

ITEM	DESCRIPTION	UOM	CASE
BPS-11	11" Bar Spoon	Each	24/600
BST-4P	Hawthorne Strainer	Each	12/288
JST-1	Julep Strainer	Each	12/240

**STRAINER-SIFTER**

Add an extra twist of citrus right into a cocktail with this 3" strainer. The fine mesh is great for catching pulp and small seeds.

- ◆ Stainless steel

ITEM	DESCRIPTION	UOM	CASE
MS2K-3S	3"Dia x 8"L x 1"H	Each	24/144

**BEER LAYERING SPOON**

A must-have for making black & tans or half & halves, the specially designed ridge of this spoon rests over the lip of the glass to allow for that essential slow pour, creating flawlessly layered beers.

ITEM	DESCRIPTION	UOM	CASE
BLS-6	1-5/8" Dia, S/S	Each	12/48

**GLASS RIMMERS**

ITEM	DESCRIPTION	UOM	CASE
GR-2	2-Tier, Plastic w/Sponge	Each	12
GR-3	3-Tier, Plastic w/Sponge	Each	12
GR-3S	Replacement Sponge, No Retail Packaging	Each	144

**DRINK PREP TOOLS**



NEW

J-7



J-1



J-3

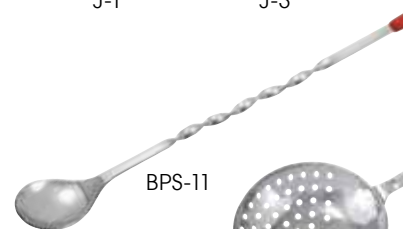

BPS-11



BST-4P



JST-1



MS2K-3S



Beer layering



BLS-6



GR-2



GR-3S



GR-3

## MUDDLERS & SQUEEZERS



JC-16



JC-19



### TABLETOP JUICE SQUEEZERS

ITEM	DESCRIPTION	UOM	CASE
JC-16	Heavy-duty, 15"	Each	6
JC-19	Premium, 19"	Each	2



SBM-8N



WMW-8



PBM-8N



PBM-8T



MPS-42W

### MUDDLERS

◆ 8" long



ITEM	DESCRIPTION	UOM	CASE
SBM-8N	Netted Head, S/S	Each	12/96
WMW-8	Flat Head, Wooden	Each	24/144
PBM-8N	Netted Head, PC	Each	12/216
PBM-8T	Triangular Head, PC	Each	12/216



### MARBLE MORTAR & PESTLE SET

ITEM	DESCRIPTION	UOM	CASE
MPS-42W	4-1/2"Dia Bowl	Set	12



### STAINLESS STEEL MANUAL JUICE SQUEEZER

ITEM	DESCRIPTION	UOM	CASE
JC-4	5"Dia	Each	24



JC-4



LS-3

### STAINLESS STEEL LEMON/LIME SQUEEZER

ITEM	DESCRIPTION	UOM	CASE
LS-3	6"Dia	Each	12/144



### HANDHELD CITRUS SQUEEZERS

*Extract all the juice without the rind, pulp or seeds.*

- ◆ Aluminum with baked-on enamel coating
- ◆ Place citrus half with the cut side down in juicer and extract
- ◆ Dishwasher safe, long lasting, won't absorb odors, and resistant to moisture, heat and stains

ITEM	DESCRIPTION	UOM	CASE
LS-8G	2-1/2"Dia, 8"L	Each	6/48
LS-9O	3-1/2"Dia, 9-1/8"L	Each	9/36
LS-9Y	3"Dia, 8-3/4"L	Each	6/48



LS-8G



LS-9O



LS-9Y

## CUTTING BOARD



### GARNISH CUTTING BOARD

◆ NSF listed

ITEM	DESCRIPTION	UOM	CASE
CBWT-610	6" x 10" x 1/2"	Each	20



NSF CBWT-610

**WING-STYLE CORKSCREWS**

ITEM	DESCRIPTION	UOM	CASE
CO-501	Wing Type, Chrome	Each	12/144
CO-701	Wing Type, Black	Each	12/72



CO-720 double-hinged corkscrew in use

**BOTTLE OPENERS & CORKSCREWS**



**CORKSCREWS**

ITEM	DESCRIPTION	UOM	CASE
CO-720	Double Hinged Corkscrew	Each	6/96
CO-511	Waiter's Corkscrew, S/S, Made in Italy, No Retail Pkg.	Each	12/144
CO-512	Waiter's Corkscrew, Black, Made in Italy, No Retail Pkg.	Each	12/144
CO-711	Waiter's Corkscrew, S/S, Economy	Each	12/144
CO-712	Waiter's Corkscrew, Black, Economy	Each	12/144
CO-4DK	Black, 2-Pcs/Pk	Pack	24/96
CO-4DW	White, 2-Pcs/Pk	Pack	24/96



**FLAT BOTTLE OPENERS**

◆ Stainless steel

ITEM	DESCRIPTION	UOM	CASE
CO-301	Without Coating	Each	12/144
CO-301PB	Blue PVC Coating	Each	12/144
CO-301PK	Black PVC Coating	Each	12/144
CO-301PR	Red PVC Coating	Each	12/144



**CAN TAPPER/BOTTLE OPENER**

ITEM	DESCRIPTION	UOM	CASE
CO-201	Nickel Plated, 4"	Each	100/600
CO-302	Stainless Steel, 7"	Each	12/144
CO-303	Wooden Hdl, S/S, 7"	Each	12/144



**CAN OPENER**

◆ Made in Italy

ITEM	DESCRIPTION	UOM	CASE
CO-530	White Handles	Each	12/72

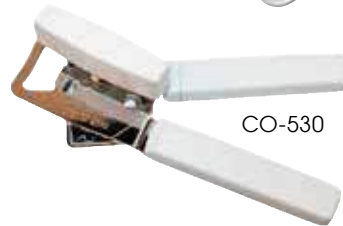

**UNDER-COUNTER STAINLESS STEEL BOTTLE OPENER**

ITEM	DESCRIPTION	UOM	CASE
CO-401	4-1/4"	Each	24/288



**WALL-MOUNT BOTTLE OPENER**

◆ Made of sturdy die-cast zinc alloy  
◆ Wall-mounted for easy accessibility

ITEM	DESCRIPTION	UOM	CASE
CO-402	3-1/4"L x 2-3/4"W	Each	24/144



**BOTTLE CAP CATCH**

ITEM	DESCRIPTION	UOM	CASE
BCH-14	5-1/2"L x 3-1/2"W x 13-3/4"H	Each	24



## COUNTERTOP BLENDER

**ACCELMIX™**  
by Winco®

ADD POWER & PERFORMANCE TO YOUR BAR

NEW



XLB-1000

BPA FREE

TRITAN™ CONTAINER

## COUNTERTOP ELECTRIC BLENDER

- ◆ High-performance motor with impact-resistant stainless steel blades
- ◆ Extra large 68 Oz capacity, break-resistant Tritan™ container is BPA-free
- ◆ Simple "PULSE" and "ON/OFF" paddle controls, and variable speed control dial
- ◆ Removable container cover and cap for adding ingredients mid-cycle, as well as pressure reduction when blending hot foods
- ◆ Commercial-grade quality
- ◆ Container/pitcher is heat-resistant up to 226°F (108°C)
- ◆ Includes an 11-1/2" tamper for blending solid foods
- ◆ Overall dimensions: 20"L x 9"W x 10"D
- ◆ Container dimensions: 11-1/2"H x 6-5/8"W x 6-1/4"D
- ◆ 120V~60Hz, 1450W
- ◆ All parts except base are dishwasher safe
- ◆ One year warranty

ITEM	DESCRIPTION	UOM	CASE
XLB-1000	Electric Blender with Paddle Controls	Set	4



Cap removed, tamper inserted



Blend fruits, ice and a variety of other ingredients

## ICE CUBE TRAYS



ICCT-4R

NEW



ICCT-8R

NEW

## ICE CUBE TRAYS

*These silicone trays make large 2" cubes of ice and keep drinks chilled longer than the typical ice cube.*

- ◆ Silicone material for easy removal
- ◆ Cubes also fit any standard Whiskey glass

ITEM	DESCRIPTION	UOM	CASE
ICCT-4R	4-Cube Tray	Each	12/72
ICCT-8R	8-Cube Tray	Each	12/72

## ICE CRUSHER



ICP-9

## MANUAL ICE CRUSHER

*Easily make coarse or fine ice chips for cool drinks, as well as ice beds for shellfish.*

ITEM	DESCRIPTION	UOM	CASE
ICP-9	6" x 4-7/8" x 9-1/2"H	Each	12

### ICE PICK

- ◆ Nickered Steel

ITEM	DESCRIPTION	UOM	CASE
ICH-1	9"L	Each	24/144



ICH-1

### ICE CHIPPER

- ◆ 6-prong nickelered steel with wooden handle

ITEM	DESCRIPTION	UOM	CASE
ICH-9	9"L	Each	12/120



ICH-9

### ICE TONGS

- ◆ Stainless Steel

ITEM	DESCRIPTION	UOM	CASE
ICT-7	Five Prong, Textured, 7"L	Each	12/144
IT-7	Three Prong, Satin Finish, 7"L	Each	12/120



ICT-7 Texture



ICT-7



IT-7

### "ICE ONLY" STORAGE CONTAINERS

- ◆ NSF listed

ITEM	DESCRIPTION	UOM	CASE
FCW-10ICE	10 Gal "Ice Only" Container	Each	6
FCW-20ICE	20 Gal "Ice Only" Container	Each	6
FCW-10L	Lid for FCW-10ICE	Each	24
FCW-20L	Lid for FCW-20ICE	Each	12

### ICE ONLY CONTAINERS



FCW-10ICE

FCW-10L

FCW-SERIES NSF

### INSULATED ICE CADDY

- ◆ Can be used inside or outdoors, in hot or humid conditions
- ◆ Drain shelf keeps ice separate from the water, greatly increasing storage time
- ◆ Polyethylene molded body is durable and light-weight, top lid slides open
- ◆ Polyurethane foam insulation effectively keeps ice cold for several days
- ◆ Recessed front handle for convenient pulling or lifting
- ◆ No assembly required; oil caster wheel bearings before use
- ◆ 125 lb capacity
- ◆ NSF listed



ITEM	DESCRIPTION	SIZE	UOM	CASE
IIC-29	Ice Caddy w/Sliding Lid	Ext Dim: 23"L x 31.5"W x 29.25"H	Set	1
IIC-C8	Caster For IIC-29	8"Dia	Each	1
IIC-C5B	Brake Caster for IIC-29	5"Dia	Each	1

### INSULATED ICE CADDY



IIC-29

IIC-SERIES NSF

POURERS



PPA-SERIES



PP-SERIES



PPR-2-SERIES



PPR-1



MEASURED POURERS

Measured pourers can reduce liquor costs up to 30% by preventing over-pouring. When used correctly, the Winware premium measured pourers provide a fast and accurate pour every time.

- ◆ Color-coded for portion control
- ◆ Also for use with juice or oils
- ◆ New and improved over previous PPOK-series

ITEM	DESCRIPTION	UOM	CASE
PPA-050	1/2 Oz, Orange Tail	Doz	25
PPA-063	5/8 Oz, Black Tail	Doz	25
PPA-075	3/4 Oz, Green Tail	Doz	25
PPA-087	7/8 Oz, Blue Tail	Doz	25
PPA-100	1 Oz, Red Tail	Doz	25
PPA-113	1-1/8 Oz, Purple Tail	Doz	25
PPA-125	1-1/4 Oz, Clear Tail	Doz	25
PPA-150	1-1/2 Oz, Yellow Tail	Doz	25
PPA-200	2 Oz, White Tail	Doz	25



SCREENED POURERS

- ◆ Screened spout keeps bugs and dirt out of bottle
- ◆ Spout is bent at the angle to achieve a perfect pour
- ◆ Available in three (3) colors

ITEM	DESCRIPTION	UOM	CASE
PP-SAM	Gemstone Amber	Doz	12/48
PP-SCL	Crystal Clear	Doz	12/48
PP-SSM	Midnight Smoke	Doz	12/48



ECONOMY FREE-FLOW POURERS

- ◆ Color-coded to help with memorization of drink recipes

ITEM	DESCRIPTION	UOM	CASE
PPR-2B	Blue	Doz	12/72
PPR-2C	Clear	Doz	12/72
PPR-2G	Green	Doz	12/72
PPR-2K	Black	Doz	12/72
PPR-2R	Red	Doz	12/72
PPR-2W	White	Doz	12/72
PPR-2Y	Yellow	Doz	12/72

FLEXIBLE PLASTIC POURER

ITEM	DESCRIPTION	UOM	CASE
PPR-1	Black	Each	12/120

**CLASSIC CHROME POURERS**

- ◆ Chrome spout
- ◆ Fast flow with plastic breather tube
- ◆ Food-grade poly-plastic cork

ITEM	DESCRIPTION	UOM	CASE
PP-C	Black Collar	Doz	12/48
PP-NC	No Collar	Doz	12/48

**CLASSIC METAL POURERS**

- ◆ Stainless steel breather tube and different pourer opening sizes provide various flow speeds
- ◆ Food-grade poly-plastic cork

ITEM	DESCRIPTION	UOM	CASE
PPM-4	Tapered Spout, Med Flow	Doz	12/48
PPM-4C	Tapered Spout with Hinged Cap, Med/Fast Flow	Doz	12/48
PPM-4G	Gooseneck Spout, Fast Flow	Doz	12/48
PPM-4J	Jet Spout, Extra Fast Flow	Doz	12/48



**POURERS**



**UNIVERSAL LIQUOR POURER COVER**

ITEM	DESCRIPTION	UOM	CASE
PC-1	Flexible Plastic	Doz	48

**UNIVERSAL LIQUOR POURER COVER**



PC-1

**CHAMPAGNE BOTTLE STOPPER**

- ◆ Keep the fizz and flavor in opened bottles
- ◆ Chrome-coated steel

ITEM	DESCRIPTION	UOM	CASE
CBS-1	1-3/8" Dia	Each	72/288

**BOTTLE STOPPERS**



CBS-1

**WINE BOTTLE STOPPERS**

- ◆ Color-coded collars to match various alcohols
- ◆ Stainless steel clip and food-grade thermoplastic cork

ITEM	DESCRIPTION	UOM	CASE
WBS-R	Red Collar	Doz	12/48
WBS-W	White Collar	Doz	12/48



WBS-SERIES

## POUR BOTTLES



PPB-SERIES



PPB-1B

PFBT-11W

### LIQUOR & JUICE MULTI-POUR SETS

◆ Six (6) color assortments; two (2) of each color per case

ITEM	DESCRIPTION	UOM	CASE
PPB-1MX	1 Qt	Case	1
PPB-2MX	2 Qt	Case	1

### LIQUOR & JUICE MULTI-POUR BOTTLES

◆ Each comes with spout & lid

ITEM	DESCRIPTION	UOM	CASE
PPB-1B	1 Qt, Brown	Each	12
PPB-1G	1 Qt, Green	Each	12
PPB-1O	1 Qt, Orange	Each	12
PPB-1R	1 Qt, Red	Each	12
PPB-1W	1 Qt, White	Each	12
PPB-1Y	1 Qt, Yellow	Each	12
PPB-2B	2 Qt, Brown	Each	12
PPB-2G	2 Qt, Green	Each	12
PPB-2O	2 Qt, Orange	Each	12
PPB-2R	2 Qt, Red	Each	12
PPB-2W	2 Qt, White	Each	12
PPB-2Y	2 Qt, Yellow	Each	12

### PLASTIC FLAIR BOTTLE

ITEM	DESCRIPTION	UOM	CASE
PFBT-11W	12-1/2"H	Each	4/24

## SYRUPS & LIQUEURS

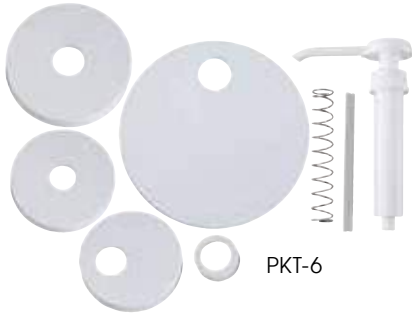

PKT-6



### PLASTIC PUMP KIT FOR SYRUP & LIQUEURS

- ◆ Use for dispensing products such as ketchup, mustard, tartar sauce, dressing, etc.
- ◆ Includes 9" standard size pump
- ◆ 5 lid sizes:
  - 1-9/16" threaded
  - 3-11/16" threaded
  - 4-1/2" threaded
  - 4-1/2" snap on
  - 6-5/16" snap on

ITEM	DESCRIPTION	UOM	CASE
PKT-6	White Pump Kit	Set	12/72

## SPEED RAILS



SPR-22D

SPR-22S

SPR-1

### BAR SPEED RAILS

- ◆ Keep the most frequently used bar liquors and drink mixes close at hand
- ◆ Stainless steel
- ◆ Mounting straps sold separately

ITEM	DESCRIPTION	UOM	CASE
SPR-22S	22" Single	Each	2/6
SPR-22D	22" Double	Each	3
SPR-32S	32" Single	Each	2/6
SPR-32D	32" Double	Each	3
SPR-42S	42" Single	Each	2/6
SPR-42D	42" Double	Each	3
SPR-1	Mounting Straps for SPR-series	Each	12/120



### 4 QT WINE BUCKETS & STAND

- ◆ Stainless steel mirror finish

ITEM	DESCRIPTION	SIZE	UOM	CASE
WB-4	4 Qt Wine Bucket, No Retail Pkg.	7.5" Dia x 8" H	Each	6/24
WB-4HV	4 Qt Deluxe Wine Bucket	8" Dia x 10" H	Each	12
WB-29S	Pipe Style Stand for WB-4 & WB-4HV	28-1/2" H	Each	6

### WINE SERVICE



WB-4

WB-4HV

WB-29S

### 8 QT WINE BUCKET & STANDS

- ◆ Stainless steel mirror finish

ITEM	DESCRIPTION	UOM	CASE
WB-8	8 Qt Wine Bucket*	Each	6/24
WB-8S	Stand for WB-8	Each	12
WB-12FS	Folding Stand for WB-8	Each	6

\*Assembly required

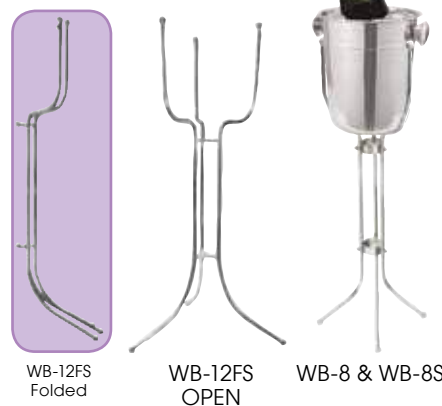

WB-12FS Folded

WB-12FS OPEN

WB-8 & WB-8S

### DOUBLE WALL WINE COASTERS

- ◆ Great space saving alternative to wine buckets
- ◆ Can also be used to display light snacks, hors d'oeuvres or desserts on tabletops
- ◆ Satin finish stainless steel
- ◆ Each measures 4-5/8" Dia x 2-5/8"H
- ◆ Fits 3-3/4" diameter wine bottles

ITEM	DESCRIPTION	UOM	CASE
DWCC-5	Smooth	Each	12
DWCC-5H	Hammered	Each	12



DWCC-5

DWCC-5H

### DOUBLE WALL ICE BUCKET

*Subtle and stylish, this double-walled stainless steel ice bucket prevents condensation and maintains interior temperatures to keep ice colder for longer time periods.*

- ◆ Stainless steel
- ◆ Ideal for hotel rooms
- ◆ Convenient carrying handle and cover

ITEM	DESCRIPTION	UOM	CASE
ICB-60	60 Oz	Each	8



ICB-60

### WINE COOLERS

ITEM	DESCRIPTION	SIZE	COLOR	UOM	CASE
WC-60	Double Wall Hourglass, Mirror S/S	6" Dia x 6" H		Each	12
WC-7M	Marble, White	5" Dia x 7" H	White	Each	6
WC-5	Double Wall, Satin S/S, No Retail Pkg.	4-1/2" Dia x 7-3/4" H		Each	6/24
WC-4A	Acrylic, Clear	4-1/2" Dia x 9-1/4" H	Clear	Each	12



WC-60

WC-7M

WC-5

WC-4A

## BAR TRAYS



STRS-16

## ROUND SERVICE TRAYS

Made of highly polished stainless steel, these round trays feature a whimsical swirl design, adding a modern flair to even the most traditional drink presentations.

ITEM	DESCRIPTION	UOM	CASE
STRS-12	12"	Each	12/48
STRS-14	14"	Each	12/24
STRS-16	16"	Each	12/24

## NON-SLIP SERVING TRAYS



### DELUXE FIBERGLASS TRAYS

- ◆ High durability fiberglass tray with self-molded peel-resistant non-slip surface
- ◆ Easy to wash by hand, however not recommended to leave soaking in hot water
- ◆ NSF listed



TFG-16N

TFG-2622K



TFG-SERIES

ITEM	DESCRIPTION	SIZE	COLOR	UOM	CASE
TFG-11K	Round	11"	Black	Each	12
TFG-11N	Round	11"	Brown	Each	12
TFG-14K	Round	14"	Black	Each	12
TFG-14N	Round	14"	Brown	Each	12
TFG-16K	Round	16"	Black	Each	12
TFG-16N	Round	16"	Brown	Each	12
TFG-2622K	Oval	26"x 22"	Black	Each	6
TFG-2622N	Oval	26"x 22"	Brown	Each	6



TRH-16

TRH-2722K



TRH-SERIES

## EASY-HOLD RUBBER-LINED PLASTIC TRAYS

- ◆ NSF listed

ITEM	DESCRIPTION	SIZE	COLOR	UOM	CASE
TRH-11	Round	11"	Brown	Each	12
TRH-11K	Round	11"	Black	Each	12
TRH-14	Round	14"	Brown	Each	12
TRH-14K	Round	14"	Black	Each	12
TRH-16	Round	16"	Brown	Each	12
TRH-16K	Round	16"	Black	Each	12
TRH-1418	Rectangular	14"x 18"	Brown	Each	12
TRH-1418K	Rectangular	14"x 18"	Black	Each	12
TRH-2722	Oval	22"x 27"	Brown	Each	6
TRH-2722K	Oval	22"x 27"	Black	Each	6

## PLASTIC CORK-LINED TRAYS

ITEM	DESCRIPTION	UOM	CASE
TCK-14	14" Round	Each	12/48
TCK-16	16" Round	Each	12/36
TCK-14CK	Replacement Cork for TCK-14	Each	50/350
TCK-16CK	Replacement Cork for TCK-16	Each	50/350



TCK-16



**MULTI-CHANNEL GLASS HANGERS**

- ◆ Chrome-plated

ITEM	DESCRIPTION	SIZE	UOM	CASE
GHC-1836	8 Channels	18" x 36" x 4"	Each	2/4
GHC-1848	11 Channels	18" x 48" x 4"	Each	2/4

**OVERHEAD GLASS RACKS**

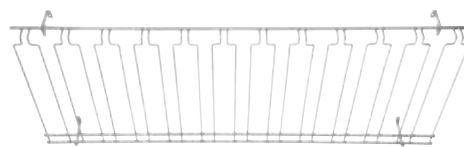

GHC-1848  
(11 CHANNELS)

**SINGLE-CHANNEL GLASS HANGERS**

ITEM	DESCRIPTION	SIZE	UOM	CASE
GH-10	Brass Plated	10"	Each	12/72
GH-16	Brass Plated	16"	Each	12/72
GH-24	Brass Plated	24"	Each	12/48
GHC-10	Chrome Plated	10"	Each	12/72
GHC-16	Chrome Plated	16"	Each	12/72
GHC-24	Chrome Plated	24"	Each	12/48

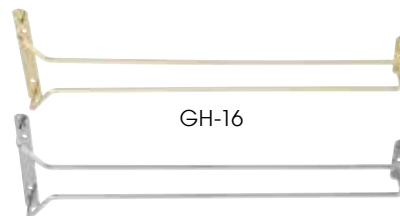

GH-16



GHC-16

**BAR LINERS**

- ◆ Roll measures 2"W x 40'L
- ◆ Available in assorted colors
- ◆ BPA-free

ITEM	DESCRIPTION	UOM	CASE
BL-240C	Clear	Roll	2
BL-240G	Green	Roll	2
BL-240K	Black	Roll	2
BL-240R	Red	Roll	2
BL-240W	White	Roll	2

**BAR LINERS & SERVICE MATS**



BL-SERIES



**BAR SERVICE MATS**

- ◆ Measures 12" x 18"

ITEM	DESCRIPTION	UOM	CASE
BM-1812B	Brown	Each	12
BM-1812K	Black	Each	12



BM-1812B



BM-1812K

**INTERLOCKING BAR MATS**

- ◆ Measures 12" x 12"
- ◆ Cuts easily to fit any counter shape
- ◆ Lightweight and dishwasher safe

ITEM	DESCRIPTION	UOM	CASE
BML-12C	Clear	Each	12/24
BML-12K	Dark Smoke	Each	12/24



BML-12C

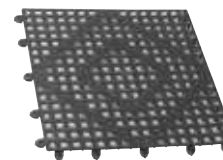

BML-12K

**BAR RAIL SPILL MATS**

- ◆ Measures 3-1/4" x 27"

ITEM	DESCRIPTION	UOM	CASE
BM-327B	Brown	Each	12/48
BM-327K	Black	Each	12/48



BM-SERIES

BAR CLEAN-UP



SAS-4

MAS-4K

MAS-4R



GWB-3

GWB-3-BR



GWB-1



BTGP-21



BTH-2028G



BTM-16AC

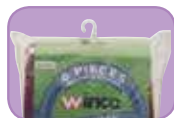

Package comes with hanging hook



BTM-16W



BTW-30



OP-7

STAINLESS STEEL ASHTRAY

ITEM	DESCRIPTION	UOM	CASE
SAS-4	4"Dia, Stackable	Each	24/96



BAKELITE ASHTRAYS

- ◆ Heat resistant up to 338°F (170°C)

ITEM	DESCRIPTION	UOM	CASE
MAS-4K	4"Dia, Black	Doz	12
MAS-4R	4"Dia, Red	Doz	12

GLASS WASHER BRUSHES

- ◆ Four (4) suction feet provide stability on slippery surfaces
- ◆ Dishwasher safe

ITEM	DESCRIPTION	UOM	CASE
GWB-3	3 Brushes with Base	Each	12
GWB-3-BR	Brush for GWB-3	Each	100



BEER MUG WASHER

*Eliminate hand-scrubbing glassware with Winco's Beer Mug Washer. The long-lasting nylon bristles are tough enough to get out grime, yet soft enough that they will not scratch or damage glass. Four suction feet hold to surfaces, preventing movement while in use.*

- ◆ Features one glass washer in the center with additional scrubbing bristles on the sides
- ◆ Wide enough to accommodate a beer mug & the handle
- ◆ Dirty water can be drained through detachable hose
- ◆ Durable plastic construction at space-saving size

ITEM	DESCRIPTION	UOM	CASE
GWB-1	Manual Mug Washer	Each	6



GLASS POLISHING TOWEL

- ◆ 100% cotton w/red pinstripes
- ◆ Lint-free and non-abrasive to eliminate streaking, yet is gentle on glassware
- ◆ Thousands of microscopic fibers pick up dirt and dust
- ◆ Absorbs seven times its weight in liquids, also ideal for countertops and tabletops

ITEM	DESCRIPTION	UOM	CASE
BTGP-21	16" x 29"	Doz	10/20



HERRINGBONE BAR TOWEL

- ◆ 100% cotton, super absorbent
- ◆ Green stripe provides easy designation of towel for specific use to prevent cross-contamination

ITEM	DESCRIPTION	UOM	CASE
BTH-2028G	20" x 28"	Doz	10/20



MICROFIBER TOWELS

- ◆ Lightweight, super absorbent and quick drying
- ◆ Multi-color pack contains white, green, yellow, brown, orange and red towels
- ◆ Dimensions: 16" x 16"
- ◆ Each pack contains six (6) towels

ITEM	DESCRIPTION	UOM	CASE
BTM-16AC	Assorted Colors	Pack	20
BTM-16W	White	Pack	20



WHITE BAR TOWEL

- ◆ 100% cotton

ITEM	DESCRIPTION	UOM	CASE
BTW-30	16" x 19"	Doz	10/20

OVERFLOW PIPES

ITEM	DESCRIPTION	UOM	CASE
OP-7	7" x 1"Dia	Each	24/288
OP-11	11" x 1"Dia	Each	12/144



# KITCHEN *Prep & Cook*



## ACERO FORGED CUTLERY



Our Acero forged series offers exceptional commercial quality at never-before-seen prices.

- ◆ Fully forged, full-tang construction
- ◆ Made of X50 Cr MoV15 German steel
- ◆ Unique POM injection molded handles help to achieve balanced weight distribution for ease of use
- ◆ 6-spot advanced polishing allows for a more comfortable grip
- ◆ Easy edge maintenance and rapid sharpening
- ◆ NSF listed

ITEM	DESCRIPTION	BLADE	UOM	CASE
KFP-30	Peeling Knife	2-3/4" L	Each	6/72
KFP-35	Paring Knife	3-1/2" L	Each	6/72
KFP-50	Utility Knife	5" L	Each	6/72
KFP-51	Tomato Knife	5" L	Each	6/72
KFP-61	Boning Knife	6" L	Each	6/36
KFP-70	Santoku Knife	7" L	Each	6/36
KFP-73	Nakiri Knife	7" L	Each	6/36

NSF KFP-SERIES

**X50 CR MOV15  
GERMAN STEEL**  
**FULLY FORGED, FULL TANG**  
**UNIQUE POM HANDLE**



# ACERO FORGED CUTLERY

## CHEF'S KNIVES

◆ NSF listed

ITEM	DESCRIPTION	BLADE	UOM	CASE
KFP-60	Chef's Knife	6" L	Each	6/36
KFP-80	Chef's Knife	8" L	Each	6/36
KFP-84	Hollow Ground	8" L	Each	6/36
KFP-100	Chef's Knife	10" L	Each	6/36
KFP-103	Hollow Ground	10" L	Each	6/36
KFP-104	Short Bolster	10" L	Each	6/36
KFP-120	Chef's Knife	12" L	Each	6/36



KFP-SERIES 

FULLY FORGED BLADE



KFP-60



KFP-80



KFP-84



KFP-100



KFP-103



KFP-104



KFP-120

**ACERO FORGED CUTLERY**

◆ NSF listed

ITEM	DESCRIPTION	BLADE	UOM	CASE
KFP-74	Fillet Knife, Flexible	7" L	Each	6/36
KFP-83	Offset Bread Knife	8" L	Each	6/36
KFP-82	Bread Knife	8" L	Each	6/36
KFP-81	Slicer	8" L	Each	6/36
KFP-101	Granton Edge Slicer	10" L	Each	6/36
KFP-102	Fish/Roast Granton Edge Slicer	10" L	Each	6/36

**ACERO FORGED CUTLERY**



**NSF** KFP-SERIES



**ACERO FORGED COOK'S FORKS**

◆ Extra heavyweight

ITEM	DESCRIPTION	LENGTH	UOM	CASE
KFP-71	11" O.L. Straight	7" Prongs	Each	6/36
KFP-121	12" O.L. Curved	8" Prongs	Each	6/36
KFP-140	14" O.L. Curved	9" Prongs	Each	6/36
KFP-180	18" O.L. Curved	9" Prongs	Each	6/36

**NSF** KFP-SERIES





ACERO FORGED CUTLERY



**ACERO KNIFE BLOCK SET**

◆ Knives included are NSF listed

ITEM	DESCRIPTION	UOM	CASE
KFP-BLKA	7-Pc Knife Block Set	Set	4

Includes:

- ◆ 3.5" Paring Knife (KFP-35)
- ◆ 5" Utility Knife (KFP-50)
- ◆ 6" Boning Knife (KFP-61)
- ◆ 8" Chef Knife (KFP-80)
- ◆ 8" Bread Knife (KFP-82)
- ◆ 8" Sharpening Steel
- ◆ Wooden Knife Block
- ◆ Bonus Shears (KS-06)



AVAILABLE IN MAY 2017

NEW

KFP-BLKA KNIVES NSF

**ACERO KNIFE KIT**

◆ Knives included are NSF listed

ITEM	DESCRIPTION	UOM	CASE
KFP-KITA	7-Pc Knife Kit	Set	6

Includes:

- ◆ 3.5" Paring Knife (KFP-35)
- ◆ 6" Boning Knife (KFP-61)
- ◆ 8" Chef Knife (KFP-80)
- ◆ 8" Bread Knife (KFP-82)
- ◆ 10" Slicer (KFP-101)
- ◆ 12" Sharpening Steel (KFP-122)
- ◆ 11-slot Knife Bag (KBG-11)
- ◆ Bonus Shears (KS-06)



KFP-KITA KNIVES NSF

**ACERO DIAMOND STEEL SHARPENERS**

*Durable and long lasting, these diamond coated steel rods sharpen knives faster than conventional stones. The extra-fine grit allows for regular honing or final polishing.*

◆ NSF listed

ITEM	DESCRIPTION	LENGTH	UOM	CASE
KFP-122	20mm Width, Oval	12"	Each	6/24
KFP-123	12mm Dia, Round	12"	Each	6/24



KFP-122



Shape of KFP-122



KFP-123

KFP-SHARPENERS NSF

# STÄL STAMPED CUTLERY



Stäl series, our most economically priced line, offers the same level of quality and performance as others costing twice as much.

- ◆ Razor-sharp X50 Cr MoV15 German steel blade
- ◆ Ergonomically designed slip-resistant, stain-free white polypropylene handles offer exceptional comfort, reducing arm and hand fatigue
- ◆ Protective finger guard
- ◆ Easy edge maintenance and rapid sharpening
- ◆ NSF listed

ITEM	DESCRIPTION	BLADE	UOM	CASE
KWP-30	Paring Knife, 2-Pcs/Pk	3-1/4" L	Pack	6/36
KWP-31	Serrated Paring Knife, 2-Pcs/Pk	3-1/2" L	Pack	6/36
KWP-50	Utility Knife, Wavy Edge	5-1/2" L	Each	6/36
KWP-63	Utility Knife, Wavy Edge	6" L	Each	6/36
KWP-60	Boning Knife, Flexible	6" L	Each	6/36
KWP-61	Boning Knife, Narrow	6" L	Each	6/36
KWP-62	Boning Knife, Wide	6" L	Each	6/36
KWP-92	Bread Knife, Offset	9" L	Each	6/36
KWP-91	Bread Knife	9-1/2" L	Each	6/36
KWP-90	Cimeter Steak Knife	9-1/2" L	Each	6/36



2PCS PER PACK

NEW



KWP-30



KWP-31



KWP-50



KWP-63



KWP-60



KWP-61



KWP-62



KWP-92



KWP-91



KWP-90

NSF KWP-SERIES

X50 CR MOV15  
GERMAN STEEL  
HIGH CARBON  
STAIN RESISTANT



**STÄL CHEF'S KNIVES**

◆ NSF listed

ITEM	DESCRIPTION	BLADE	UOM	CASE
KWP-70	Santoku	7" L	Each	6/36
KWP-80	Chef's Knife	8" L	Each	6/36
KWP-81	Hollow Ground	8" L	Each	6/36
KWP-100	Chef's Knife	10" L	Each	6/36
KWP-101	Hollow Ground	10" L	Each	6/36

**STÄL STAMPED CUTLERY**



KWP-70

KWP-80



KWP-81

KWP-100



KWP-101

KWP -SERIES



**STÄL STAMPED CUTLERY**

◆ NSF listed

ITEM	DESCRIPTION	BLADE	UOM	CASE
KWP-93	Hollow Ground Cimenter	9-1/2" L	Each	6/36
KWP-121	Slicer, Wavy Edge	12" L	Each	6/36
KWP-122	Roast Beef Slicer	12" L	Each	6/36
KWP-123	Hollow Ground Slicer	12" L	Each	6/36



KWP-93

KWP-121

KWP-122

KWP-123

KWP -SERIES





NSF KWP-COLOR SERIES

X50 CR MOV15  
GERMAN STEEL  
HIGH CARBON  
STAIN RESISTANT

SEE PG. 205  
FOR COLOR-CODED  
CUTTING BOARDS

## STÄL COLORED HANDLES



A selection of Stäl knives now come with HAACP color-coded non-slip handles for preventing cross-contamination and a variety of other uses around the kitchen.

- ◆ Razor-sharp X50 Cr MoV15 German steel blade
- ◆ Ergonomically designed slip-resistant stain-free white polypropylene handles offer exceptional comfort and reduce arm and hand fatigue
- ◆ Protective finger guard
- ◆ Easy edge maintenance and rapid sharpening
- ◆ NSF listed

HAACP STANDARD COLOR-CODING SYSTEM		
Raw Meats	Raw Poultry	Vegetable & Fruit
Bakery & Dairy	Cooked Meats	Seafood

2PCS PER  
PACK

NEW



KWP-30R



### 3-1/4" PARING KNIFE

ITEM	DESCRIPTION	UOM	CASE
KWP-30R	Red, 2-Pcs/Pk	Pack	6/36
KWP-30Y	Yellow, 2-Pcs/Pk	Pack	6/36
KWP-30G	Green, 2-Pcs/Pk	Pack	6/36
KWP-30N	Brown, 2-Pcs/Pk	Pack	6/36
KWP-30U	Blue, 2-Pcs/Pk	Pack	6/36



### 6" FLEXIBLE BONING KNIFE

ITEM	DESCRIPTION	UOM	CASE
KWP-60R	Red	Each	6/36
KWP-60Y	Yellow	Each	6/36
KWP-60G	Green	Each	6/36
KWP-60N	Brown	Each	6/36
KWP-60U	Blue	Each	6/36

NEW



KWP-60R



### 6" NARROW BONING KNIFE

ITEM	DESCRIPTION	UOM	CASE
KWP-61R	Red	Each	6/36
KWP-61Y	Yellow	Each	6/36
KWP-61G	Green	Each	6/36
KWP-61N	Brown	Each	6/36
KWP-61U	Blue	Each	6/36

NEW



KWP-61R

# STÄL COLORED HANDLES

## 7" SANTOKU KNIFE

ITEM	DESCRIPTION	UOM	CASE
KWP-70R	Red	Each	6/36
KWP-70Y	Yellow	Each	6/36
KWP-70G	Green	Each	6/36
KWP-70N	Brown	Each	6/36
KWP-70U	Blue	Each	6/36



KWP-70R



## 8" CHEF'S KNIFE

ITEM	DESCRIPTION	UOM	CASE
KWP-80R	Red	Each	6/36
KWP-80Y	Yellow	Each	6/36
KWP-80G	Green	Each	6/36
KWP-80N	Brown	Each	6/36
KWP-80U	Blue	Each	6/36



KWP-80R



## 9" OFFSET BREAD KNIFE

ITEM	DESCRIPTION	UOM	CASE
KWP-92R	Red	Each	6/36
KWP-92Y	Yellow	Each	6/36
KWP-92G	Green	Each	6/36
KWP-92N	Brown	Each	6/36
KWP-92U	Blue	Each	6/36



KWP-92R



## 10" CHEF'S KNIFE

ITEM	DESCRIPTION	UOM	CASE
KWP-100R	Red	Each	6/36
KWP-100Y	Yellow	Each	6/36
KWP-100G	Green	Each	6/36
KWP-100N	Brown	Each	6/36
KWP-100U	Blue	Each	6/36



KWP-100R



## 12" WAVY EDGE SLICER KNIFE

ITEM	DESCRIPTION	UOM	CASE
KWP-121R	Red	Each	6/36
KWP-121Y	Yellow	Each	6/36
KWP-121G	Green	Each	6/36
KWP-121N	Brown	Each	6/36
KWP-121U	Blue	Each	6/36



KWP-121R



KWP-COLOR SERIES 

## SHARPENING STEELS

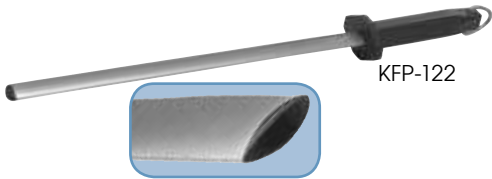

Shape of KFP-122



NSF® KFP-SHARPENERS

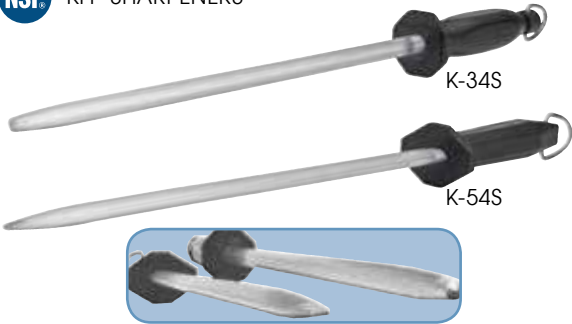

## ACERO DIAMOND STEEL SHARPENERS

Durable and long lasting, these diamond coated steel rods sharpen knives faster than conventional stones. The extra-fine grit allows for regular honing or final polishing.

◆ NSF listed

ITEM	DESCRIPTION	LENGTH	UOM	CASE
KFP-122	20mm Width, Oval	12"	Each	6/24
KFP-123	12mm Dia, Round	12"	Each	6/24

## PREMIUM SHARPENING STEELS

Made of super hard HRC59-63 steel, these magnetic sharpening steels attract metal shavings during the sharpening process to prevent debris from sticking to knives and getting onto food.

ITEM	DESCRIPTION	LENGTH	UOM	CASE
K-34S	13mm Dia, Round	14"	Each	6/24
K-54S	22mm Width, Oval	14"	Each	6/24

## SHARPENING STEELS

ITEM	DESCRIPTION	LENGTH	UOM	CASE
K-12S	Stainless Steel	12"	Each	12/48
K-14S	Stainless Steel	14"	Each	12/48

## SHARPENING TOOLS

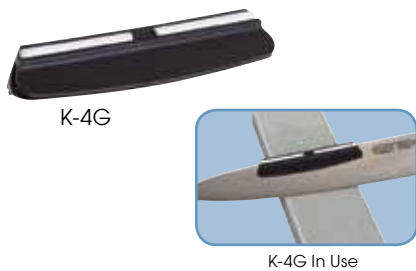
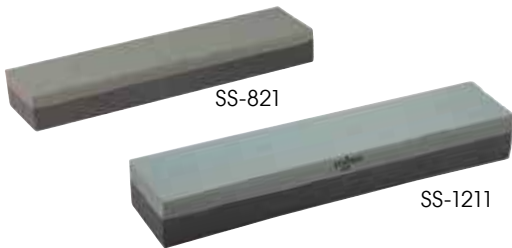

## COMBINATION SHARPENING STONE

- ◆ Top-grade carbonized silicon
- ◆ Fine and medium grain

ITEM	DESCRIPTION	UOM	CASE
SS-821	8"L x 2"W x 1"H	Each	24
SS-1211	12"L x 2-1/2"W x 1-1/2"H, No Retail Pkg.	Each	12

## SHARPENING GUIDE WITH CERAMIC INSERTS

Sharpening knives has never been easier! Sharpening guides by Winco keep knives at the optimal angle while using sharpening stones.

- ◆ Ideal sharpening angle for ultimate knife performance
- ◆ Durable plastic body with protective ceramic inserts
- ◆ For use with 6" and larger chef's knives

ITEM	DESCRIPTION	UOM	CASE
K-4G	Sharpening Guide	Each	12/144

SHARPENING TOOLS

**FOUR-STAGE KNIFE SHARPENER**

No matter if you prefer standard or Asian styled knives, Winco's Four-Stage Sharpener offers one tool to do the job. Designed for the commercial kitchen, the wide, rubberized base provides the stability for any busy chef to sharpen their favored knife.

- ◆ For either standard or Asian style knives, coarse stages quickly sharpen dull knives, while fine stages hone to a razor sharp edge
- ◆ Reduced wobbling - the safest sharpener with oversized non-slip base
- ◆ Most ergonomic handle available for comfort, slip-resistance and grip control

ITEM	DESCRIPTION	UOM	CASE
KSP-4	9-7/8"L x 2-5/8"W x 3-3/4"H	Each	12/24



**NEW**  
KSP-4

**AVAILABLE IN MAY 2017**

**DUAL-STAGE KNIFE SHARPENER**

- ◆ Soft-grip ergonomic handle with non-skid base
- ◆ Coarse carbide steel blades for sharpening and ceramic rods for honing

ITEM	DESCRIPTION	UOM	CASE
KSP-2	7-5/8"L x 2-1/2"W x 2"H	Each	12/48



KSP-2

**KITCHEN SHEARS**

ITEM	DESCRIPTION	UOM	CASE
KS-01	All purpose	Each	12/120
KS-06*	All purpose, Detachable	Each	12/72

\*Replaces former KS-04

SHEARS



KS-01

KS-06



Detachable

**POULTRY SHEARS**

ITEM	DESCRIPTION	UOM	CASE
KS-02	Soft PP Hdl	Each	12/72
KS-03	Stainless Steel	Each	10/50



KS-02

KS-03

**HERB SHEARS**

Chopping fresh herbs is now easy with these shears featuring five (5) durable stainless steel blades.

- ◆ Works well on basil, thyme, mint and more
- ◆ Ideal for cutting, chopping and mincing herbs
- ◆ Comfortable PP and TPR handles for easy grip

ITEM	DESCRIPTION	UOM	CASE
KS-05	5-Layer Blade	Each	12/72



Easily cut, chop, and mince herbs



KS-05

## PROFESSIONAL CLEAVERS

NSF® KFP-72



KC-301

NSF® KC-401



NSF® KC-501



NSF® KC-601



KC-101

KC-201R

### EXTRA HEAVY-DUTY CLEAVER

- ◆ Full tang true forged blade
- ◆ Triple riveted handle
- ◆ NSF listed

ITEM	DESCRIPTION	UOM	CASE
KFP-72	7"L x 4-3/8"W Blade	Each	6/24

\*Replaces former KC-7

### HEAVY-DUTY CLEAVER

- ◆ Wooden handle

ITEM	DESCRIPTION	UOM	CASE
KC-301	8"L x 3-1/2"W Blade	Each	6/24

### STEEL HANDLE CHINESE CLEAVERS

- ◆ NSF listed

ITEM	DESCRIPTION	UOM	CASE
KC-401	8-1/4"L x 4"W Blade	Each	12/36
KC-501	8"L x 2-1/4"W Blade	Each	10/50

### POM HANDLE CHINESE CLEAVER

- ◆ NSF listed

ITEM	DESCRIPTION	UOM	CASE
KC-601	8"L x 3-1/2"W Blade	Each	6/36

### WOODEN HANDLE CHINESE CLEAVERS

ITEM	DESCRIPTION	UOM	CASE
KC-101	8"L x 3-1/2"W Blade	Each	12/24
KC-201R	7"L x 2"W Blade	Each	12/48

## POT FORKS



KPF-612



KPF-210

## POT FORKS

ITEM	DESCRIPTION	UOM	CASE
KPF-612	12-5/8" O.L.	Each	12/120
KPF-210	21-7/8" O.L.	Each	12/72

## PARING KNIFE



NSF® K-40P

## PARING KNIFE

- ◆ PP Handle
- ◆ NSF listed

ITEM	DESCRIPTION	UOM	CASE
K-40P	3"L Blade	Each	12/360

## KNIFE STORAGE



KR-9



WMB-18



PMB-18

## STAINLESS STEEL KNIFE RACK

- ◆ Hooks onto wall

ITEM	DESCRIPTION	UOM	CASE
KR-9	7 Slots	Each	12

## MAGNETIC KNIFE BARS

ITEM	DESCRIPTION	UOM	CASE
WMB-12	12", Wooden Base	Each	36
WMB-18	18", Wooden Base	Each	24
WMB-24	24", Wooden Base	Each	24
PMB-13	13", Plastic Base	Each	36
PMB-18	18", Plastic Base	Each	36
PMB-24	24", Plastic Base	Each	24



## KNIFE BAGS

Knife bags provide safe transport and secure storage for your chef's knives. The slots are designed to accommodate knives alone or with blade guards.

## KNIFE BAGS

AVAILABLE IN  
MAY 2017

ITEM	DESCRIPTION	UOM	CASE
KBG-8	8 Slot Knife Roll	Each	30
KBG-11*	11 Slot Knife Bag	Each	12
KBG-29	29 Slot Triple-Zip Knife Bag	Each	12

\* Replaces former KBG-10



KBG-29



KBG-11



KBG-8



## STAINLESS STEEL PROTECTIVE MESH GLOVES

Made for meat processing, the rust-resistant 304L stainless steel rings that form these mesh gloves protect hands from cuts and punctures while deboning and butchering. Each glove is reversible and is fixed with a wrist strap that features a snap and cinch fastener to keep it secure.

- ◆ Light-weight and non-corrosive
- ◆ Wrist length

ITEM	DESCRIPTION	UOM	CASE
PMG-1S	Small, White Strap	Each	10/50
PMG-1M	Medium, Red Strap	Each	10/50
PMG-1L	Large, Blue Strap	Each	10/50

## PROTECTIVE GLOVES



Closure Detail



Mesh Detail



PMG-1L



## CUT-RESISTANT GLOVES

- ◆ Resistant to serrated blades and punctures during food preparation
- ◆ High density poly/glass fibers are woven into a comfortably fitted glove
- ◆ Highly elasticized fit allows for a better grip and handling

ITEM	DESCRIPTION	UOM	CASE
GCR-M	Medium	Each	12/120
GCR-L	Large	Each	12/120

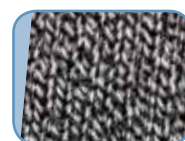

Fabric Detail



GCR-M



# SPATULAS & TURNERS

- ◆ Stainless steel, satin finish blade
- ◆ Ergonomic handle with slip-free comfort grip reduces hand fatigue
- ◆ Dishwasher safe
- ◆ NSF listed (TNH-Series)

**SAME QUALITY AS OTHERS FOR MUCH LESS**



**NEW**



DESCRIPTION	BLADE SIZE (L X W)	UOM	HIGH-HEAT ORANGE NYLON ERGO HANDLE		WOODEN HANDLE	
			ITEM	CASE	ITEM	CASE
Mini Turner	2" x 2-1/4"	* Each			TN32	12/120
Sandwich Spreader	3-5/8" x 1-1/4"	Each			TN713	12/144
Small Scraper	4-1/2" x 3-1/8"	Each			TN526	12/72
Large Scraper	4-7/8" x 4"	Each			TN54	12/72
Steak/Burger Turner	4-1/8" x 3-3/4"	* Each			TN46	12/72
Turner	8" x 4"	Each	TNH-42	12/48	TN48	12/24
Grill Spatula	4-1/4" x 2-3/16"	* Each			TN165	12/72
Teppanyaki Turner, Full Tang	4" x 3-1/2"	* Each			TN43	12/72
Pie Server	4-5/8" x 2-3/8"	* Each			TN166	12/72
Fish Spatula	6-3/4" x 3-1/4"	Each	TNH-60	12/144	FST-6	12/144
Hamburger Turner	5-1/8" x 2-7/8"	* Each	TNH-61	12/72	TN719	12/72
Extra Heavy Turner, Cutting Edge Blade	5" x 6"	* Each	TNH-63	12/48	TN56	12/48
Square Edge Turner	6-1/4" x 3"	* Each	TNH-64	12/72		
Square Edge Turner	7-1/4" x 3"	* Each	TNH-70	12/48		
Flexible Turner	8-1/4" x 2-7/8"	* Each	TNH-90	12/48	TN249	12/72
Flexible Turner (Perforated Blade)	8-1/4" x 2-7/8"	* Each	TNH-91	12/48	TN409	12/72
Offset Giant Turner	8-1/2" x 2-7/8"	* Each			TN44	12/48
Offset Spatula	3-1/2" x 3/4"	* Each			TOS-4	24/288
Offset Spatula	6-1/2" x 1-5/16"	* Each			TOS-7	12/144
Offset Spatula	8-1/2" x 1-1/2"	* Each			TOS-9	12/72
Bakery Spatula	4" x 3/4"	Each			TNS-4	24/288
Bakery Spatula	7-15/16" x 1-1/4"	Each			TNS-7	12/144
Bakery Spatula	10" x 1-3/8"	Each			TNS-9	12/72

\*Measurement reflects blade size not including offset

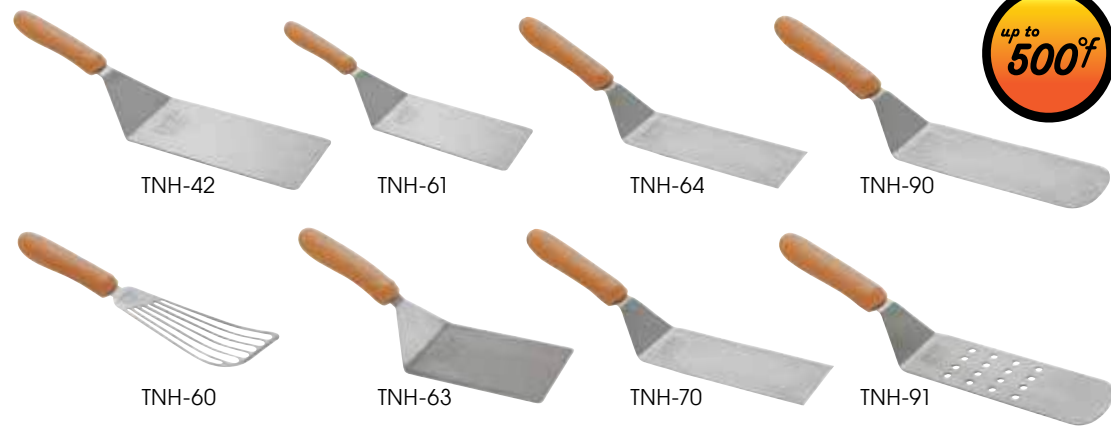

**up to 500°f**

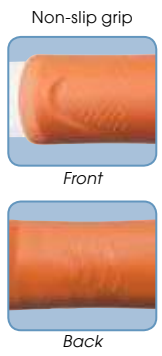

**NSF** TNH-SERIES (ORANGE)



Relative size comparisons shown

# SPATULAS & TURNERS

- ◆ Stainless steel, satin finish blade
- ◆ Ergonomic handle with slip-free comfort grip reduces hand fatigue
- ◆ Dishwasher safe
- ◆ NSF listed



TKP-SERIES (BLACK) **NSF**  
TWP-SERIES (WHITE) **NSF**

DESCRIPTION	BLADE SIZE (L X W)	UOM	BLACK ERGO HANDLE		WHITE ERGO HANDLE	
			ITEM	CASE	ITEM	CASE
Mini Turner	2" x 2-1/4"	* Each	TKP-30	12/120	TWP-30	12/120
Sandwich Spreader	3-5/8" x 1-1/4"	Each	TKP-31	12/144	TWP-31	12/144
Small Scraper	4-1/2" x 3-1/8"	Each	TKP-32	12/72	TWP-32	12/72
Large Scraper	4-7/8" x 4"	Each	TKP-40	12/120	TWP-40	12/120
Steak/Burger Turner	4-1/8" x 3-3/4"	* Each	TKP-41	12/72	TWP-41	12/72
Turner	8" x 4"	Each	TKP-42	12/48	TWP-42	12/48
Grill Spatula	4-1/4" x 2-3/16"	* Each	TKP-50	12/72	TWP-50	12/72
Pie Server	4-5/8" x 2-3/8"	* Each	TKP-51	12/72	TWP-51	12/72
Fish Spatula	6-3/4" x 3-1/4"	Each	TKP-60	12/144	TWP-60	12/144
Hamburger Turner	5-1/8" x 2-7/8"	* Each	TKP-61	12/72	TWP-61	12/72
Extra Heavy Turner, Cutting Edge Blade	5" x 6"	* Each	TKP-63	12/48		
Flexible Turner	8-1/4" x 2-7/8"	* Each	TKP-90	12/72	TWP-90	12/48
Flexible Turner (Perforated Blade)	8-1/4" x 2-7/8"	* Each	TKP-91	12/72	TWP-91	12/48
Offset Spatula	3-1/2" x 3/4"	* Each	TKPO-4	24/288	TWPO-4	24/288
Offset Spatula	6-1/2" x 1-5/16"	* Each	TKPO-7	12/144	TWPO-7	12/144
Offset Spatula	8-1/2" x 1-1/2"	* Each	TKPO-9	12/144	TWPO-9	12/144
Bakery Spatula	4" x 3/4"	Each	TKPS-4	24/288	TWPS-4	24/288
Bakery Spatula	7-15/16" x 1-1/4"	Each	TKPS-7	12/144	TWPS-7	12/144
Bakery Spatula	10" x 1-3/8"	Each	TKPS-9	12/144	TWPS-9	12/144

\*Measurement reflects blade size not including offset



Allergen Free  
SEE PAGE 207 FOR ALLERGEN-FREE PURPLE HANDLES



TKP-30



TKP-61



TKP-31



TKP-63



TKP-40



TKP-90



TKP-41



TKP-91



TKP-42



TKP-50



TKPO-9



TKP-51



TKPS-9



TKP-60

## PIZZA KNIVES & CUTTERS



NSF. KPP-18



NSF. KPP-20



PWC-4



PPC-4



VP-316



PPC-4W

NSF. PPC & VP-SERIES

### PIZZA KNIVES

- ◆ NSF listed

ITEM	DESCRIPTION	UOM	CASE
KPP-18	18" Pizza Knife	Each	6/24
KPP-20	20" Pizza Rocker Knife	Each	6/24

### PIZZA CUTTERS

- ◆ NSF listed (plastic handles)

ITEM	DESCRIPTION	BLADE	UOM	CASE
PWC-4	Wooden Handle	4" Dia	Each	12/72
PPC-2	Black PP Handle, NSF	2-1/2" Dia	Each	12/72
PPC-4	Black PP Handle, NSF	4" Dia	Each	12/72
PPC-2W	White Handle, NSF	2-1/2" Dia	Each	12/72
PPC-4W	White Handle, NSF	4" Dia	Each	12/72
VP-315	Small, Soft Grip Handle, NSF	2-1/2" Dia	Each	12/72
VP-316	Large, Soft Grip Handle, NSF	4" Dia	Each	12/72

## CHOPPING KNIVES



KCC-3



KCC-4



NSF. KCC-1



NSF. KCC-2

### MEZZALUNA KNIVES

*Effortlessly chop herbs, greens, and large vegetables. The ergonomic design with its crescent-shaped blade is the perfect prepping tool for the kitchen.*

- ◆ Rock the blade side-to-side to chop tender herbs and greens
- ◆ Use an up-and-down motion to chop larger, dense vegetables
- ◆ Ergonomic design allows you to chop effortlessly
- ◆ Durable 18/8 stainless steel

ITEM	DESCRIPTION	UOM	CASE
KCC-3	Single Blade	Each	12/72
KCC-4	Double Blade	Each	12/72

### CHOPPING KNIVES

- ◆ Use flat blade on cutting boards to chop and mince food
- ◆ Use rounded edges inside mixing bowls to cut and fold ingredients
- ◆ Dishwasher safe
- ◆ NSF listed

ITEM	DESCRIPTION	UOM	CASE
KCC-1	Single Blade	Each	6/72
KCC-2	Double Blade	Each	6/48

## OYSTER/CLAM KNIVES



NSF. VP-314



NSF. KCL-5P



KCL-1



KCL-2



KCL-3

### OYSTER/CLAM KNIVES

ITEM	DESCRIPTION	SIZE	UOM	CASE
VP-314	2-7/8" Blade, Soft Rubber Grip NSF	7-5/8" O.L.	Each	12/72
KCL-5P	3" Blade, Plastic Handle, NSF	6-3/4" O.L.	Each	12/72
KCL-1	2-3/4" Blade, Wooden Handle	5-7/8" O.L.	Each	12/72
KCL-2	2-7/8" Blade, Wooden Handle	6-5/8" O.L.	Each	12/72
KCL-3	3-1/2" Blade, Wooden Handle	7-1/2" O.L.	Each	12/72

**DOUBLE HANDLE CHEESE KNIFE**

- ◆ NSF listed

ITEM	DESCRIPTION	UOM	CASE
KCP-15	15"L, Double PP Handles	Each	6/24

**CHEESE CUTLERY**



KCP-15 NSF

**WIRE CHEESE SLICERS**

- ◆ Provides a smoother cut than cheese knives
- ◆ Wire is 44" long 18/8 stainless steel
- ◆ Customized control over slicing thickness and angle
- ◆ Easy cleanup

ITEM	DESCRIPTION	UOM	CASE
CS-44P	Polyethylene Handles	Each	24/144
CS-44W	Wooden Handles	Each	24/144



CS-44P

CS-44W

**CAST ALUMINUM CHEESE SLICER**

ITEM	DESCRIPTION	UOM	CASE
ACS-4	5" Wide Blade, S/S Wire	Each	12/36



ACS-4

**CHEESE PLANE**

- ◆ Comfortable non-slip soft-grip handle
- ◆ Dishwasher safe
- ◆ NSF listed

ITEM	DESCRIPTION	UOM	CASE
VP-309	Stainless Steel	Each	12/72



VP-309 NSF

**ERGONOMIC HANDLE CHEESE GRATERS**

- ◆ Extra strength wire frame resists bending
- ◆ Comfortable non-slip soft-grip handle
- ◆ Dishwasher safe
- ◆ NSF listed

ITEM	DESCRIPTION	UOM	CASE
VP-311	Small Holes, 1.5mm Dia	Each	12/72
VP-312	Medium Holes, 3mm Dia	Each	12/72
VP-313	Large Holes, 6mm Dia	Each	12/72



VP-311

VP-312

VP-313

VP-SERIES NSF

**STAINLESS STEEL CHEESE GRATER**

- ◆ 18/8 stainless steel rotary grater with one drum for grating fine cheeses

ITEM	DESCRIPTION	UOM	CASE
GRTS-1	8-1/4"L x 4-3/4"W x 3-3/8"H	Each	12/36



GRTS-1

**PLASTIC CHEESE GRATER**

ITEM	DESCRIPTION	UOM	CASE
PRTS-2	Cheese Grater	Each	6/24



PRTS-2

**CHEESE KNIFE SETS**

Whether it's for a wine tasting event or to accompany dessert, elegantly present and serve a full range of cheeses with these 6-piece cheese knife sets.

- ◆ Each set includes six (6) knives for hard, soft, firm, crumbly cheeses
- ◆ Stainless steel blades

ITEM	DESCRIPTION	UOM	CASE
KCS-6	6-Pc Set w/POM Hdls	Set	48
KCS-6W	6-Pc Set w/Wooden Hdls	Set	48



KCS-6



KCS-6W

STEAK KNIVES



ACERO STEAK KNIVES

With its sharp serrated edge and pointed tip, the Acero knife is designed to make simple work of cutting through steaks and chops. A stainless steel end cap provides excellent balance and control. This heavy-weight knife is a Winco exclusive and is a must-have on the tables of any steak house.



ITEM	DESCRIPTION	BLADE	UOM	CASE
SK-1	Acero Gourmet Steak Knives, 4-pc Gift Pack	5"	Pack	6
SK-12	Acero Gourmet Steak Knives, 12-pc Bulk Pack	5"	Doz	6
SK-22	Acero Gourmet Steak Knives, Round Tip	5"	Doz	6



SK-SERIES



SK-1 & 12



SK-22



KB-30W



KB-15W



K-438W



K-55W



K-45W



K-35W



K-80P



K-85P



K-60P



K-50P



WOODEN HANDLE KNIVES

ITEM	DESCRIPTION	BLADE	UOM	CASE
KB-30W	Jumbo Steak Knives, Pointed Tip	5"	Doz	12
KB-15W	Jumbo Steak Knives, Round Tip	5"	Doz	12
K-438W	Steak Knives, Pointed Tip and Handle	4-3/8"	Doz	50
K-55W	Steak Knives, Rounded Tip	4-1/2"	Doz	48
K-45W	Steak Knives, Pointed Tip	4-1/2"	Doz	48
K-35W	Economy Steak Knives, Pointed Tip	4"	Doz	48

PLASTIC HANDLE KNIVES

ITEM	DESCRIPTION	BLADE	UOM	CASE
K-80P	Jumbo Steak Knives, Round Tip, 3 Rivets	5"	Doz	25
K-85P	Jumbo Steak Knives, Round Tip, 2 Rivets, NSF	5"	Doz	12
K-60P	Steak Knives, Pointed Tip, NSF	5"	Doz	48
K-50P	Steak Knives, Round Tip, NSF	5"	Doz	48



## PREMIUM STAINLESS STEEL COOKWARE

- ◆ Commercial-quality premium stainless steel
- ◆ Tri-ply heavy-duty bottom for even heat distribution
- ◆ Extra sturdy 6-point welding on handles
- ◆ Induction ready
- ◆ NSF listed

NSF  
PREMIUM STAINLESS STEEL COOKWARE  
INDUCTION READY

### STOCK POTS WITH COVER INCLUDED

ITEM	DESCRIPTION	SIZE (DIA X HEIGHT)	UOM	CASE
SST-8	8 Qt	9-1/2" x 6-3/4"	Set	4
SST-12	12 Qt	11" x 7-1/8"	Set	4
SST-16	16 Qt	11" x 9-3/4"	Set	4
SST-20	20 Qt	11-3/4" x 10-1/4"	Set	4
SST-24	24 Qt	13-3/8" x 10-1/4"	Set	2
SST-32	32 Qt	14-1/4" x 11-3/4"	Set	2
SST-40	40 Qt	15-3/4" x 11-3/4"	Set	2
SST-60	60 Qt	17-3/4" x 14-1/4"	Set	1
SST-80	80 Qt	19-3/4" x 15-3/4"	Set	1

### SAUCE PANS WITH COVER INCLUDED

ITEM	DESCRIPTION	SIZE (DIA X HEIGHT)	UOM	CASE
SSSP-2	2 Qt	6-3/8" x 3-3/4"	Set	6
SSSP-3	3 -1/2 Qt	8" x 4-1/4"	Set	6
SSSP-4	4 -1/2 Qt	8" x 5-1/2"	Set	6
SSSP-6	6 Qt	9-1/2" x 5"	Set	6
SSSP-7	7 -1/2 Qt w/Hdl	9-1/2" x 6-1/8"	Set	2
SSSP-10	10 Qt w/Hdl	11" x 6-1/8"	Set	2

### BRAZIER WITH COVER INCLUDED

ITEM	DESCRIPTION	SIZE (DIA X HEIGHT)	UOM	CASE
SSLB-8	8 Qt, Non-NSF	11" x 5-1/8"	Set	4
SSLB-10	10 Qt, Non-NSF	11-11/16" x 5-1/2"	Set	4
SSLB-15	15 Qt	14-1/4" x 5-1/2"	Set	4
SSLB-20	20 Qt	15-3/4" x 6"	Set	4
SSLB-25	25 Qt	17-3/4" x 6"	Set	2
SSLB-30	30 Qt	19-3/4" x 6"	Set	2

### SAUTÉ PANS WITH COVER INCLUDED

ITEM	DESCRIPTION	SIZE (DIA X HEIGHT)	UOM	CASE
SSET-3	3 Qt	10" x 2-3/4"	Set	6
SSET-5	5 Qt	12-3/8" x 3-1/8"	Set	4
SSET-7	7 Qt	14" x 3-1/2"	Set	4

### OMELET PANS

ITEM	DESCRIPTION	SIZE (DIA X HEIGHT)	UOM	CASE
SSOP-8	8"	8" x 1-3/4"	Each	6
SSOP-9	9-1/2"	9-1/2" x 2"	Each	6
SSOP-11	11"	11" x 2-1/8"	Each	6
SSOP-12	12-1/2"	12-1/2" x 2-1/4"	Each	2
SSOP-14	14"	14" x 2-1/4"	Each	2

### REPLACEMENT COVERS

ITEM	UOM	CASE
SSTC-8	Each	6/12
SSTC-12	Each	6/12
SSTC-12	Each	6/12
SSTC-20	Each	6/12
SSTC-24	Each	6
SSTC-32	Each	6
SSTC-40	Each	6
SSTC-60	Each	6
SSTC-80	Each	6

### REPLACEMENT COVERS

ITEM	UOM	CASE
SSTC-2	Each	6
SSTC-8F	Each	6/12
SSTC-8F	Each	6/12
SSTC-8	Each	6/12
SSTC-8	Each	6/12
SSTC-12	Each	6/12

### REPLACEMENT COVERS

ITEM	UOM	CASE
SSTC-12	Each	6/12
SSTC-20	Each	6/12
SSTC-32	Each	6
SSTC-40	Each	6
SSTC-60	Each	6
SSTC-80	Each	6

### REPLACEMENT COVERS

ITEM	UOM	CASE
SSTC-8	Each	6/12
SSTC-20	Each	6/12
SSTC-24	Each	6

## APOLLO™ FRY PANS



FPT3-SERIES

FPT3-10

## APOLLO™ TRI-PLY FRY PANS

Made of 3 layers of metal with 18/8 stainless steel inside and induction ready stainless steel outside and a core of aluminum that evenly distributes heat through the body of the pan.

- ◆ Removable red, ergonomically designed, insulated silicone handle is heat-resistant to 450°F (230°C)
- ◆ NSF listed

ITEM	DESCRIPTION	SIZE	UOM	CASE
FPT3-7	7"	7-1/2" x 2-3/8"	Each	6
FPT3-8	8"	8-1/2" x 2-1/4"	Each	6
FPT3-10	10"	10-5/8" x 3"	Each	6
FPT3-12	12"	12-1/2" x 3-1/2"	Each	6
FPT3-14	14"	14-1/2" x 4-3/8"	Each	6

## PREMIUM STAINLESS STEEL FRY PANS



SSFP-SERIES



- ◆ Heavy-duty commercial quality premium stainless steel
- ◆ Tri-ply heavy duty bottom for even heat distribution
- ◆ Extra sturdy riveted 6-point welding on handles

### FRY PANS

- ◆ Induction ready
- ◆ NSF listed

ITEM	DESCRIPTION	SIZE	UOM	CASE
SSFP-8	8"	8" x 1-1/2"	Each	6
SSFP-9	9-1/2"	9-1/2" x 1-3/4"	Each	6
SSFP-11	11"	11" x 2"	Each	6
SSFP-12	12", Help Hdl.	12-1/2" x 2"	Each	2
SSFP-14	14", Help Hdl.	14-1/4" x 2-1/2"	Each	2

### NON-STICK FRY PANS

- ◆ Excalibur® non-stick coating
- ◆ Induction ready
- ◆ NSF listed

ITEM	DESCRIPTION	SIZE	UOM	CASE
SSFP-8NS	8"	8" x 1-1/2"	Each	6
SSFP-9NS	9-1/2"	9-1/2" x 1-3/4"	Each	6
SSFP-11NS	11"	11" x 2"	Each	6
SSFP-12NS	12", Help Hdl.	12-1/2" x 2"	Each	2
SSFP-14NS	14", Help Hdl.	14-1/4" x 2-1/2"	Each	2

### COVERS FOR STAINLESS STEEL FRY PANS

ITEM	DESCRIPTION	UOM	CASE
SSTC-8F	Cover for 8" Fry Pans	Each	6/12
SSTC-8	Cover for 9-1/2" Fry Pans	Each	6/12
SSTC-12	Cover for 10" and 11" Fry Pans	Each	6/12
SSTC-12F	Cover for 12" Fry Pans	Each	6/12
SSTC-32	Cover for 14" Fry Pans	Each	6

SEE PAGE 281 FOR INDUCTION COOKTOP



SSTC-32

## DOUBLE POT HOOK



PH-2

### DOUBLE POT HOOK

ITEM	DESCRIPTION	UOM	CASE
PH-2	Pot Hook	Each	24/240



**PREMIUM STAINLESS STEEL COOKWARE SET**

- ◆ Induction ready
- ◆ Extra heavy-weight stainless steel with double riveted handles
- ◆ Aluminum core, best for fast and even distribution of heat, is impact bonded between two layers of stainless steel, ensuring a lifetime of use
- ◆ 7-pc set consists of 1 quart covered sauce pan, 2 quart covered sauce pan, 5 quart covered dutch oven, and 9-1/2" saute pan

ITEM	DESCRIPTION	UOM	CASE
SPC-7H	7-Pc Set	Set	2



SEE PAGE 281 FOR INDUCTION COOKTOP



SPC-7H INDUCTION READY

**DOUBLE BOILERS & PERFORATED STEAMERS**

- ◆ Induction ready
- ◆ Cover included
- ◆ Stainless steel
- ◆ Tri-ply bottom

ITEM	DESCRIPTION	SIZE	UOM	CASE
SSDB-8	8 Qt Double Boiler	9-1/2" x 6-3/4" & 7-1/2"	Set	6
SSDB-12	12 Qt Double Boiler	10-1/4" x 8-1/2" & 9-3/8"	Set	6
SSDB-16	16 Qt Double Boiler	11" x 9-5/8" & 10-1/2"	Set	4
SSDB-20	20 Qt Double Boiler	11-7/8" x 10-5/8" & 11-1/2"	Set	4
SSDB-8S	8 Qt Steamer/Pasta Cooker	9-1/2" x 6-3/4" & 7-1/2"	Set	6
SSDB-12S	12 Qt Steamer/Pasta Cooker	10-1/4" x 8-1/2" & 9-3/8"	Set	6
SSDB-16S	16 Qt Steamer/Pasta Cooker	11" x 9-5/8" & 10-1/2"	Set	4
SSDB-20S	20 Qt Steamer/Pasta Cooker	11-7/8" x 10-5/8" & 11-1/2"	Set	4

**DOUBLE BOILERS & PERFORATED STEAMERS**



SSDB-20

SSDB-20S

SSDB-SERIES  
SSTC-SERIES



INDUCTION READY

**REPLACEMENT LIDS**

ITEM	DESCRIPTION	SIZE	UOM	CASE
SSTC-8	Replacement Cover for 8 Qt		Each	6/12
SSTC-10	Replacement Cover for 12 Qt		Each	6
SSTC-12	Replacement Cover for 16 Qt		Each	6/12
SSTC-20	Replacement Cover for 20 Qt		Each	6/12

**EGG POACHER SET**

*When a meal calls for perfectly poached eggs, this 4-cup set gets the job done quickly. The glass lid provides easy monitoring without the loss of heat so eggs cook uniformly.*

- ◆ Also can be used as mini-double boilers for melting butter or chocolate or steaming individual custard portions
- ◆ Set includes stainless steel sauce pan, glass cover, tray and 4 cups with cool touch handles
- ◆ Pan interior, tray and cups feature non-stick coating for easy release and cleaning
- ◆ Suitable for all stove tops, including induction
- ◆ Dishwasher safe

ITEM	DESCRIPTION	UOM	CASE
CEP-4	4-Cup Set	Set	6

**EGG POACHER SET**



CEP-4 INDUCTION READY

## SPECIALTY PANS

**NEW**



CSFP-11

INDUCTION READY

CSFP-SERIES

**MADE IN SPAIN**



**NEW**

CSPP-11

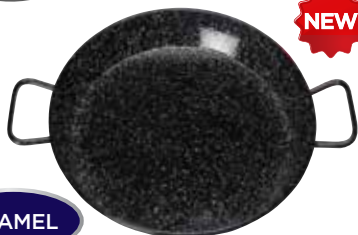

**NEW**

**ENAMEL**

CSPP-14E

**NEW**



CSPP-35



## FRENCH-STYLE FRY PANS

The Spanish-made, French-style fry pan is ideal for high-heat cooking. Well suited for long pre-heating and searing.

- ◆ High-quality carbon steel pan allows for long pre-heating at high temperatures; suitable for searing
- ◆ Riveted handle
- ◆ Made in Spain

ITEM	DESCRIPTION	UOM	CASE
CSFP-7	7-7/8"	Each	5
CSFP-8	8-5/8"	Each	8
CSFP-9	9-1/2"	Each	7
CSFP-11	10-3/8"	Each	4
CSFP-12	11-1/8"	Each	3

\*Replaces former FSFP-Series



## PAELLA PANS

These Spanish-made carbon steel pans are ideal for the creation and display of authentic paella dishes, roasting meat, making stir-fry, and much more!

ITEM	DESCRIPTION	FINISH	UOM	CASE
CSPP-7	7-7/8"	Polished	Each	12
CSPP-11	11"	Polished	Each	10
CSPP-14	14-1/8"	Polished	Each	5
CSPP-23	23-5/8"	Polished	Each	1
CSPP-35	35-1/2", 4 Hdls	Polished	Each	1
CSPP-11E	11"	Enameled	Each	10
CSPP-14E	14-1/8"	Enameled	Each	5
CSPP-23E	23-5/8"	Enameled	Each	1



## WOKS & ACCESSORIES



WOK-16W



WOK-16N Joint



WOK-36



WKCS-14



WKR-8

### CHINESE WOKS

- ◆ Stainless steel mirror finish

ITEM	DESCRIPTION	UOM	CASE
WOK-14N	14", Riveted Joint	Each	12
WOK-16N	16", Riveted Joint	Each	12
WOK-14W	14", Welded Hdl	Each	12
WOK-16W	16", Welded Hdl	Each	12

### BLACK CARBON STEEL WOKS

- ◆ Japanese style
- ◆ Integrated handle with welded joint for enhanced strength
- ◆ 1.2 mm thickness

ITEM	DESCRIPTION	UOM	CASE
WOK-34	14"	Each	12
WOK-36	16"	Each	12

### WOK COVERS

- ◆ Stainless steel mirror finish

ITEM	DESCRIPTION	UOM	CASE
WKCS-14	13-3/4"	Each	12/60
WKCS-15	15-3/8"	Each	12/48
WKCS-18	17-3/4"	Each	12/36

### WOK RING STAND

- ◆ Stainless steel

ITEM	DESCRIPTION	UOM	CASE
WKR-8	8"	Each	12/120

**DELUXE HARD ANODIZED ALUMINUM GRIDDLE**

- ◆ Great for use on all kinds of ranges
- ◆ Griddle sits right on top of range for making pancakes, bacon or scrambled eggs
- ◆ Lifted handles are silicone wrapped, preventing heat transfer

ITEM	DESCRIPTION	UOM	CASE
HAG-2012	19-5/8"L x 12-1/4"W	Each	6

**DELUXE HARD ANODIZED ALUMINUM GRIDDLE**



HAG-2012

**CAST IRON GRIDDLE**

- ◆ Reversible, flat griddle on one side, raised grill surface on the other
- ◆ Black coating

ITEM	DESCRIPTION	UOM	CASE
IGD-2095	20"L x 9-1/2"W	Each	4

**CAST-IRON COOKWARE COLLECTION**



IGD-2095

**CAST IRON SKILLETS**

- ◆ Black rust-resistant enamel coating

ITEM	DESCRIPTION	UOM	CASE
RSK-6	6-1/2"	Each	6
RSK-8	8"	Each	6
RSK-10	10"	Each	4
RSK-12	12"	Each	4



RSK-SERIES

**ROUND CAST IRON GRILL PAN**

ITEM	DESCRIPTION	UOM	CASE
IGL-10	10", Black Coating	Each	8



IGL-10

**FAJITA SERVERS**

- ◆ Improved plywood underliner resists splitting, chipping or cracking under high-heat cast iron pan

ITEM	DESCRIPTION	UOM	CASE
FS-2	Fajita Server, 2-pc Set	Set	12
FS-2-UL	Replacement Underliner for FS-2	Each	12
ISP-3	Steak Platter with Gripper, 3-Pc Set	Set	12
ISP-3-UL	Replacement Underliner for ISP-3	Each	12



FS-2

ISP-3

**MIRROR FINISH SAUCE PANS**

- ◆ Stainless steel

ITEM	DESCRIPTION	UOM	CASE
SAP-1.5	1 -1/2 Qt	Each	12/36
SAP-2	2 Qt	Each	12/36

**MIRROR SAUCE PANS**



SAP-2

**SKILLET/PAN HANDLE SLEEVES**

- ◆ Heat-resistant up to 250°F (120°C)

ITEM	DESCRIPTION	SIZE	UOM	CASE
HDH-7S	Cotton Sleeve	3-1/2" x 6-1/2"	Doz	24
HDH-6C	Chili Peppers Cotton Sleeve	3-1/2" x 6-1/2"	Doz	24

**PAN HANDLE SLEEVES**



HDH-6C



HDH-7S

## INDUCTION READY ALUMINUM COOKWARE



Induction ready pot/pan base



AFPI-10H



AFPI-SERIES



NON-STICK FRY PANS



New hybrid technology bonds a stainless steel plate to aluminum cookware, as effective in utilizing induction technology as full stainless steel cookware.

- ◆ Deep drawn 3003 Aluminum body is durable and highly conductive, better than stainless steel cookware for quickly and evenly distributing heat
- ◆ Stainless steel bonded plate allows for magnetic contact with induction cooktops
- ◆ Thicker handles and heavier rivets than standard cookware allow for secure comfort in transporting cookware
- ◆ Can also be safely used with gas or electric ranges
- ◆ NSF listed



### NATURAL FINISH INDUCTION READY ALUMINUM FRY PANS

- ◆ Ergonomic comfort handle is heat resistant to 500°F (260°C)

ITEM	DESCRIPTION	PLATE SIZE	UOM	CASE
AFPI-8H*	8"Dia	5"	Each	6
AFPI-10H	10"Dia	6-1/4"	Each	6
AFPI-12H	12"Dia	6-7/8"	Each	6

\*Compatible with all Winco® induction cookers. (May not be compatible with all induction cookers on the market.)



### NON-STICK FINISH INDUCTION READY ALUMINUM FRY PANS

- ◆ Quantum2® non-stick finish bonds to the aluminum for a long lasting, scratch-resistant finish
- ◆ Ergonomic comfort handle is heat resistant to 500°F (260°C)
- ◆ PFOA-free

ITEM	DESCRIPTION	PLATE SIZE	UOM	CASE
AFPI-8NH*	8"Dia	5"	Each	6
AFPI-10NH	10"Dia	6-1/4"	Each	6
AFPI-12NH	12"Dia	6-7/8"	Each	6

\*Compatible with all Winco® induction cookers. (May not be compatible with all induction cookers on the market.)



### INDUCTION READY STOCK POTS

- ◆ Reinforced rim adds extra durability, extending the integrity of the cookware
- ◆ 3003 Aluminum, 4.0mm, 3/16" thick

ITEM	DESCRIPTION	PLATE SIZE	UOM	CASE
AXSI-8	8 Qt	7-1/2"	Each	1
AXSI-10	10 Qt	7-1/2"	Each	1
AXSI-12	12 Qt	7-1/2"	Each	1
AXSI-16	16 Qt	7-1/2"	Each	1



### INDUCTION READY SAUTÉ PAN

- ◆ Thicker handle and heavier rivets than standard cookware allow for secure comfort when lifting and carrying
- ◆ 3003 Aluminum, 4.0mm, 3/16" thick

ITEM	DESCRIPTION	PLATE SIZE	UOM	CASE
AXTI-3	3 Qt	7-1/2"	Each	6

SEE PAGE 281 FOR INDUCTION COOKTOP



AXSI-16



AXSI-SERIES



AXTI-3



## COVERS FOR ALUMINUM FRY PANS



AXS-20C



AXS-SERIES

### COVERS FOR ALUMINUM FRY PANS

ITEM	DESCRIPTION	UOM	CASE
ASP-2C	For 8" Fry Pan	Each	12
AXS-16C	For 10" Fry Pan	Each	6
AXS-20C	For 12" Fry Pan	Each	6
AXS-40C	For 14" Fry Pan	Each	6

Constructed of 3003 series aluminum alloy with riveted heavy weight handles, the Gladiator fry pans will keep up with the rigorous demands of a commercial kitchen, in addition to providing excellent heat distribution for searing, browning and frying.

- ◆ 3.5mm thickness
- ◆ NSF listed

### GLADIATOR™ NATURAL FINISH

ITEM	DESCRIPTION	UOM	CASE
AFP-7A	7"Dia	Each	6
AFP-8A	8"Dia	Each	6
AFP-10A	10"Dia	Each	6
AFP-12A	12"Dia	Each	6
AFP-14A	14"Dia	Each	6
AFP-7A-H	7"Dia with Sleeve	Each	6
AFP-8A-H	8"Dia with Sleeve	Each	6
AFP-10A-H	10"Dia with Sleeve	Each	6
AFP-12A-H	12"Dia with Sleeve	Each	6
AFP-14A-H	14"Dia with Sleeve	Each	6

### GLADIATOR™ EXCALIBUR

- ◆ Excalibur® non-stick finish bonds to the aluminum for a long lasting, scratch-resistant finish

ITEM	DESCRIPTION	UOM	CASE
AFP-7XC	7"Dia	Each	6
AFP-8XC	8"Dia	Each	6
AFP-10XC	10"Dia	Each	6
AFP-12XC	12"Dia	Each	6
AFP-14XC	14"Dia	Each	6
AFP-7XC-H	7"Dia with Sleeve	Each	6
AFP-8XC-H	8"Dia with Sleeve	Each	6
AFP-10XC-H	10"Dia with Sleeve	Each	6
AFP-12XC-H	12"Dia with Sleeve	Each	6
AFP-14XC-H	14"Dia with Sleeve	Each	6

- ◆ Made of 3003 aluminum alloy, the Majestic™ fry pans offer exceptional performance at a great value
- ◆ Available in three finishes: Majestic™ mirror, Majestic™ natural & Majestic™ Quantum2®
- ◆ 3.5mm thickness
- ◆ NSF listed

### NATURAL FINISH ALUMINUM FRY PANS

ITEM	DESCRIPTION	UOM	CASE
AFP-7S	7"Dia	Each	6
AFP-8S	8"Dia	Each	6
AFP-10S	10"Dia	Each	6
AFP-12S	12"Dia	Each	6
AFP-14S	14"Dia	Each	6

### MIRROR FINISH ALUMINUM FRY PANS

ITEM	DESCRIPTION	UOM	CASE
AFP-7	7"Dia	Each	6
AFP-8	8"Dia	Each	6
AFP-10	10"Dia	Each	6
AFP-12	12"Dia	Each	6
AFP-14	14"Dia	Each	6

### QUANTUM2® NON-STICK ALUMINUM FRY PANS

ITEM	DESCRIPTION	UOM	CASE
AFP-7NS	7"Dia	Each	6
AFP-8NS	8"Dia	Each	6
AFP-10NS	10"Dia	Each	6
AFP-12NS	12"Dia	Each	6
AFP-14NS	14"Dia	Each	6
AFP-7NS-H	7"Dia with Sleeve	Each	6
AFP-8NS-H	8"Dia with Sleeve	Each	6
AFP-10NS-H	10"Dia with Sleeve	Each	6
AFP-12NS-H	12"Dia with Sleeve	Each	6
AFP-14NS-H	14"Dia with Sleeve	Each	6

## GLADIATOR™ FRY PANS



AFP-10A

AFP-10A-H



AFP-10XC

AFP-10XC-H

AFP-SERIES NSF

NON-STICK FRY PANS PFOA FREE

## MAJESTIC™ FRY PANS



AFP-8S

AFP-10

SEE PAGE 144 FOR REMOVABLE SLEEVES

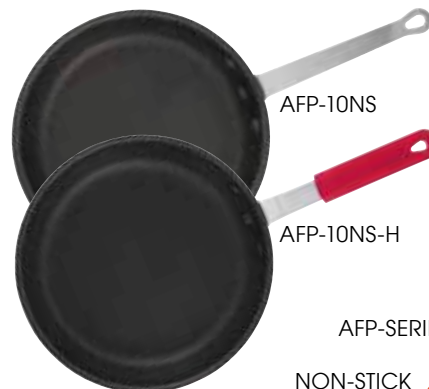

AFP-10NS

AFP-10NS-H

AFP-SERIES NSF

NON-STICK FRY PANS PFOA FREE

SEE PAGE 142  
FOR EXTRA  
LARGE SIZES



AXHB-28



AXHA-60



AXHH-40

**SUPER ALUMINUM EXTRA-HEAVYWEIGHT COOKWARE**

- ◆ 6.0 mm, 1/4" thickness
- ◆ Best quality and prices in their class
- ◆ Extra thick reinforced rim and bottom to stand up to any amount of water and usage
- ◆ Deep-drawn structure for better strength and durability
- ◆ Thicker handles make lifting and carrying heavy pots easier
- ◆ Made of 3003 aluminum - excellent for fast and even heat distribution
- ◆ NSF listed

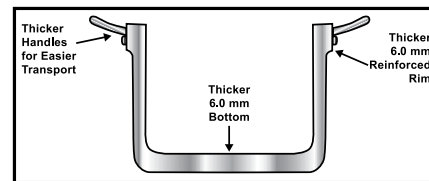

**EXTRA HEAVYWEIGHT ALUMINUM STOCK POTS**

ITEM	DESCRIPTION	SIZE (DIA X HEIGHT)	UOM	CASE
AXHH-12	12 Qt	10" x 9-1/4"	Each	1
AXHH-16	16 Qt	10" x 12"	Each	1
AXHH-20	20 Qt	12" x 10-1/2"	Each	1
AXHH-24	24 Qt	12" x 12-1/2"	Each	1
AXHH-32	32 Qt	13" x 14"	Each	1
AXHH-40	40 Qt	14" x 15"	Each	1
AXHH-60	60 Qt	16" x 17"	Each	1
AXHH-80	80 Qt	18" x 18-1/4"	Each	1

Replaces ALHP-Series

**COVERS**

ITEM	UOM	CASE
AXS-16C	Each	6
AXS-16C	Each	6
AXS-20C	Each	6
AXS-20C	Each	6
AXS-32C	Each	6
AXS-40C	Each	6
AXS-60C	Each	6
AXS-80C	Each	6

**EXTRA HEAVYWEIGHT ALUMINUM SAUCE POTS**

ITEM	DESCRIPTION	SIZE (DIA X HEIGHT)	UOM	CASE
AXHA-8	8 Qt	10" x 6-1/8"	Each	1
AXHA-14	14 Qt	12" x 7-3/4"	Each	1
AXHA-20	20 Qt	13" x 9-1/4"	Each	1
AXHA-26	26 Qt	14" x 10-1/4"	Each	1
AXHA-34	34 Qt	16" x 10-1/4"	Each	1
AXHA-40	40 Qt	16" x 11-3/4"	Each	1
AXHA-60	60 Qt	18" x 13-3/4"	Each	1

Replaces ASHP-Series

**COVERS**

ITEM	UOM	CASE
AXS-16C	Each	6
AXS-20C	Each	6
AXS-32C	Each	6
AXS-40C	Each	6
AXS-60C	Each	6
AXS-60C	Each	6
AXS-80C	Each	6

**EXTRA HEAVYWEIGHT ALUMINUM BRAZIER**

ITEM	DESCRIPTION	SIZE (DIA X HEIGHT)	UOM	CASE
AXHB-15	15 Qt	14" x 5-7/8"	Each	1
AXHB-18	18 Qt	16" x 5-13/32"	Each	1
AXHB-24	24 Qt	18" x 5-5/8"	Each	1
AXHB-28	28 Qt	18" x 6-7/16"	Each	1

Replaces ALBH-Series

**COVERS**

ITEM	UOM	CASE
AXS-40C	Each	6
AXS-60C	Each	6
AXS-80C	Each	6
AXS-80C	Each	6

SUPER ALUMINUM COOKWARE **NSF**



**SUPER ALUMINUM STANDARD WEIGHT COOKWARE**

- ◆ **4.0 mm, 3/16" thickness**
- ◆ Best quality and prices in their class
- ◆ Extra thick reinforced rim and bottom to stand up to any amount of water and usage
- ◆ Deep-drawn structure for better strength and durability
- ◆ Thicker handles make lifting and carrying heavy pots easier
- ◆ Made of 3003 aluminum - excellent for fast and even heat distribution
- ◆ NSF listed

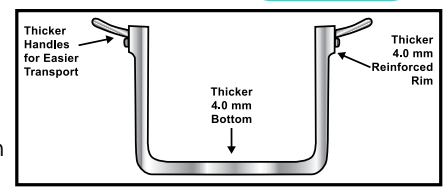

**HEAVYWEIGHT ALUMINUM STOCK POTS**

ITEM	DESCRIPTION	SIZE (DIA X HEIGHT)	UOM	CASE
AXS-8	8.5 Qt	10" x 6-1/2"	Each	1
AXS-10	10 Qt	10" x 7-1/2"	Each	1
AXS-12	12 Qt	10" x 9"	Each	1
AXS-16	16 Qt	10" x 12"	Each	1
AXS-20	20 Qt	12" x 10-1/2"	Each	1
AXS-24	24 Qt	12" x 12-1/4"	Each	1
AXS-32	32 Qt	13" x 14"	Each	1
AXS-40	40 Qt	14" x 15"	Each	1
AXS-50	50 Qt	16" x 14"	Each	1
AXS-60	60 Qt	16" x 17"	Each	1
AXS-80	80 Qt	18" x 18-1/4"	Each	1

Replaces ALST-Series

**HEAVYWEIGHT ALUMINUM SAUCE POTS**

ITEM	DESCRIPTION	SIZE (DIA X HEIGHT)	UOM	CASE
AXAP-8	8 Qt	10" x 6"	Each	1
AXAP-14	14 Qt	12" x 7-1/2"	Each	1
AXAP-20	20 Qt	13" x 9"	Each	1
AXAP-26	26 Qt	14" x 10"	Each	1
AXAP-34	34 Qt	16" x 10"	Each	1
AXAP-40	40 Qt	16" x 11-1/2"	Each	1

Replaces ASSP-Series

**HEAVYWEIGHT ALUMINUM BRAZIERS**

ITEM	DESCRIPTION	SIZE (DIA X HEIGHT)	UOM	CASE
AXBZ-15	15 Qt	14-3/8" x 5-3/4"	Each	1
AXBZ-18	18 Qt	16-3/8" x 5-1/2"	Each	1
AXBZ-24	24 Qt	18-3/8" x 5-3/4"	Each	1
AXBZ-28	28 Qt	18-3/8" x 6-1/2"	Each	1

Replaces ALB-Series

**HEAVYWEIGHT ALUMINUM SAUTE PANS (NON-NSF)**

ITEM	DESCRIPTION	SIZE	UOM	CASE
AXST-3	3 Qt	10" x 2-1/2"	Each	6
AXST-5	5 Qt	12-1/2" x 2-1/2"	Each	6
AXST-7	7-1/2 Qt	14-1/2" x 2-3/4"	Each	6

**COVERS**

ITEM	UOM	CASE
AXS-16C	Each	6
AXS-16C	Each	6
AXS-16C	Each	6
AXS-16C	Each	6
AXS-20C	Each	6
AXS-20C	Each	6
AXS-32C	Each	6
AXS-40C	Each	6
AXS-60C	Each	6
AXS-60C	Each	6
AXS-80C	Each	6

**COVERS**

ITEM	UOM	CASE
AXS-16C	Each	6
AXS-20C	Each	6
AXS-32C	Each	6
AXS-40C	Each	6
AXS-60C	Each	6
AXS-60C	Each	6

**COVERS**

ITEM	UOM	CASE
AXS-40C	Each	6
AXS-60C	Each	6
AXS-80C	Each	6
AXS-80C	Each	6

**COVERS**

ITEM	UOM	CASE
AXS-16C	Each	6
AXS-20C	Each	6
AXS-40C	Each	6

## PRECISION ALUMINUM COOKWARE



ALHP-120



ALHP-120H



ALBH-35

**NSF** PRECISION ALUMINUM COOKWARE

- ◆ 6.0 mm, 1/4" thickness
- ◆ NSF listed, reinforced rim, superior strength and durability

### EXTRA HEAVYWEIGHT ALUMINUM STOCK POTS

ITEM	DESCRIPTION	SIZE (DIA X HEIGHT)	UOM	CASE
ALHP-100	100 Qt	20" x 17.7"	Each	1
ALHP-120	120 Qt	21.7" x 19.5"	Each	1
ALHP-140	140 Qt	22.8" x 20.3"	Each	1
ALHP-160	160 Qt	22.8" x 23.2"	Each	1
ALHP-120H	120 Qt, 4 Hdls	21.7" x 19.5"	Each	1
ALHP-140H	140 Qt, 4 Hdls	22.8" x 20.3"	Each	1
ALHP-160H	160 Qt, 4 Hdls	22.8" x 23.2"	Each	1

### EXTRA HEAVYWEIGHT ALUMINUM BRAZIER

ITEM	DESCRIPTION	SIZE (DIA X HEIGHT)	UOM	CASE
ALBH-35	35 Qt	21.7" x 6"	Each	1
ALBH-40	40 Qt	22.8" x 6"	Each	1

## WINWARE ALUMINUM COOKWARE



ALST-100



ALB-40

ASET-7



**NSF** WINWARE ALUMINUM COOKWARE

- ◆ 4.0 mm, 3/16" thickness
- ◆ NSF listed, reinforced rim, strong and durable

### WINWARE HEAVYWEIGHT ALUMINUM STOCK POT

ITEM	DESCRIPTION	SIZE (DIA X HEIGHT)	UOM	CASE
ALST-100	100 Qt	20" x 17.7"	Each	1

### HEAVYWEIGHT ALUMINUM BRAZIER

ITEM	DESCRIPTION	SIZE (DIA X HEIGHT)	UOM	CASE
ALB-35	35 Qt	21.7" x 6"	Each	1
ALB-40	40 Qt	22.8" x 6"	Each	1

### HEAVYWEIGHT ALUMINUM SAUTÉ PANS

ITEM	DESCRIPTION	SIZE (DIA X HEIGHT)	UOM	CASE
ASET-3	3 Qt	9.8" x 2.6"	Each	1
ASET-5	5 Qt	11.8" x 2.6"	Each	1
ASET-7	7.5 Qt	13.8" x 2.7"	Each	1

## ALUMINUM COVERS



AXS-40C

### COVERS

ITEM	DESCRIPTION	UOM	CASE
ALPC-100	Fits ALHP-100, ALST-100	Each	6
ALPC-120	Fits ALHP-120/120H, ALBH-35, ALB-35	Each	6
ALPC-140	Fits ALHP-140/140H/160/160H, ALBH-40, ALB-40	Each	6
AXS-16C	Fits ASET-3	Each	6
AXS-20C	Fits ASET-5	Each	6
AXS-40C	Fits ASET-7	Each	6



### DOUBLE ROASTER COMBINATION

◆ Heavy-duty 10 gauge aluminum

ITEM	DESCRIPTION	SIZE	UOM	CASE
ALRP-1824	Roaster with Straps	24"L x 18"W x 4-1/2"H	Each	2
ALRP-1824L	Roaster with Straps & Lugs	24"L x 18"W x 4-1/2"H	Each	2

## ALUMINUM ROASTING PANS

REINFORCED, IMPROVED FINISH



ALRP-1824



ALRP-1824L

### BAKE/ROAST PANS

◆ Heavy-duty 12 gauge aluminum

ITEM	DESCRIPTION	SIZE	UOM	CASE
ALRP-1826	Pan without Handles	25-3/4"L x 17-3/4"W x 2-1/4"H	Each	3
ALRP-1826H	Pan with Handles	25-3/4"L x 17-3/4"W x 3-1/2"H	Each	3



ALRP-1826



ALRP-1826H



ALBP-1218

### BAKE/ROAST PAN

◆ Aluminum

ITEM	DESCRIPTION	SIZE	UOM	CASE
ALBP-1218	Pan with Handles	17-3/4"L x 11-1/2"W x 2-1/4"H	Each	6/24

### HEAVY-DUTY ALUMINUM SHEET PANS

Reinforced with galvanized wire, count on Winco® sheet pans to hold their shape in high-heat oven temperatures during baking, roasting or broiling.

- ◆ Closed bead with galvanized wire for rust resistance and reinforcement
- ◆ Made of 3003 aluminum

ITEM	DESCRIPTION	SIZE	GAUGE	UOM	CASE
ALXP-0609	1/8-Size Open Bead	6" x 9"	16	Each	24
ALXP-1310H	1/4-Size Closed Bead	10" x 13"	18	Each	24
ALXP-1813H	1/2-Size Closed Bead	13" x 18"	18	Each	12
ALXP-2216H	2/3-Size Closed Bead	16" x 22"	18	Each	12
ALXP-2618H	Full-Size Closed Bead	18" x 26"	16	Each	12



ALXP-2216H

NEW HEAVY GAUGES

SEE PAGE 160 FOR OTHER SHEET PANS



Closed bead

## HEAVY-DUTY ALUMINUM SAUCE PANS



ASP-5

ASP-5C

**NSF** ASP-SERIES



### NATURAL FINISH

- ◆ 3003 Aluminum, 3.0mm thickness
- ◆ NSF listed

ITEM	DESCRIPTION	SIZE (DIA X H)	UOM	CASE
ASP-1	1-1/2 Qt	5-3/4" x 2-3/4"	Each	12
ASP-2	2-1/2 Qt	7-3/4" x 4-1/4"	Each	12
ASP-3	3-3/4 Qt	9" x 4-2/5"	Each	12
ASP-4	4-1/4 Qt	9" x 4-1/2"	Each	12
ASP-5	5 Qt	9-3/4" x 5-1/4"	Each	12
ASP-7	7 Qt, Help Hdl	10-1/2" x 5-3/4"	Each	6
ASP-10	10 Qt, Help Hdl	11-1/2" x 5-3/4"	Each	6

### COVERS FOR ALUMINUM SAUCE PANS

- ◆ NSF listed

ITEM	DESCRIPTION	UOM	CASE
ASP-1C	Cover for 1-1/2 Qt	Each	12
ASP-2C	Cover for 2-1/2 Qt	Each	12
ASP-3C	Cover for 3-3/4 Qt	Each	12
ASP-4C	Cover for 4-1/4 Qt	Each	12
ASP-5C	Cover for 5 Qt	Each	12
ASP-7C	Cover for 7 Qt	Each	12
ASP-10C	Cover for 10 Qt	Each	12

## ALUMINUM STIR FRY PANS



ASFP-11



ASFP-11NS



**NSF** ASFP-SERIES



### ALUMINUM STIR FRY PANS

- ◆ 3003 Aluminum, 4.0mm thickness
- ◆ Ergonomic, heat-resistant silicone handle
- ◆ NSF listed

ITEM	DESCRIPTION	SIZE (DIA X H)	UOM	CASE
ASFP-11	Natural Finish	11" x 3-5/8"	Each	6
ASFP-11NS	Non-stick, Quantum2 <sup>®</sup> Coating	11" x 3-5/8"	Each	6

## COOKWARE ACCESSORIES



PH-811W



AFP-HR-SERIES



AFP-HX-SERIES



SEE PAGE 207 FOR MORE OF THE ALLERGEN-FREE LINE



AFP-10HP



### PAN GRABBER

- ◆ Heat-resistant up to 400°F (205°C)

ITEM	DESCRIPTION	SIZE (L X W)	UOM	CASE
PH-811W	Terry Cloth	11" x 8"	Doz	15

### REMOVABLE SILICONE SLEEVES FOR FRY & SAUCE PANS

- ◆ Heat-resistant up to 450°F (230°C)

ITEM	DESCRIPTION	UOM	CASE
AFP-1HR	Red, For 7" & 8"; ASP-1, 2, 3	Each	12/120
AFP-10HR	Red, For 10"	Each	12/120
AFP-2HR	Red, For 12"; ASP-4, 5, 7, 10; AXST-3; ASET-3, 5	Each	12/120
AFP-3HR	Red, For 14"; AXST-5, 7; ASET-7	Each	12/120
AFP-1HX	Blue, For 7" & 8"; ASP-1, 2, 3	Each	120
AFP-2HX	Blue, For 10" & 12"; ASP-4, 5, 7, 10; AXST-3; ASET-3, 5	Each	12/120
AFP-3HX	Blue, For 14"; AXST-5, 7; ASET-7	Each	120

### ALLERGEN-FREE SILICONE SLEEVE

ITEM	DESCRIPTION	UOM	CASE
AFP-10HP	Purple Sleeve for AFP-10 Series	Each	120

### PASTA COOKER SET

- ◆ Heavyweight 3003 aluminum pot, 3.5mm
- ◆ Includes 4 stainless steel inserts, 0.7mm thick
- ◆ Handles are heat-resistant up to 500°F (260°C)

ITEM	DESCRIPTION	UOM	CASE
APS-20	20 Qt Pasta Cooker Set	Set	1
APS-INS	Quarter-Size S/S Inset	Each	4
APS-PT	Replacement Pot	Each	1

### PASTA COOKER SET



APS-20

### ALUMINUM STEAMER BASKETS

ITEM	DESCRIPTION	UOM	CASE
ALSB-20	20 Qt Fits ALST-20, ALHP-20, AXHH-20, & AXS-20	Each	1
ALSB-32	32 Qt Fits ALST-32, ALHP-32, AXHH-32, & AXS-32	Each	1
ALSB-40	40 Qt Fits ALST-40, ALHP-40, AXHH-40, & AXS-40	Each	1
ALSB-60	60 Qt Fits ALST-60, ALHP-60, AXHH-60, & AXS-60	Each	1
ALSB-80	80 Qt Fits ALST-80, ALHP-80, AXHH-80, & AXS-80	Each	1

### ALUMINUM STEAMER BASKETS



ALSB-32

- ◆ Excellent for even heat distribution at lower temperatures
- ◆ Reinforced rim and riveted handle for optimum durability
- ◆ Includes cover

### STEAMER SETS

- ◆ Steamer sets are perfect for vegetables or pastas

ITEM	DESCRIPTION	SIZE (L X W X H)	UOM	CASE
ALDB-8S	8 Qt Set	10-3/8" x 8-5/8" x 7-1/2"	Set	1
ALDB-12S	12 Qt Set	11-1/4" x 9-5/8" x 9-1/4"	Set	1
ALDB-16S	16 Qt Set	12-5/16" x 9-1/2" x 10"	Set	1
ALDB-20S	20 Qt Set	13-1/8" x 10-1/8" x 11"	Set	1

### ALUMINUM DOUBLE BOILER & STEAMER SETS



ALDB-20S

### DOUBLE BOILER SETS

- ◆ Ideal for preparing delicate sauces, or melting chocolate and caramel
- ◆ NSF listed

ITEM	DESCRIPTION	SIZE (L X W X H)	UOM	CASE
ALDB-8	8 Qt Set	10-3/8" x 8-5/8" x 7-1/2"	Set	1
ALDB-12	12 Qt Set	11-1/4" x 9-5/8" x 9-1/4"	Set	1
ALDB-16	16 Qt Set	12-5/16" x 9-1/2" x 10"	Set	1
ALDB-20	20 Qt Set	13-1/8" x 10-1/8" x 11"	Set	1



ALDB-12

DOUBLE BOILERS 

PASTA BASKETS



MPSP-69

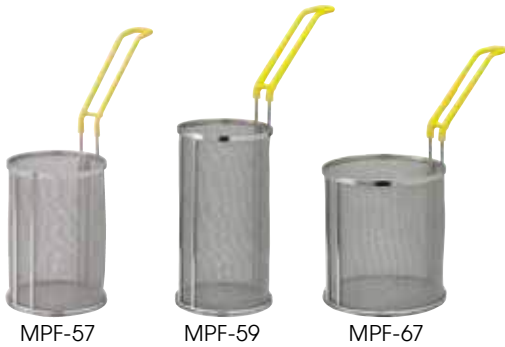

MPF-57

MPF-59

MPF-67

The Connoisseur premium pasta baskets are made of 18/8 stainless steel that is electro-polished for added corrosion resistance. The extra-heavyweight construction stands up to the constant knocking of its edges when removing pasta. The cylindrical design allows water to flow freely for even cooking and the ergonomic handle is comfortable and has an open end for hang drying. The baskets can be used with most pasta cooker machines and standard stock pots.



SINGLE PLY PERFORATED PASTA BASKET

- ◆ Designed for all pasta types
- ◆ Perforated 18/8 stainless steel, extra-heavyweight
- ◆ Durable frame can handle extra-tough commercial kitchen use

ITEM	DESCRIPTION	UOM	CASE
MPSP-69	6-1/2"Dia x 9"H, Tall	Each	8



SUPER FINE MESH PASTA BASKETS

- ◆ 18/8 stainless steel, with reinforced frame
- ◆ Designed specifically for fine pasta, such as capellini and linguine

ITEM	DESCRIPTION	UOM	CASE
MPF-57	5"Dia x 7"H, Short	Each	8
MPF-59	5"Dia x 9"H, Tall	Each	8
MPF-67	6-1/2"Dia x 7"H, Wide	Each	8

PASTA BOIL BASKETS

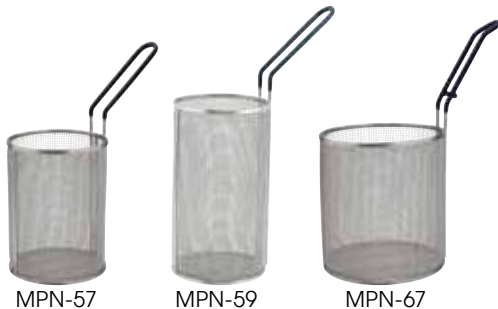

MPN-57

MPN-59

MPN-67

PASTA BOIL BASKETS

- ◆ 18/8 stainless steel frame and normal mesh makes it ideal for cooking capellini
- ◆ Fits standard pasta cookers and stock pots

ITEM	DESCRIPTION	UOM	CASE
MPN-57	5-1/4" Dia x 7"H, Short	Each	2/8
MPN-59	5" Dia x 9"H, Tall	Each	2/8
MPN-67	6-1/2" Dia x 7"H, Wide	Each	2/6

BULK PASTA BASKET

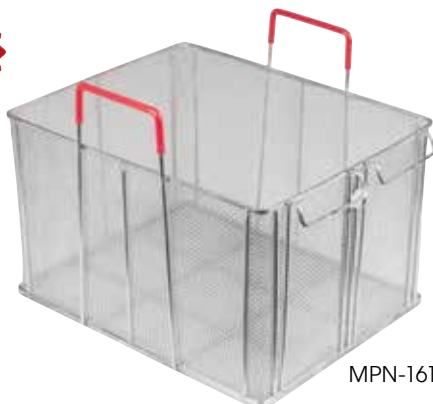

MPN-1613

BULK PASTA/IMMERSION BASKET

- ◆ Durable 18/8 stainless steel
- ◆ Plastic coated handles rated for temperatures up to 250°F (120°C)
- ◆ Suitable for cooking all types of pasta in bulk
- ◆ Fits standard cookers



ITEM	DESCRIPTION	UOM	CASE
MPN-1613	16-1/4"L x 12-7/8"W x 10"H	Each	2



### FRY BASKETS

- ◆ One piece construction, non-welded structure
- ◆ Long lasting frame
- ◆ Heavy gauge wire handle coated with high-temperature resistant colored plastic
- ◆ Nickel plated

ITEM	DESCRIPTION	COLOR	UOM	CASE
FB-10	12-1/8" x 6-1/2" x 5-3/8", 10" Hdl	Orange	Each	6
FB-20	13-1/4" x 5-5/8" x 5-5/8", 10" Hdl	Blue	Each	6
FB-30	13-1/4" x 6-1/2" x 5-7/8", 10"Hdl	Green	Each	6
FB-40	17" x 8-1/4" x 6", 12" Handle	Yellow	Each	6
FB-PS	Press with 11" Plastic Hdl, Fits FB-30	Red	Each	20
FB-PB	Press with 11" Plastic Hdl, Fits FB-10 & FB-20	Red	Each	20

### TACO & TOSTADA BASKETS

- ◆ Nickel plated

ITEM	DESCRIPTION	UOM	CASE
TB-8	Taco Basket, Eight 6" Taco Shells	Each	8
TB-18	Tostada Basket, Eighteen 6" Tostada Shells	Each	8
TB-20	18" Round Taco Salad Bowl	Each	12
TB-22	18" Triangle Taco Salad Bowl	Each	12

### FRENCH FRY BAGGERS

ITEM	DESCRIPTION	UOM	CASE
FFB-1R	Right Handle	Each	12/36
FFB-2	Dual Handles	Each	12/36

### FRYER FILTER STAND & FILTER

- ◆ Cloth filters are heat resistant up to 392°F (200°C)

ITEM	DESCRIPTION	UOM	CASE
FF-10	10" Fryer Filter Stand	Each	20
FF-RC	Rayon Cloth Filter Cones (10-Pcs/ Box)	Box	60

### FRY BASKETS



### FRYER ACCESSORIES



Using a small, round mesh basket along with a fryer/pasta pan is an ideal solution for a small kitchen where a dedicated deep fryer may not be possible.

### ROUND 6 MESH WIRE FRY BASKETS

- ◆ Nickel plated
- ◆ 1/8" mesh

ITEM	DESCRIPTION	HANDLE	UOM	CASE
FBRS-8	8-1/2"Dia x 4-1/4"H	7-1/4"	Each	20
FBRS-9	9-1/2"Dia x 5-3/4"H	7-1/4"	Each	20
FBRS-11	10-1/2"Dia x 6"H	9"	Each	20

### ROUND 4 MESH WIRE FRY BASKETS

- ◆ Nickel plated
- ◆ 1/4" mesh

ITEM	DESCRIPTION	HANDLE	UOM	CASE
FBR-8	8-1/2"Dia x 4-1/4"H	7-1/2"	Each	20
FBR-9	9-1/2"Dia x 5-3/4"H	8"	Each	20
FBR-11	10-1/2"Dia x 6"H	9"	Each	20

### FRYER PANS

- ◆ Hook-on fry pan keeps fry basket secure
- ◆ Fry basket sold separately
- ◆ Aluminum

ITEM	DESCRIPTION	SIZE	UOM	CASE
ALSP-5	5.5 Qt	10"Dia x 5"H	Each	6
ALSP-7	7 Qt	10-7/8"Dia x 5-3/4"H	Each	6
ALSP-10	10 Qt	12"Dia x 6-1/4"H	Each	6

### FRYER/PASTA COMBINATION PANS



STEAM TABLE PANS, STAINLESS STEEL

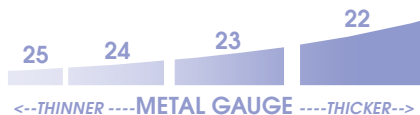

- ◆ Winco® offers the most complete collection of steam table pans in the industry
- ◆ Anti-jamming pans available in all gauges, straight sided pans available in standard weight
- ◆ Every gauge weight is made of 18/8 stainless steel
- ◆ NSF listed

NSF STEAM TABLE PANS

HEAVYWEIGHT

TRUE 24 GAUGE ANTI-JAMMING

TRUE 23 GAUGE ANTI-JAMMING

TRUE 22 GAUGE ANTI-JAMMING

SIZE	DEPTH	UOM	CASE	ITEM	ITEM	ITEM
Full-Size 20-3/4" x 12-3/4"	2-1/2"	Each	6/12	SPJM-102	SPJP-102	SPJH-102
	4"	Each	6/12	SPJM-104	SPJP-104	SPJH-104
	6"	Each	6/12	SPJM-106	SPJP-106	SPJH-106
Half-Size 10-3/8" x 12-3/4"	2-1/2"	Each	12/24	SPJM-202	SPJP-202	SPJH-202
	4"	Each	6/24	SPJM-204	SPJP-204	SPJH-204
	6"	Each	6/12	SPJM-206	SPJP-206	SPJH-206
Third-Size 6-7/8" x 12-3/4"	2-1/2"	Each	12/48	SPJM-302	SPJP-302	SPJH-302
	4"	Each	12/24	SPJM-304	SPJP-304	SPJH-304
	6"	Each	12/24	SPJM-306	SPJP-306	SPJH-306
Quarter-Size 10-5/6" x 6-5/16"	2-1/2"	Each	12/72	SPJM-402	SPJP-402	SPJH-402
	4"	Each	12/48	SPJM-404	SPJP-404	SPJH-404
	6"	Each	12/24	SPJM-406	SPJP-406	SPJH-406
Sixth-Size 6-7/8" x 6-5/16"	2-1/2"	Each	12/72	SPJM-602	SPJP-602	SPJH-602
	4"	Each	12/48	SPJM-604	SPJP-604	SPJH-604
	6"	Each	12/48	SPJM-606	SPJP-606	SPJH-606
Ninth-Size 6-3/4" x 4-1/4"	2-1/2"	Each	12/72	SPJM-902	SPJP-902	SPJH-902
	4"	Each	12/72	SPJM-904	SPJP-904	SPJH-904
	6"	Each	12/24			SPJH-906GN

NEW SIZE



NSF SPJH-906GN

WINCO® EXCLUSIVE SIZE

ADD 30% MORE COUNTER CAPACITY!

STANDARD WEIGHT

25 GAUGE STRAIGHT-SIDED

25 GAUGE ANTI-JAMMING

SIZE	DEPTH	UOM	CASE	ITEM	ITEM
Full-Size 20-3/4" x 12-3/4"	2-1/2"	Each	6/12	SPF2	SPJL-102
	4"	Each	6/12	SPF4	SPJL-104
	6"	Each	6/12	SPF6	SPJL-106
Half-Size 10-3/8" x 12-3/4"	2-1/2"	Each	12/24	SPH2	SPJL-202
	4"	Each	6/24	SPH4	SPJL-204
	6"	Each	6/12	SPH6	SPJL-206
Third-Size 6-7/8" x 12-3/4"	2-1/2"	Each	12/48	SPT2	SPJL-302
	4"	Each	12/24	SPT4	SPJL-304
	6"	Each	12/24	SPT6	SPJL-306
Quarter-Size 10-5/6" x 6-5/16"	2-1/2"	Each	12/72	SPQ2	SPJL-402
	4"	Each	12/48	SPQ4	SPJL-404
	6"	Each	12/24	SPQ6	SPJL-406
Sixth-Size 6-7/8" x 6-5/16"	2-1/2"	Each	12/72	SPS2	SPJL-602
	4"	Each	12/48	SPS4	SPJL-604
	6"	Each	12/48	SPS6	SPJL-606
Ninth-Size 6-3/4" x 4-1/4"	2-1/2"	Each	12/72	SPN2	SPJL-902
	4"	Each	12/72	SPN4	SPJL-904

SPECIALTY SIZES 25 GAUGE

SIZE	DEPTH	CASE	UOM	ITEM
Full-Size 20-3/4" x 12-3/4"	1-1/4"	6/12	Each	SPF1
	1-1/4"	12/24	Each	SPH1
Two-Third Size 14" x 12-7/8"	2-1/2"	12/24	Each	SPTT2
	4"	6/24	Each	SPTT4
	6"	6/12	Each	SPTT6

SPECIALTY SIZES 22 GAUGE

SIZE	DEPTH	CASE	UOM	ITEM
Eighteenth-Size	2"	24/96	Each	SPJH-1802



### GET-A-GRIP CHAFING DISH PANS

- ◆ Built-in handles make to avoid steam burns in transporting
- ◆ Excellent for catering, schools or buffets
- ◆ Stainless steel, patented pan and handles
- ◆ NSF listed

ITEM	DESCRIPTION	UOM	CASE
SPF2-HD	Full-Size Pan	Each	6

### SPECIALTY PANS



Patented Handle System



SPF2-HD NSF

### PERFORATED STEAM PANS

- ◆ 25 gauge, stainless steel
- ◆ NSF listed

ITEM	DESCRIPTION	UOM	CASE
SPFP2	Full-Size 2-1/2" Perf	Each	6/12
SPFP4	Full-Size 4" Perf	Each	6/12
SPFP6	Full-Size 6" Perf	Each	6/12
SPHP2	Half-Size 2-1/2" Perf	Each	6/24
SPHP4	Half-Size 4" Perf	Each	6/24
SPHP6	Half-Size 6" Perf	Each	6/12



SPFP6

SPFP-SERIES NSF

### HALF-LONG SIZE PANS & COVERS

- ◆ 25 gauge, stainless steel and anti-jamming
- ◆ NSF listed

ITEM	DESCRIPTION	UOM	CASE
SPJL-2HL	2-1/2" Half-Long Size Pan	Each	6/24
SPJL-4HL	4" Half-Long Size Pan	Each	6/24
SPJL-6HL	6" Half-Long Size Pan	Each	6/12
SPJL-HCN	Half-Long Cover, Notched	Each	12/24
SPJL-HCS	Half-Long Cover, Solid	Each	12/24



SPJL-6HL

SPJL-SERIES NSF

### DIVIDED FOOD PANS

- ◆ Stainless steel
- ◆ NSF listed

ITEM	DESCRIPTION	UOM	CASE
SPFD2	Full-Size 2-1/2"	Each	6/12
SPFD-2R	Round, fits 103A, 103B, 602 and 308A chafers	Each	10



SPFD-2R



SPFD2 NSF

### WATER & SPILLAGE PANS

- ◆ Stainless steel
- ◆ NSF listed

ITEM	DESCRIPTION	UOM	CASE
C-WPF	Full-Size Dripless Water Pan, 4" Depth, Flat Edge	Each	6
C-WPF6	Full-Size Spillage Pan, 6" Depth, Upright Standing Edge	Each	5/10
C-WPP	Full-Size Spillage Pan, 6" Depth, Flat Edge	Each	6/12

### WATER & SPILLAGE PANS



C-WPF



C-WPP



Flat edge



Upright standing edge



C-WPF6

C-WP-SERIES NSF

### ANGLED DISPLAY ADAPTOR

Add some dimension to a buffet with an angled display adaptor to give steam table pans a lift so guests can have better visibility and easier access to food.

ITEM	DESCRIPTION	UOM	CASE
ADB-4	Full-Size, S/S	Each	2/6

### ANGLED DISPLAY ADAPTOR

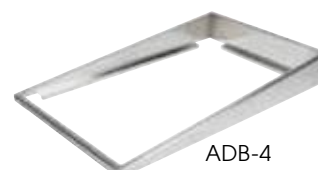

ADB-4

## ROLL-TOP COVER



C-RCF

SEE PAGE 148 FOR FOOD PAN

## ROLL-TOP COVER

- ◆ 18/8 satin finish stainless steel
- ◆ Fits full-size 12" x 20" food well opening
- ◆ Easy access hinged cover
- ◆ Plastic handle is heat resistant up to 220°F (105°C)

ITEM	DESCRIPTION	UOM	CASE
C-RCF	20-3/4"L x 13"W x 11-7/8"H	Each	2



Open



Closed on a food pan



Open on a food pan

## STEAM PAN COVERS

SEE PAGE 154 FOR POLYCARBONATE LIDS



C-HFC1



C-DCH



C-HDC

## SPECIALTY COVERS

ITEM	DESCRIPTION	UOM	CASE
C-HFC1	Flat Hinged Cover, S/S	Each	6/12
C-HDC	Hinged Dome Cover with Handle, S/S	Each	12
C-DCF	Full-Size Dome Cover with Handle, S/S	Each	12
C-DCH	Half-Size Dome Cover with Handle, S/S	Each	24

## FLAT COVERS

- ◆ 18/8 stainless steel
- ◆ NSF listed

ITEM	DESCRIPTION	UOM	CASE
SPSCF	1/1 Solid Cover	Each	12/24
SPSCH	1/2 Solid Cover	Each	12/48
SPSCT	1/3 Solid Cover	Each	12/72
SPSCQ	1/4 Solid Cover	Each	12/72
SPSCS	1/6 Solid Cover	Each	12/72
SPSCN	1/9 Solid Cover	Each	12/72
SPSCTT	2/3 Solid Cover	Each	12/24
SPCF	1/1 Slotted Cover	Each	12/24
SPCH	1/2 Slotted Cover	Each	12/48
SPCT	1/3 Slotted Cover	Each	12/72
SPCQ	1/4 Slotted Cover	Each	12/72
SPCS	1/6 Slotted Cover	Each	12/72
SPCN	1/9 Slotted Cover	Each	12/72
SPCTT	2/3 Slotted Cover	Each	12/24



SPSCF



SOLID COVERS



SPCF



SLOTTED COVERS

## ADAPTOR BARS

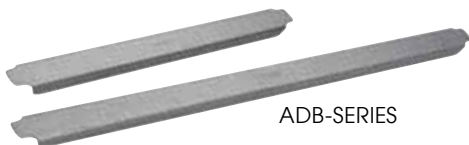

ADB-SERIES

## ADAPTOR BARS

- ◆ Stainless steel

ITEM	DESCRIPTION	UOM	CASE
ADB-12	12"	Each	12/144
ADB-20	20"	Each	12/120



### STAINLESS STEEL STEAM PAN GRATES

- ◆ Feet elevate food to keep from sticking to steam pan
- ◆ Can also be used as a cooling or icing rack
- ◆ Rust resistant

ITEM	DESCRIPTION	STEAM PAN SIZE	UOM	CASE
PGWS-1018	For Full-Size	10" x 18"	Each	12/48
PGWS-810	For Half-Size	8" x 10"	Each	12/48
PGWS-510	For Third-Size	5" x 10-1/2"	Each	12/48

### STEAM PAN GRATES

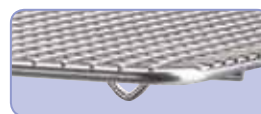

Raised Feet

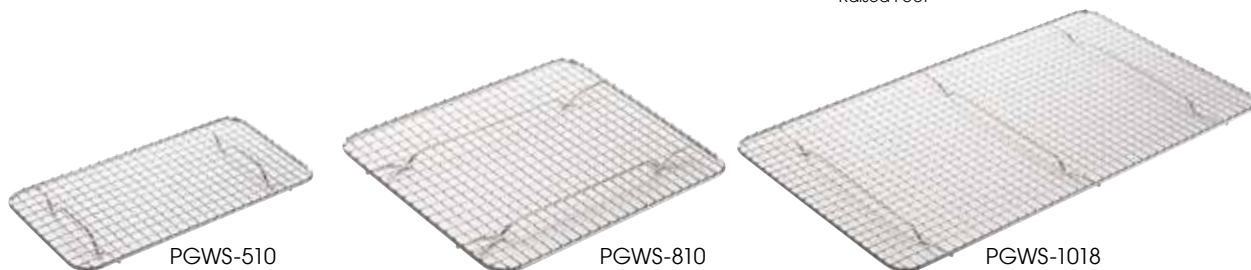

### CHROME-PLATED STEAM PAN GRATES

ITEM	DESCRIPTION	STEAM PAN SIZE	UOM	CASE
PGW-1018	For Full-Size	10" x 18"	Each	12/48
PGW-810	For Half-Size	8" x 10"	Each	12/48
PGW-510	For Third-Size	5" x 10-1/2"	Each	12/48

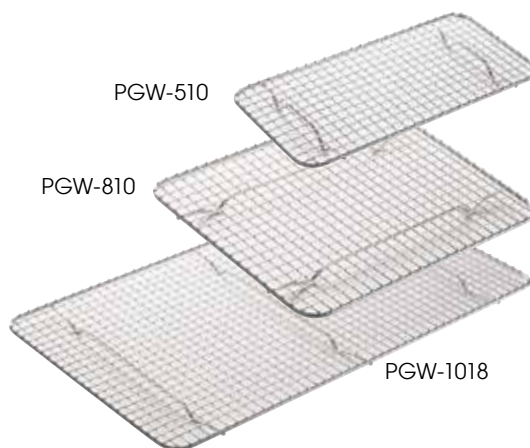

SEE PAGE 161 FOR SHEET PAN GRATES

### FALSE BOTTOMS

- ◆ 18/8 stainless steel
- ◆ Rust resistant
- ◆ Fits standard steam pan sizes

ITEM	DESCRIPTION	UOM	CASE
SPFB-1	Full-Size	Each	10/20
SPFB-2	Half-Size	Each	10/40
SPFB-3	Third-Size	Each	12/48
SPFB-4	Quarter-Size	Each	12/48
SPFB-6	Sixth-Size	Each	12/72
SPFB-9	Ninth-Size	Each	12/72

### FALSE BOTTOMS

IMPROVED

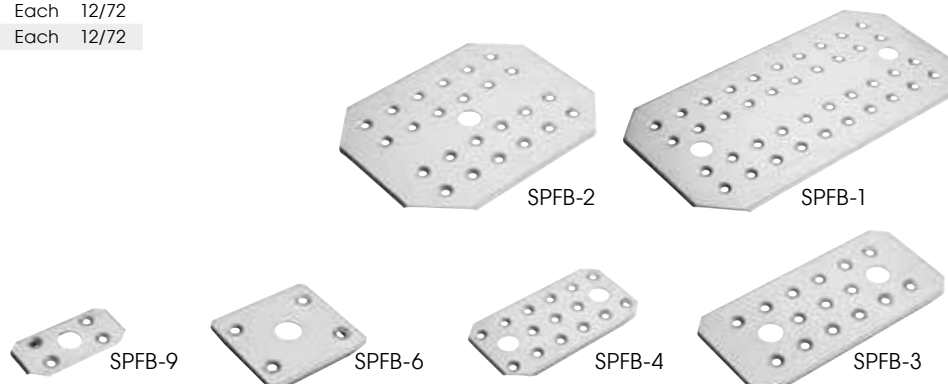



## Step up to Winco Prime® – A Cut Above

Winco Prime® products are made with industry approved materials that comply with or exceed accepted industry standards. All products in the Winco Prime family are NSF® listed to give a comfort level that every effort has been made to provide a safe and durable product at an affordable price. Winco Prime® products are safe to be used and will hold up well in the most demanding food service environment!

### NSF® BAIN-MARIES

### NSF® INSETS

AVAILABLE  
SUMMER 2017



**NEW** BAMN-6



**NEW** BAMN-6C



**NEW** INSN-7



INSC-7M

#### WINCO® PRIME BAIN-MARIES

ITEM	DESCRIPTION	SIZE	UOM	CASE
BAMN-1.25	1.25 Qt	5" x 6"	Each	6/48
BAMN-1.5	1.5 Qt	5-1/2" x 5-1/4"	Each	6/48
BAMN-2	2 Qt	5-3/4" x 7"	Each	6/48
BAMN-3.5	3.5 Qt	7-1/4" x 7"	Each	6/36
BAMN-4.25	4.25 Qt	7-1/4" x 7-3/4"	Each	6/36
BAMN-6	6 Qt	8" x 8-3/4"	Each	6/24
BAMN-8.25	8.25 Qt	9" x 9-3/4"	Each	6/24
BAMN-12	12 Qt	10" x 10-1/2"	Each	6/12

#### WINCO® PRIME INSET PANS

ITEM	DESCRIPTION	SIZE	UOM	CASE
INSN-2.5	2.5 Qt	6" x 7-1/2"	Each	6/36
INSN-4	4 Qt	7-1/2" x 7-1/2"	Each	6/36
INSN-7	7 Qt	9-1/2" x 8"	Each	6/24
INSN-11	11 Qt	11-1/2" x 9"	Each	6/12

#### BAIN-MARIE COVERS

ITEM	DESCRIPTION	UOM	CASE
BAMN-1.25C	Cover for BAMN-1.25	Each	12/144
BAMN-1.5C	Cover for BAMN-1.5	Each	12/144
BAMN-2C	Cover for BAMN-2	Each	12/144
BAMN-3.5C	Cover for BAMN-3.5	Each	12/144
BAMN-4.25C	Cover for BAMN-4.25	Each	12/72
BAMN-6C	Cover for BAMN-6	Each	12/72
BAMN-8.25C	Cover for BAMN-8.25	Each	12/48
BAMN-12C	Cover for BAMN-12	Each	12/24

#### INSET COVERS (NON-NSF)

ITEM	DESCRIPTION	UOM	CASE
INSC-2.5	Cover for INSN-2.5	Each	6/72
INSC-4	Cover for INSN-4	Each	6/36
INSC-7M	Cover for INSN-7	Each	6/48
INSC-11M	Cover for INSN-11	Each	6/36

**BAIN-MARIES**

- ◆ Stainless steel mirror finish
- ◆ Bent rim for easier handling and lifting

ITEM	DESCRIPTION	SIZE	UOM	CASE
BAM-1.25	1.25 Qt	5" x 6"	Each	6/48
BAM-1.5	1.5 Qt	5-1/2" x 5-1/4"	Each	6/48
BAM-2	2 Qt	5-3/4" x 7"	Each	6/48
BAM-3.5	3.5 Qt	7-1/4" x 7"	Each	6/36
BAM-4.25	4.25 Qt	7-1/4" x 7-3/4"	Each	6/36
BAM-6	6 Qt	8" x 8-3/4"	Each	6/24
BAM-8.25	8.25 Qt	9" x 9-3/4"	Each	6/24
BAM-12	12 Qt	10" x 10-1/2"	Each	3/6

**BAIN-MARIE COVERS**

- ◆ Stainless steel

ITEM	DESCRIPTION	UOM	CASE
BAMC-1.25	For 1.25 Qt Bain Marie	Each	12/144
BAMC-2	For 2 Qt Bain Marie	Each	12/144
BAMC-3.5	For 3.5 Qt Bain Marie	Each	12/144
BAMC-4.25	For 4.25 Qt Bain Marie	Each	12/72
BAMC-6	For 6 Qt Bain Marie	Each	12/72
BAMC-8.25	For 8.25 Qt Bain Marie	Each	12/48
BAMC-12	For 12 Qt Bain Marie	Each	12/24

**INSET PAN**

- ◆ Stainless steel mirror finish

ITEM	DESCRIPTION	SIZE	UOM	CASE
INS-2.5	2.5 Qt	6" x 7-1/2"	Each	6/36
INS-4.0	4 Qt	7-1/2" x 7-1/2"	Each	6/36
INS-7.0M	7 Qt, 24 gauge	9-1/2" x 8"	Each	6/24
INS-11.0M	11 Qt, 24 gauge	11-1/2" x 9"	Each	6/12

**INSET COVERS**

- ◆ Stainless steel

ITEM	DESCRIPTION	UOM	CASE
INSC-2.5	For 2.5 Qt Inset	Each	6/72
INSC-4	For 4 Qt Inset	Each	6/36
INSC-7M	For 7 Qt Inset	Each	6/48
INSC-11M	For 11 Qt Inset	Each	6/36

**HINGED COVERS**

- ◆ Stainless Steel

ITEM	DESCRIPTION	UOM	CASE
INSH-7	For 7 Qt Inset	Each	6/24
INSH-11	For 11 Qt Inset	Each	6/24

**ADAPTOR PLATES**

- ◆ Stainless steel

ITEM	DESCRIPTION	SIZE	UOM	CASE
ADP-608	6-3/8" and 8-3/8" Inset Holes	Fits 4 Qt and 7 Qt	Each	10
ADP-610	6-3/8" and 10-3/8" Inset Holes	Fits 4 Qt and 11 Qt	Each	10
ADP-666	Three 6-3/8" Inset Holes	Fits 4 Qt	Each	10
ADP-808	Two 8-3/8" Inset Holes	Fits 7 Qt	Each	10
ADP-810	8-3/8" and 10-3/8" Inset Holes	Fits 7 Qt and 11 Qt	Each	10
ADP-444	Adaptor Plate, Six 4-3/4" Inset Holes	Fits 2.5 Qt	Each	10

**BAIN-MARIES**



BAM-6



BAMC-SERIES

**INSETS**



INS-7.0M



INSC-7M

INSH-7

**ADAPTOR PLATES**

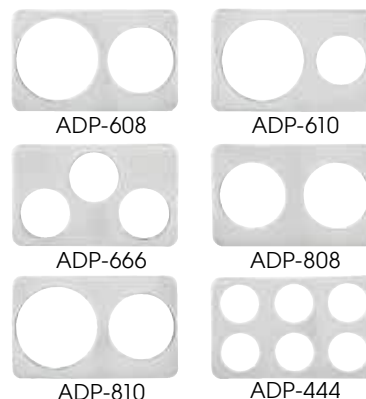

OVERALL SIZE: 21" X 13"

# POLYCARBONATE FOOD PANS

## PAN SIZING

SIZE	DIMENSIONS
Full-Size	20-3/4" x 12-1/2"
1/2-Size	12-3/4" x 10-3/8"
1/3-Size	12-5/8" x 6-7/8"
1/4-Size	10-1/4" x 6-1/4"
1/6-Size	6-3/4" x 6-1/4"
1/9-Size	7-7/8" x 4-1/4"

WITHSTAND TEMPS FROM -40°F TO 210°F



SEE PAGE 150 FOR ADAPTOR BARS

## FOOD PANS

◆ NSF listed

ITEM	PAN SIZE	DEPTH	UOM	CASE
SP7102	Full-Size	2-1/2"	Each	6/12
SP7104		3-1/2"	Each	6/12
SP7106		5-1/2"	Each	6/12
SP7108		7-3/4"	Each	6/12
SP7202	1/2-Size	2-1/2"	Each	12/24
SP7204		3-1/2"	Each	6/24
SP7206		5-1/2"	Each	6/12
SP7208		7-3/4"	Each	6/12
SP7302	1/3-Size	2-1/2"	Each	12/24
SP7304		3-1/2"	Each	12/24
SP7306		5-1/2"	Each	6/24
SP7308		7-3/4"	Each	6/12
SP7402	1/4-Size	2-1/2"	Each	12/36
SP7404		3-1/2"	Each	12/36
SP7406		5-1/2"	Each	6/24
SP7602	1/6-Size	2-1/2"	Each	12/36
SP7604		3-1/2"	Each	12/48
SP7606		5-1/2"	Each	6/24
SP7902	1/9-Size	2-1/2"	Each	12/72
SP7904		3-1/2"	Each	12/72

## COVERS FOR FOOD PANS

◆ NSF listed

ITEM	COVER STYLE	UOM	CASE
SP7100C	Slotted	Each	12/24
SP7100S	Solid	Each	12/24
SP7200C	Slotted	Each	12/48
SP7200S	Solid	Each	12/48
SP7300C	Slotted	Each	12/72
SP7300S	Solid	Each	12/72
SP7400C	Slotted	Each	12/72
SP7400S	Solid	Each	12/72
SP7600C	Slotted	Each	12/72
SP7600S	Solid	Each	12/72
SP7900C	Slotted	Each	12/72
SP7900S	Solid	Each	12/72

## DOMES

- ◆ Made of durable polycarbonate plastic
- ◆ C-DP1, C-DPF1 and C-DPFH fit full-size steam table pans and poly pans
- ◆ C-DP2 and C-DPF2 fit half-size steam table pans and poly pans
- ◆ NSF listed

ITEM	DESCRIPTION	SIZE	UOM	CASE
C-DP1	Full-Size Cover, NSF	21-1/2" x 13-3/4"	Each	12
C-DP2	1/2-Size Cover, NSF	13-1/2" x 11"	Each	24
C-DPF1	Full-Size Flip Cover, NSF	21-1/2" x 13-3/4"	Each	12
C-DPF2	1/2-Size Cut-out Cover, NSF	13-1/2" x 11"	Each	24
C-DPFH	Full-Size Hinged Cover	21" x 13"	Each	12



## DRAIN SHELVES

◆ NSF listed

ITEM	DESCRIPTION	SIZE	UOM	CASE
SP71DS	Full-Size	18-5/16" x 10-1/4"	Each	10/20
SP72DS	1/2-Size	10-1/4" x 7-7/8"	Each	10/40
SP73DS	1/3-Size	10-1/4" x 4-7/16"	Each	20/80
SP74DS	1/4-Size	8" x 3-15/16"	Each	20/80
SP76DS	1/6-Size	4-7/16" x 4-1/4"	Each	20/120

SP7-SERIES DRAIN SHELVES

## FOOD STORAGE BOXES

### CLEAR POLYCARBONATE

- ◆ Full-size measures 18" x 26"
- ◆ Half-size measures 12" x 18"
- ◆ Heavyweight
- ◆ NSF listed

ITEM	DESCRIPTION	UOM	CASE
PFSF-6	Full-Size 6"	Each	6
PFSF-9	Full-Size 9"	Each	4
PFSF-12	Full-Size 12"	Each	3
PFSF-15	Full-Size 15"	Each	3
PFSF-C	Full-Size Cover for PFSF-Series	Each	12
PFSH-3	Half-Size 3-1/2"	Each	12
PFSH-6	Half-Size 6"	Each	6
PFSH-9	Half-Size 9"	Each	6
PFSH-C	Half-Size Cover for PFSH-Series	Each	24



PFSF & PFSH-SERIES NSF

PFSF-C

### WHITE POLYPROPYLENE

- ◆ NSF listed
- ◆ BPA-free

ITEM	DESCRIPTION	UOM	CASE
PFFW-3	Full-Size 3"	Each	6
PFFW-6	Full-Size 6"	Each	6
PFFW-9	Full-Size 9"	Each	6
PFFW-12	Full-Size 12"	Each	6
PFFW-15	Full-Size 15"	Each	6
PFFW-C	Full-Size Cover for PFFW-Series	Each	6
PFHW-3	Half-Size 3"	Each	12
PFHW-6	Half-Size 6"	Each	12
PFHW-9	Half-Size 9"	Each	12
PFHW-C	Half-Size Cover for PFHW-Series	Each	6



PFFW & PFHW-SERIES NSF BPA FREE

### POLYCARBONATE DRAIN SHELVES

- ◆ NSF listed

ITEM	DESCRIPTION	SIZE	UOM	CASE
PFSF-DS	Drain Shelf for PFSF	18" x 26"	Each	12
PFSH-DS	Drain Shelf for PFSH	12" x 18"	Each	24



PFSF-DS

DRAIN SHELVES NSF

## SQUARE FOOD STORAGE CONTAINERS



NSF® PCSC-SERIES



NSF®  
BPA FREE PTSC-SERIES



NSF®  
BPA FREE PESC-SERIES

SEE PAGE 207  
FOR MORE OF THE  
ALLERGEN-FREE LINE



PECC-128P, PECC-68P, PECC-24P



PECC-24, PECC-68, PECC-128



PECC-S, PECC-M, PECC-L

Winco® offers a wide selection of NSF listed boxes and containers to meet all your food storage needs. Our food storage containers come in round and square shapes, in both clear polycarbonate (PC) and polypropylene (PP).

- ◆ Clear polycarbonate is extremely durable, stackable, withstands temperatures from -40°F to 210°F, and is ideal for the storage and transport of raw or prepared food
- ◆ Polypropylene is stain resistant, withstands temperatures from -40°F to 160°F, and is ideal for the storage and transport of prepared food only
- ◆ Built-in handles, graduation markings in liters and quarts
- ◆ Dishwasher safe

### CLEAR POLYCARBONATE

- ◆ NSF listed

ITEM	DESCRIPTION	UOM	CASE
PCSC-2C	2 Qt	Each	12/60
PCSC-4C	4 Qt	Each	12/48
PCSC-6C	6 Qt	Each	12/24
PCSC-8C	8 Qt	Each	12/24
PCSC-12C	12 Qt	Each	12
PCSC-18C	18 Qt	Each	12
PCSC-22C	22 Qt	Each	6

### TRANSLUCENT POLYPROPYLENE

- ◆ NSF listed, BPA-free

ITEM	DESCRIPTION	UOM	CASE
PTSC-2	2 Qt	Each	12/60
PTSC-4	4 Qt	Each	12/48
PTSC-6	6 Qt	Each	12/24
PTSC-8	8 Qt	Each	12/24
PTSC-12	12 Qt	Each	12
PTSC-18	18 Qt	Each	12
PTSC-22	22 Qt	Each	6

### WHITE POLYPROPYLENE

- ◆ NSF listed, BPA-free

ITEM	DESCRIPTION	UOM	CASE
PESC-2	2 Qt	Each	12/60
PESC-4	4 Qt	Each	12/48
PESC-6	6 Qt	Each	12/24
PESC-8	8 Qt	Each	12/24
PESC-12	12 Qt	Each	12
PESC-18	18 Qt	Each	12
PESC-22	22 Qt	Each	6

### POLYETHYLENE ALLERGEN-FREE COVERS

Solve the challenges of maintaining an allergen-aware kitchen! Improve customer dining experiences while raising the bar for food safety. Prevent cross-contaminating allergens with the extensive line of Allergen-Free tools by Winco®. Whether it's gluten, nuts or more, use this stand-out purple color to designate these storage containers as allergen-free.

ITEM	DESCRIPTION	COLOR	UOM	CASE
PECC-24P	Fits 2 Qt & 4 Qt	Purple	Each	12
PECC-68P	Fits 6 Qt & 8 Qt	Purple	Each	12
PECC-128P	Fits 12 Qt, 18 Qt, 22 Qt	Purple	Each	6

### POLYETHYLENE COVERS

ITEM	DESCRIPTION	COLOR	UOM	CASE
PECC-24	Fits 2 Qt & 4 Qt	Green	Each	12
PECC-68	Fits 6 Qt & 8 Qt	Red	Each	12
PECC-128	Fits 12 Qt, 18 Qt, 22 Qt	Blue	Each	6
PECC-S	Fits 2 Qt & 4 Qt	White	Each	12
PECC-M	Fits 6 Qt & 8 Qt	White	Each	12
PECC-L	Fits 12 Qt, 18 Qt, 22 Qt	White	Each	6

Winco® offers a wide selection of NSF listed boxes and containers to meet all your food storage needs. Our food storage containers come in round and square shapes, in both clear polycarbonate and polypropylene.

- ◆ Clear polycarbonate is extremely durable, stackable, withstands temperatures from -40°F to 210°F, and is ideal for the storage and transport of raw or prepared food
- ◆ Polypropylene is stain resistant, withstands temperatures from -40°F to 160°F, and is ideal for the storage and transport of prepared food only
- ◆ Built-in handles, graduation markings in liters and quarts
- ◆ Dishwasher safe

### CLEAR POLYCARBONATE

- ◆ NSF listed

ITEM	DESCRIPTION	UOM	CASE
PCRC-1	1 Qt	Each	48
PCRC-2	2 Qt	Each	24
PCRC-4	4 Qt	Each	12
PCRC-6	6 Qt	Each	12
PCRC-8	8 Qt	Each	12
PCRC-12	12 Qt	Each	12
PCRC-18	18 Qt	Each	6
PCRC-22	22 Qt	Each	6
PCRC-1C	Cover, Fits 1 Qt	Each	12
PCRC-24C	Cover, Fits 2 Qt and 4 Qt	Each	12
PCRC-68C	Cover, Fits 6 Qt and 8 Qt	Each	12
PCRC-1222C	Cover, Fits 12 Qt, 18 Qt, 22 Qt	Each	6

## ROUND FOOD STORAGE CONTAINERS



PCRC-6  
PCRC-24C

PCRC-2

PCRC-8

PCRC-SERIES 

### TRANSLUCENT POLYPROPYLENE

- ◆ NSF listed, BPA-free

ITEM	DESCRIPTION	UOM	CASE
PTRC-1	1 Qt	Each	48
PTRC-2	2 Qt	Each	24
PTRC-4	4 Qt	Each	12
PTRC-6	6 Qt	Each	12
PTRC-8	8 Qt	Each	12
PTRC-12	12 Qt	Each	12
PTRC-18	18 Qt	Each	6
PTRC-22	22 Qt	Each	6
PTRC-1C	Cover, Fits 1 Qt	Each	12
PTRC-24C	Cover, Fits 2 Qt and 4 Qt	Each	12
PTRC-68C	Cover, Fits 6 Qt and 8 Qt	Each	12
PTRC-1222C	Cover, Fits 12 Qt, 18 Qt, 22 Qt	Each	6



PTRC-6  
PTRC-24C

PTRC-2

PTRC-8

PTRC-SERIES  

### WHITE POLYPROPYLENE

- ◆ NSF listed, BPA-free

ITEM	DESCRIPTION	UOM	CASE
PPRC-1W	1 Qt	Each	48
PPRC-2W	2 Qt	Each	24
PPRC-4W	4 Qt	Each	12
PPRC-6W	6 Qt	Each	12
PPRC-8W	8 Qt	Each	12
PPRC-12W	12 Qt	Each	12
PPRC-18W	18 Qt	Each	6
PPRC-22W	22 Qt	Each	6
PPRC-1C	Cover, Fits 1 Qt	Each	12
PPRC-24C	Cover, Fits 2 Qt and 4 Qt	Each	12
PPRC-68C	Cover, Fits 6 Qt and 8 Qt	Each	12
PPRC-1222C	Cover, Fits 12 Qt, 18 Qt, 22 Qt	Each	6



PPRC-6W  
PPRC-24C

PPRC-2W

PPRC-8W

PPRC-SERIES  

## INGREDIENT BINS



IB-21

IB-27



3" Caster Wheels with Brakes



Convenient Scoop Storage

NSF IB-SERIES

## DURABLE POLYPROPYLENE INGREDIENT BINS

- ◆ Ideal for mobile storage in the kitchen
- ◆ Advanced super-clasp lid design makes it easy to scoop ingredients without removing the entire cover
- ◆ Easily identify contents through the clear plastic polycarbonate front cover & keep foods fresher longer
- ◆ 3" caster wheels with brakes make this bin convenient to move from one kitchen work area to another
- ◆ Scoop handle designed to remain out of ingredients and prevent contamination
- ◆ NSF listed

ITEM	DESCRIPTION	SIZE	UOM	CASE
IB-21	21 Gal	13" x 29-1/4" x 28"	Set	1
IB-27	27 Gal	15-1/2" x 29-1/2" x 28"	Set	1
IB-C3	3" Caster For IB-21 and IB-27		Each	1
IB-C3B	Caster w/Break For IB-21 and IB-27		Each	1
IB-21-LE	Lid for IB-21		Each	6
IB-27-LE	Lid for IB-27		Each	6

ITEM #	WEIGHT SUGAR	WEIGHT FLOUR
IB-21	159 lbs	124 lbs
IB-27	197 lbs	154 lbs

## SHELF INGREDIENT BINS



## POLYPROPYLENE SHELF INGREDIENT BINS

- ◆ Stackable for more storage space
- ◆ One-handed lift lid design to increase efficiency
- ◆ Clear plastic polycarbonate front lid to quickly identify ingredients
- ◆ Scoop with dedicated clip to ensure sanitation compliance
- ◆ NSF listed

ITEM	DESCRIPTION	SIZE	UOM	CASE
IB-2S	2 Gallon, 40 Cup	11-3/4" x 14-1/4" x 8-3/8"	Each	1
IB-5S	5 Gallon, 80 Cup	11-1/8" x 23-3/8" x 16-7/8"	Each	1
IB-10S	10 Gallon, 150 Cup	19-1/4" x 23-3/8" x 16-7/8"	Each	1

NSF IB-SERIES

IB-2S

IB-5S

IB-10S

## FOOD STORAGE CONTAINERS

## POLYETHYLENE FOOD STORAGE CONTAINERS

- ◆ Lids sold separately, NSF listed



FCW-32L

FCW-32 & FCW-32RC

ITEM	DESCRIPTION	UOM	CASE
FCW-10	Container, 10 Gal	Each	6
FCW-20*	Container, 20 Gal	Each	6
FCW-32*	Container, 32 Gal	Each	6
FCW-10L	PP Lid for FCW-10	Each	24
FCW-20L	PP Lid for FCW-20	Each	12
FCW-32L	PP Lid for FCW-32	Each	12
FCW-10RC	PC Rotating Lid for FCW-10	Each	6
FCW-20RC	PC Rotating Lid for FCW-20	Each	6
FCW-32RC	PC Rotating Lid for FCW-32	Each	6

\*Fits DLR-series dollies (see p.247)

ITEM #	CAPACITY (GALLONS)	CAPACITY (CUPS)	FLOUR (LBS)	SUGAR (LBS)
FCW-10	10	150	47	65
FCW-20	20	300	94	130
FCW-32	32	500	156	217

NSF FCW-SERIES



### DOUGH BOXES & COVER

- ◆ Boxes stack tight to maintain freshness of contents
- ◆ Great for storing and proofing dough
- ◆ Reinforced structure resists breakage/bending over time
- ◆ Made of durable polypropylene
- ◆ BPA-free

ITEM	DESCRIPTION	UOM	CASE
PL-3N	25-5/8"L x 18"W x 3-1/4"H	Each	6
PL-6N	25-1/2"L x 17-1/2"W x 6"H	Each	3
PL-36NC	Cover	Each	12

Replaces PL-3, PL-6, PL-36C



Stackable



Reinforced edges & corners

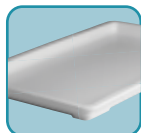

Lid can be used as tray



Seamless fit for fresh storage

### WIRE DOUGH BOX DOLLY

Transport multiple dough boxes with ease using this wire dolly, currently the only one on the market!

- ◆ Capacity up to 400 Lbs
- ◆ Winco® exclusive
- ◆ Wheels measure 3-3/4" Dia each

ITEM	DESCRIPTION	UOM	CASE
DWR-2617	27"L x 18-1/4"W x 2-1/2"H	Each	1

### DOUGH BOXES & DOLLY



IMPROVED STRUCTURE

PL-SERIES

BPA FREE



Transport dough boxes



DWR-2617

### DELI CROCKS & COVERS

The beautiful fluted-finish, combined with durable SAN plastic makes these crocks ideal for deli counter and picnic buffet presentations.

- ◆ BPA-free

ITEM	DESCRIPTION	COLOR	UOM	CASE
CRK-10R	10" x 7" x 3"	Red	Each	24
CRK-10K	10" x 7" x 3"	Black	Each	24
CRK-10C	10" x 7" x 3"	Clear	Each	24
CRK-10W	10" x 7" x 3"	White	Each	24
CRK-13R	13" x 10" x 3"	Red	Each	12
CRK-13K	13" x 10" x 3"	Black	Each	12
CRK-13C	13" x 10" x 3"	Clear	Each	12
CRK-13W	13" x 10" x 3"	White	Each	12
CRKC-10	Cover for CRK-10 Series	Clear	Each	48
CRKC-13	Cover for CRK-13 Series	Clear	Each	48

### DELI CROCKS & COVERS



CRK-SERIES

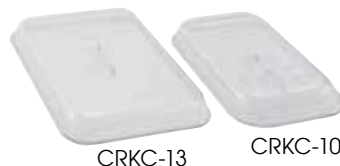

CRKC-13

CRKC-10

CRK & CRKC SERIES

BPA FREE



### POLYPROPYLENE BEVERAGE CONTAINER/DISPENSER

This container dispenser comes with a secure fit snap-on lid and handle for easy transport.

- ◆ Leak-proof faucet and snap-on lid
- ◆ Bail-style handle with comfortable handgrip
- ◆ Red graduations in liters and quarts
- ◆ Temperature range from -40°F to 160°F
- ◆ Dishwasher safe

ITEM	DESCRIPTION	UOM	CASE
PBDW-22	6 Gal, PP	Each	4
PBDW-FS	Faucet for PBDW-22	Each	1

### BEVERAGE DISPENSER



PBDW-22

PBDW-SERIES

BPA FREE



## SHEET PANS



ALXP-0609

NEW  
SIZE

ALXP-2216H



Closed bead



NSF ALXP-1200



Open bead



ALXP-1318P



WINCO's "dense" perforation vs. others



FFT-1826

FFT-1826YL

NSF FFT-SERIES

New Item

## ALUMINUM SHEET PANS

Whether they are reinforced with galvanized wire or extra heavy-duty open bead, Winco® sheet pans can be counted on to hold their shape in high oven temperatures during baking, roasting or broiling.

- ◆ Closed bead with galvanized wire for rust resistance and reinforcement
- ◆ Made of 3003 aluminum
- ◆ Heavy-duty open bead pans also useful as roasting pans
- ◆ ALXP-1200 is NSF listed

ITEM	DESCRIPTION	SIZE	GAUGE	UOM	CASE
ALXP-0609	1/8-Size Open Bead	6" x 9"	16	Each	24
ALXP-1013	1/4-Size Closed Bead	9-1/2" x 13"	20	Each	24
ALXP-1310H	1/4-Size Closed Bead	10" x 13"	18	Each	24
ALXP-1318	1/2-Size Closed Bead	13" x 18"	20	Each	12
ALXP-1813H	1/2-Size Closed Bead	13" x 18"	18	Each	12
ALXP-1622	2/3-Size Closed Bead	16" x 22"	19	Each	12
ALXP-2216H	2/3-Size Closed Bead	16" x 22"	18	Each	12
ALXP-1826	Full-Size Closed Bead	18" x 26"	18	Each	12
ALXP-2618H	Full-Size Closed Bead	18" x 26"	16	Each	12
ALXP-1200	Full-Size Open Bead, NSF	18" x 26"	12	Each	12

## ALUMINUM SHEET PANS - PERFORATED (CLOSED BEAD)

The denser hole perforations on these sheet pans allow for better air circulation and heat conductivity, typically preferred by bakers for a crispier outcome.

- ◆ Perforated holes are 1/8" diameter
- ◆ Made of 3003 aluminum

ITEM	DESCRIPTION	SIZE	GAUGE	UOM	CASE
ALXP-1318P	1/2-Size	13" x 18"	18	Each	12
ALXP-1826P	Full-Size	18" x 26"	18	Each	12
ALXP-2618P	Full-Size	18" x 26"	16	Each	12

## PLASTIC SHEET TRAYS

- ◆ Can also be used as a plastic sheet pan
- ◆ NSF listed

ITEM	DESCRIPTION	COLOR	UOM	CASE
FFT-1826	18" x 26"	White	Each	12
FFT-1826YL	18" x 26"	Yellow	Each	6

### SHEET PAN COVERS

- ◆ Protects food products during transport or storage
- ◆ Excellent reusable alternative to film or foil
- ◆ Easily snaps onto most aluminum sheet pans in full or half-sizes
- ◆ Polypropylene plastic
- ◆ Dishwasher safe

ITEM	DESCRIPTION	SIZE	UOM	CASE
CXP-1826	Full-Size	18" x 26"	Each	24
CXP-1318	Half-Size	13" x 18"	Each	24



### SHEET PAN EXTENDER

- ◆ Great for making sheet cakes without using a cake pan
- ◆ Flat top edges for easy gripping
- ◆ Flat top of extender also allows sheet pans to be stacked while baked goods cool
- ◆ 2" height
- ◆ Hand wash only
- ◆ Aluminum

ITEM	DESCRIPTION	SIZE	UOM	CASE
AXPE-1	Full-Size	18" x 26"	Each	12
AXPE-2	Half-Size	13" x 18"	Each	12
AXPE-4	Quarter-Size	9-1/2" x 13"	Each	12

### SHEET PAN ACCESSORIES



CXP-SERIES  
(sheet pan not included)



Make sheet cakes without cake pan



AXPE-2

### STAINLESS STEEL WIRE SHEET PAN GRATES

- ◆ Footed to elevate food to keep from sticking to sheet pan
- ◆ Can also be used as a cooling or icing rack

ITEM	DESCRIPTION	SHEET PAN SIZE	UOM	CASE
PGWS-2416	16" x 24"	For Full-Size	Each	12/24
PGWS-1216	12" x 16-1/2"	For Half-Size	Each	12/48

### SHEET PAN GRATES



PGWS-1216

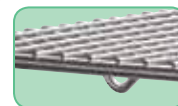

Raised Feet



### CHROME-PLATED WIRE SHEET PAN GRATE

ITEM	DESCRIPTION	SHEET PAN SIZE	UOM	CASE
PGW-2416	16" x 24"	For Full-Size	Each	12/24
PGW-1420	14" x 20"	For 2/3-Size	Each	12/24
PGW-1216	12" x 16-1/2"	For Half-Size	Each	12/48



PGW-1420

SEE PAGE 151 FOR STEAM PAN GRATES



### ALLERGEN-FREE PURPLE SILICONE BAKING MATS

Whether it's gluten or nuts, use this stand-out purple color to designate these mats Allergen-Free.

- ◆ Double-sided and reusable up to 2,000 times
- ◆ Provides consistent and even heat distribution
- ◆ Woven fiberglass coated with food grade silicone
- ◆ Temperature tolerance from -40°F to 540°F

ITEM	DESCRIPTION	SIZE	UOM	CASE
SBS-11PP	1/4-Size	8-1/4" x 11-3/4"	Each	20/100
SBS-16PP	1/2-Size	11-5/8" x 16-1/2"	Each	10/50
SBS-21PP	2/3-Size	14-7/16" x 20-1/2"	Each	10/50
SBS-24PP	Full-Size	16-3/8" x 24-1/2"	Each	10/50

### SILICONE BAKING MATS



SBS-21PP

SEE PAGE 207 FOR MORE OF THE ALLERGEN-FREE LINE



### RECTANGULAR SILICONE BAKING MATS

- ◆ Reusable up to 2,000 times, use both sides
- ◆ Provides consistent even heat distribution
- ◆ Woven fiberglass coated with food grade silicone
- ◆ Temperature tolerance from -40°F to 540°F

ITEM	DESCRIPTION	SIZE	UOM	CASE
SBS-11	1/4-Size	8-1/4" x 11-3/4"	Each	20/100
SBS-16	1/2-Size	11-5/8" x 16-1/2"	Each	10/50
SBS-21	2/3-Size	14-7/16" x 20-1/2"	Each	10/50
SBS-24	Full-Size	16-3/8" x 24-1/2"	Each	10/50



SBS-SERIES



# ALUMINUM SHEET PAN & BUN RACKS



Winco's exclusive Weld<sup>2</sup> System features fail-safe rigidity through both bolting and welding at all critical joints to prevent warping with long term, high-traffic use



AWRK-20  
\*10 Tier Available



Specialty bolts secure each joint



Bolt caps are welded over completely to form extra-strength juncture

Made for the most demanding restaurant kitchens, these aluminum sheet pan racks accommodate standard full-size 18" x 26" sheet/bun pans, or twice the capacity for half-size 18" x 13" pans. All racks are shipped knocked down and require assembly except for the welded series.

## WELDED SHEET PAN RACKS

- ◆ Featuring Winco's exclusive Weld<sup>2</sup> Dual Weldment System
- ◆ Heavy-duty caster wheels handle loads up to 650 lbs
- ◆ NSF listed

ITEM	DESCRIPTION	UOM	CASE
AWRK-10	10-Tier, 3" Spacing	Each	1
AWRK-20	20-Tier, 3" Spacing	Each	1

## SHEET PAN RACKS WITH BRAKES

- ◆ Ships knocked down
- ◆ NSF listed

ITEM	DESCRIPTION	UOM	CASE
ALRK-10BK	10-Tier, 3" Spacing	Each	1
ALRK-20BK	20-Tier, 3" Spacing	Each	1
ALRK-30BK	30-Tier, 2" Spacing (with heavyweight casters)	Set	1

## SHEET PAN RACKS

- ◆ Ships knocked down
- ◆ NSF listed

ITEM	DESCRIPTION	UOM	CASE
ALRK-10	10-Tier w/o Brake	Each	1
ALRK-20	20-Tier w/o Brake	Each	1

### NSF ALRK/AWRK-SERIES



ALRK-10BK    ALRK-20BK    ALRK-30BK

## SHEET PAN RACK ACCESSORIES

ITEM	DESCRIPTION	UOM	CASE
ALRK-10-CV	Cover for 10-Tier Rack	Each	12
ALRK-20-CV	Cover for 20- and 30-Tier Racks	Each	12
ALRC-5ST	Caster for ALRK and AWRK-series	Each	12
ALRC-5STK	Caster w/Brake for ALRK & AWRK-series	Each	12
ALRC-5H	Caster for ALRK-30BK, Heavyweight	Each	12
ALRC-5HK	Caster w/Brake for ALRK-30BK, Heavyweight	Each	12

## REPLACEMENT CASTERS FOR SHEET PAN RACKS

ITEM	ALRK-3	ALRK-15	ALRK-10	ALRK-20	ALRK-10BK	ALRK-20BK	ALRK-30BK	AWRK-10	AWRK-20
ALRC-5P	4								
ALRC-5ST		2	4	4	2	2		4	2
ALRC-5STK		2			2	2			2
ALRC-5H							2		
ALRC-5HK							2		



ALRK-10    ALRK-20



ALRK-10-CV    ALRK-20-CV



ALRC-5STK  
5" caster with brake

### COUNTER-HEIGHT SHEET PAN RACK

- ◆ Rack has slides and a hard top that can be used as cutting board stand
- ◆ 14 gauge 6063 aluminum with 1" extruded tube frame
- ◆ Full swivel casters, 5" diameter x 1-1/4"
- ◆ Capacity is 15 full-size (18" x 26") or 30 half-size (18" x 13") sheet pans (not included)
- ◆ Ships knocked down
- ◆ NSF listed

ITEM	DESCRIPTION	SIZE	UOM	CASE
ALRK-15	15-Tier	26-1/8"L x 20-7/8"W x 31-5/8"H	Set	1

### ALUMINUM SHEET PAN & BUN RACKS



ALRK-15 NSF

### SHEET PAN TRUCK

- ◆ 14 gauge 6063 aluminum with 1" extruded aluminum tube frame
- ◆ Full swivel casters, 5" diameter x 1-1/4" width
- ◆ Capacity is 54 full-size (18" x 26") or 108 half-size (13" x 18") sheet pans (not included)
- ◆ Ships knocked down
- ◆ NSF listed

ITEM	DESCRIPTION	SIZE	UOM	CASE
ALRK-3	Sheet Pan Truck	28-7/8"L x 20-5/8"W x 33-3/8"H	Set	1
ALRC-5P	Replacement Caster for ALRK-3		Each	12



ALRK-3

ALRK-SERIES NSF

### ICING/COOLING RACK

- ◆ Built-in feet

ITEM	DESCRIPTION	SIZE	UOM	CASE
ICR-1725	Rectangular	16-1/4" x 25"	Each	6/12

### COOLING RACKS



ICR-1725



STR-15

### STEAMER RACKS

- ◆ Built-in feet

ITEM	DESCRIPTION	SIZE	UOM	CASE
STR-10	Round	10-3/7"	Each	10
STR-13	Round	12-3/4"	Each	10
STR-15	Round	14-3/4"	Each	10
STR-18	Round	17-3/4"	Each	10

### DOUGHNUT BASKET

- ◆ Nickel-plated

ITEM	DESCRIPTION	UOM	CASE
DB-1218	12"L x 18"W x 2"H	Each	24

### DOUGHNUT BASKET

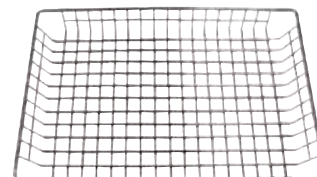

DB-1218

## RECTANGULAR CAKE PANS



PFOA FREE

HSCP-0808

PFOA FREE

HRCP-1812



ACP-0913

ACP-1212



PFOA FREE

HLF-SERIES

HLF-100



### ALUMINIZED STEEL CAKE PANS

- ◆ Quantum2® non-stick coating (double-coated)
- ◆ Withstands temperatures to 500°F (260°C)
- ◆ 24 gauge non-stick aluminized steel
- ◆ Wire-in reinforced rim with folded body construction
- ◆ PTFE/PFOA-free
- ◆ Dishwasher safe

ITEM	DESCRIPTION	SIZE	UOM	CASE
HRCP-1309	Rectangular	13" x 9" x 2-1/4"	Each	6
HRCP-1812	Rectangular	18" x 12" x 3"	Each	6
HSCP-0808	Square	8" x 8" x 2-1/4"	Each	6



### ALUMINUM CAKE PANS

- ◆ Straight sided, perfect for commercial baking
- ◆ Extended 1/2" flange for easy and safe handling
- ◆ Heavyweight for even heat distribution
- ◆ 1.6mm thickness, 16 gauge

ITEM	DESCRIPTION	SIZE	UOM	CASE
ACP-0913	Rectangular	9" x 13" x 2"	Each	6
ACP-1212	Square	12" x 12" x 2"	Each	6



### ALUMINIZED STEEL LOAF PANS

- ◆ Quantum2® non-stick coating (double-coated)
- ◆ Withstands temperatures up to 500°F (260°C)
- ◆ 24 gauge non-stick aluminized steel
- ◆ Wire-in reinforced rim with folded body construction
- ◆ PTFE/PFOA-free
- ◆ Dishwasher safe

ITEM	DESCRIPTION	SIZE	UOM	CASE
HLF-100	1 lb Loaf	8-1/2" x 4-1/2" x 2-3/4"	Each	6
HLF-150	1-1/2 lb Loaf	10" x 5" x 3"	Each	6

## SHEET CAKE MARKERS



CKM-69



### SHEET CAKE MARKERS

*A must-have for bakeries and buffets to achieve consistently sized square cuts.*

- ◆ Stainless steel
- ◆ Full-size: 24-3/4"L x 16-3/4"W x 1"H

ITEM	DESCRIPTION	UOM	CASE
CKM-68	6 x 8, Marks (48) 3" x 3" Pieces	Each	24
CKM-69	6 x 9, Marks (56) 2-1/2" x 2-1/2" Pieces	Each	24
CKM-610	6 x 10, Marks (60) 2-1/4" x 2-1/2" Pieces	Each	24

## BREAD FORM



SBF-5K



### SILICONE BREAD FORM

- ◆ Non-stick silicone surface requires no oils or sprays
- ◆ Heats quickly and bakes evenly
- ◆ Ideal size for 12" long sandwich bread
- ◆ Dishwasher, oven, microwave and freezer safe
- ◆ Heat resistant up to 425°F (218°C)

ITEM	DESCRIPTION	SIZE	UOM	CASE
SBF-5K	5 Roll	18" x 13"	Each	12/144

## DELUXE HARD ANODIZED ALUMINUM CAKE PANS

◆ 1.0mm thickness, 18 gauge

ITEM	DESCRIPTION	UOM	CASE
HAC-042	4"Dia x 2"H	Each	6/24
HAC-062	6"Dia x 2"H	Each	6/24
HAC-082	8"Dia x 2"H	Each	6/24
HAC-102	10"Dia x 2"H	Each	6/24
HAC-122	12"Dia x 2"H	Each	6/24
HAC-142	14"Dia x 2"H	Each	6/24
HAC-162	16"Dia x 2"H	Each	6/12

## ALUMINUM LAYER-CAKE PANS

ITEM	DESCRIPTION	UOM	CASE
ACP-062	6"Dia x 2"H	Each	6/36
ACP-082	8"Dia x 2"H	Each	6/36
ACP-083	8"Dia x 3"H	Each	6/36
ACP-092	9"Dia x 2"H	Each	6/36
ACP-093	9"Dia x 3"H	Each	6/36
ACP-102	10"Dia x 2"H	Each	6/36
ACP-103	10"Dia x 3"H	Each	6/36
ACP-122	12"Dia x 2"H	Each	6/36
ACP-123	12"Dia x 3"H	Each	6/24

## ALUMINUM PIE PLATES

ITEM	DESCRIPTION	UOM	CASE
APPL-8	8"Dia	Each	12/72
APPL-9	9"Dia	Each	12/72
APPL-10	10"Dia	Each	12/72
APPL-11	11"Dia	Each	12/72

## QUICHE/TART PANS

- ◆ Removable bottom eliminates damaging the crust by allowing for easy extraction of delicate molds
- ◆ Dishwasher safe

ITEM	DESCRIPTION	UOM	CASE
FQP-4	4"Dia x 3/4"H, 2-Pcs/Set	Set	6
FQP-8	8"Dia x 1-1/2"H	Each	6
FQP-10	10"Dia x 1-1/4"H	Each	6
FQP-12	12"Dia x 1-3/8"H	Each	6

## CAST ALUMINUM PIE/CAKE MARKERS

ITEM	DESCRIPTION	UOM	CASE
APM-06	6-Cut	Each	12/48
APM-07	7-Cut	Each	12/48
APM-08	8-Cut	Each	12/48
APM-10	10-Cut	Each	12/48
APM-12	12-Cut	Each	12/48

## STAINLESS STEEL PIE CUTTERS

ITEM	DESCRIPTION	UOM	CASE
SCU-6	6-Cut	Each	6/12
SCU-7	7-Cut	Each	6/12
SCU-8	8-Cut	Each	6/12

## DOUBLE-SIDED CAKE MARKERS

- ◆ Scores cakes up to 10" round for even slices
- ◆ Food grade polypropylene plastic

ITEM	DESCRIPTION	UOM	CASE
PCM-1012	10 & 12 Slice Marks	Each	12/24
PCM-1416	14 & 16 Slice Marks	Each	12/24

## WIRE CAKE LEVELER

*This essential baker's tool is a must-have for making beautiful, thinly layered cakes and tortes.*

- ◆ Adjustable stainless steel cutting wire with 10 notches
- ◆ Accommodates 10" diameter cakes that are 2" high

ITEM	DESCRIPTION	UOM	CASE
WLC-12	12" Bow	Each	24/144

## ROUND CAKE PANS



## MARKERS & CUTTERS

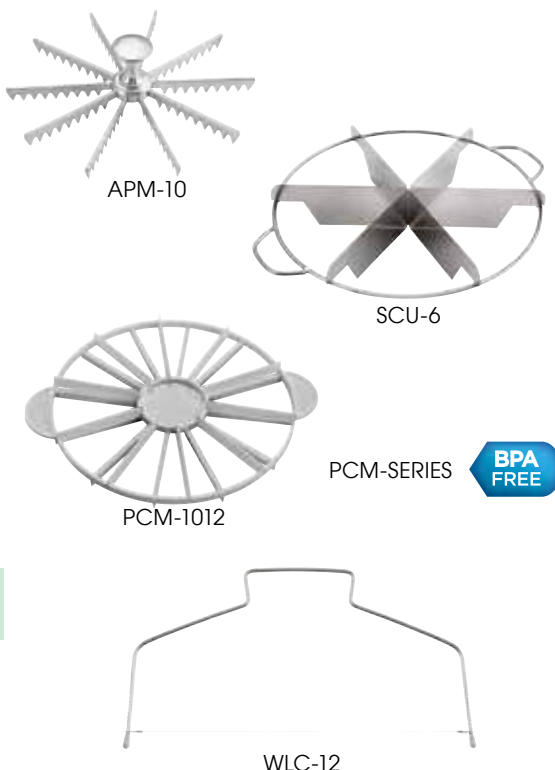

## SPRINGFORM PANS



HSP-123

PFOA FREE

HSP-SERIES



AASP-093



CPSF-9



### ALUMINIZED STEEL SPRINGFORM PANS

- ◆ Quantum2® non-stick coating (double-coated)
- ◆ Withstands temperatures up to 500°F (260°C)
- ◆ 24 gauge
- ◆ Dishwasher safe
- ◆ PTFE/PFOA-free

ITEM	DESCRIPTION	UOM	CASE
HSP-063	6"Dia x 2-3/4"H	Set	6
HSP-083	8"Dia x 2-3/4"H	Set	6
HSP-093	9"Dia x 2-3/4"H	Set	6
HSP-103	10"Dia x 2-3/4"H	Set	6
HSP-123	12"Dia x 2-3/4"H	Set	6



### ANODIZED ALUMINUM SPRINGFORM PANS

- ◆ Durable, non-stick, bakes evenly and releases cleanly
- ◆ Oven safe up to 450°F (232°C)
- ◆ Hand wash recommended

ITEM	DESCRIPTION	UOM	CASE
AASP-063	6"Dia x 3"H	Each	36
AASP-093	9"Dia x 3"H	Each	24

### TIN SPRINGFORM PANS

ITEM	DESCRIPTION	UOM	CASE
CPSF-8	8"Dia x 3"H	Each	12/36
CPSF-9	9-1/2"Dia x 3"H	Each	12/24
CPSF-10	10"Dia x 3"H	Each	12/24

## SPECIALTY CAKE PANS

PFOA FREE



CCP-10F



### FLUTED CAKE PAN

- ◆ Quantum2® non-stick aluminized carbon steel
- ◆ Ideal for making bundt cakes
- ◆ Dishwasher safe
- ◆ PTFE/PFOA-free

ITEM	DESCRIPTION	UOM	CASE
CCP-10F	10"Dia x 3-1/4"H	Each	6

PFOA FREE



CCP-10A



### ANGEL FOOD CAKE PANS

- ◆ Quantum2® non-stick coating
- ◆ Dishwasher safe
- ◆ PTFE/PFOA-free

ITEM	DESCRIPTION	UOM	CASE
CCP-10A	10"Dia x 5"H Removable Bottom, Aluminized Carbon Steel	Each	6
NACP-10	10"Dia x 4"H Carbon Steel	Each	12/24

PFOA FREE



NACP-10



### TURK HEAD MOLD

- ◆ Non-stick carbon steel

ITEM	DESCRIPTION	UOM	CASE
NTHM-8	8-1/2"Dia x 4"H	Each	12/24

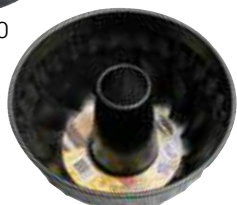

NTHM-8



### REGULAR MUFFIN PANS

ITEM	DESCRIPTION	SIZE	CAPACITY	UOM	CASE
AMF-12	12 Cup, Alu	14" x 11"	3 Oz	Each	12/24
AMF-24	24 Cup, Alu	20-1/2" x 14"	3 Oz	Each	12
AMF-12NS	12 Cup, Non-stick Carbon Steel	15-1/2" x 11"	3 Oz	Each	24
AMF-24NS	24 Cup, Non-stick Heavy Alu	20-1/2" x 14"	3 Oz	Each	12



AMF-24NS



AMF-12NS



AMF-24



AMF-12

### JUMBO MUFFIN PAN

- ◆ Non-stick carbon steel

ITEM	DESCRIPTION	SIZE	CAPACITY	UOM	CASE
AMF-6NS	6 Cup	13" x 8-1/2"	7 Oz	Each	24



AMF-6NS

### MINI MUFFIN PANS

- ◆ Non-stick carbon steel

ITEM	DESCRIPTION	SIZE	CAPACITY	UOM	CASE
CMF-12M	12 Cup	10" x 7-3/4"	3/4 Oz	Each	6
AMF-24MNS	24 Cup	13-3/4" x 10-1/2"	1-1/2 Oz	Each	12

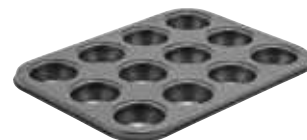

CMF-12M



AMF-24MNS

### COOKIE SHEET

- ◆ Deluxe hard anodized aluminum
- ◆ Durable, non-stick and bakes evenly
- ◆ Safe in temperatures up to 450°F (232°C)
- ◆ Hand wash recommended

ITEM	DESCRIPTION	SIZE	UOM	CASE
CS-2014	15 Gauge	20" x 14"	Each	4/16

### COOKIE SHEET



CS-2014

## CAKE DECORATING



### REVOLVING CAKE DECORATING STAND

- ◆ Made of aluminum alloy with a smooth ball-bearing mechanism
- ◆ Cast iron base with silicone bottom for steady grip

ITEM	DESCRIPTION	UOM	CASE
CKSR-12	12"Dia	Each	6

### CAKE STAND & COVER

- ◆ Assembly required for cake stand and cover
- ◆ Covers available for full case purchase only

ITEM	DESCRIPTION	SIZE	UOM	CASE
CKS-13	Cake Stand, S/S	13" Dia	Each	6/12
CKS-13C	Cover for CKS-13, Plastic	12" Dia	Each	6



### STAINLESS STEEL TRIANGLE DECORATING COMBS

- ◆ 1.0mm thickness
- ◆ 3 different jagged teeth edges on each piece
- ◆ Each pack contains six (6) pieces
- ◆ NSF Listed

ITEM	DESCRIPTION	UOM	CASE
SDC-6	Fine, Medium, and Coarse in One Piece	Pack	12/48



SDC-6



## SPATULAS



TWPO & TWPS-SERIES



TKPO & TKPS-SERIES



- ◆ Stainless steel
- ◆ Satin finish
- ◆ NSF listed



### WHITE ERGO HANDLE

- ◆ Dishwasher safe

ITEM	DESCRIPTION	BLADE	UOM	CASE
TWPO-4	Offset Spatula*	3-1/2" x 3/4"	Each	24/288
TWPO-7	Offset Spatula*	6-1/2" x 1-5/16"	Each	12/144
TWPO-9	Offset Spatula*	8-1/2" x 1-1/2"	Each	12/144
TWPS-4	Bakery Spatula	4" x 3/4"	Each	24/288
TWPS-7	Bakery Spatula	7-15/16" x 1-1/4"	Each	12/144
TWPS-9	Bakery Spatula	10" x 1-3/8"	Each	12/144

\*Measurement reflects blade size not including offset



### BLACK ERGO HANDLE

- ◆ Dishwasher safe

ITEM	DESCRIPTION	BLADE	UOM	CASE
TKPO-4	Offset Spatula*	3-1/2" x 3/4"	Each	24/288
TKPO-7	Offset Spatula*	6-1/2" x 1-5/16"	Each	12/144
TKPO-9	Offset Spatula*	8-1/2" x 1-1/2"	Each	12/144
TKPS-4	Bakery Spatula	4" x 3/4"	Each	24/288
TKPS-7	Bakery Spatula	7-15/16" x 1-1/4"	Each	12/144
TKPS-9	Bakery Spatula	10" x 1-3/8"	Each	12/144

\*Measurement reflects blade size not including offset

### WOODEN HANDLE SPATULAS

ITEM	DESCRIPTION	BLADE	UOM	CASE
TNS-4	Bakery Spatula	4" x 3/4"	Each	24/288
TNS-7	Bakery Spatula	7-15/16" x 1-1/4"	Each	12/144
TNS-9	Bakery Spatula	10" x 1-3/8"	Each	12/72
TOS-4	Spatula Offset	3-1/2" x 3/4"	Each	24/288
TOS-7	Spatula Offset	6-1/2" x 1-5/16"	Each	12/144
TOS-9	Spatula Offset	8-1/2" x 1-1/2"	Each	12/72

\*Measurement reflects blade size not including offset

### CAKE DECORATING TIP SETS

Create delicate and pretty confections with these decorating tips made of rust-resistant stainless steel. Decorating tip sets come in a convenient storage box. The 26 and 52 piece sets include a standard coupler and metal flower nail.

ITEM	DESCRIPTION	UOM	CASE
CDT-24	24-Pc Set	Set	60
CDT-26	26-Pc Set	Set	12/48
CDT-52	52-Pc Set	Set	6/24



Convenient storage tray



CDT-24



CDT-26

### DECORATING TIP SETS



CDT-52

### CANVAS PASTRY BAG

◆ Plastic-coated interior

ITEM	DESCRIPTION	UOM	CASE
PBC-12	12"	Each	12/576
PBC-14	14"	Each	12/576
PBC-16	16"	Each	12/576
PBC-18	18"	Each	12/576
PBC-21	21"	Each	12/576
PBC-24	24"	Each	12/288

### PASTRY BAGS



PBC-16



CDTC-2

### PLASTIC COUPLINGS

ITEM	DESCRIPTION	UOM	CASE
CDTC-2	2-Pc Set	Set	12/360

# COOKIE & PASTRY CUTTERS

Create sweet, delicate confections with these cookie and pastry cutters made of rust-resistant stainless steel. Available in assorted shapes and sizes.



CST-1



CST-2



CST-12



CST-22



## PASTRY CUTTERS

ITEM	DESCRIPTION	SHAPE	UOM	CASE
CST-31	8-pc Pastry Set	Butterflies	Set	12/60
CST-32	12-pc Pastry Set	Shapes	Set	12/60
CST-33	6-pc Pastry Set	Holiday	Set	12/60
CST-34	26-pc Pastry Set	Letters	Set	12/48



## COOKIE CUTTERS

ITEM	DESCRIPTION	SHAPE	UOM	CASE
CST-1	11-Pc Set	Fluted Round	Set	12/48
CST-2	11-Pc Set	Plain Round	Set	12/48
CST-12	11-Pc Set, 2"H	Fluted Round	Set	24
CST-22	11-Pc Set, 2"H	Plain Round	Set	24



CST-31



CST-32



CST-33



CST-34



CC-1



CC-2

## DEEP COOKIE CUTTER

- ◆ Ideal for cutting dough for biscuits
- ◆ 2-1/2" deep cut

ITEM	DESCRIPTION	UOM	CASE
CC-1	3"Dia, S/S	Each	12/120

## DOUGHNUT CUTTER

- ◆ 2-1/2" deep cut

ITEM	DESCRIPTION	UOM	CASE
CC-2	3"Dia, S/S	Each	12/120

**CULINARY PASTRY MOLDS**

Perfect for baking, freezing, cutting and forming, these ring molds are extremely versatile kitchen tools. Create attractive plate presentations by layering salads and grains, or bake individual cake and pastry portions without waste.

- ◆ Stainless steel
- ◆ Polished smooth to a brilliant mirror finish
- ◆ Dishwasher safe

ITEM	DESCRIPTION	UOM	CASE
SPM-21R	Round, 2"Dia x 1-3/4"H	Each	12/72
SPM-23R	Round, 2"Dia x 3"H	Each	12/72
SPM-31R	Round, 3"Dia x 1-3/4"H	Each	12/72
SPM-31O	Oval, 3"L x 1-3/8"H	Each	12/72
SPM-41O	Oval, 4"L x 1-3/8"H	Each	12/72
SPM-22S	Square, 2"L x 2"W x 2"H	Each	12/72
SPM-275S	Square, 2-3/4"L x 2-3/4"W x 2-3/4"H	Each	12/72
SPM-211T	Rectangular, 2-1/2"L x 1-3/4"W x 1-3/4"H	Each	12/72



**PASTRY MOLDS**



## DOUGH PREPARATION



ALDP-SERIES

## DOUGH RETARDING/PROOFING PANS & COVERS

- ◆ Stackable for easy storage
- ◆ Aluminum

ITEM	DESCRIPTION	UOM	CASE
ALDP-48	48 Oz, 7-7/8"Dia x 3"H	Each	12/24
ALDP-48C	Cover for ALDP-48	Each	120
ALDP-96	96 Oz, 8-3/4"Dia x 3"H	Each	12/24
ALDP-96C	Cover for ALDP-96	Each	120

## DOUGH BOXES & COVER



PL-36NC

IMPROVED STRUCTURE

PL-3N

PL-6N



BPA FREE

PL-SERIES

SEE PAGE 159 FOR DOUGH BOX DOLLY

## DOUGH BOXES & COVER

- ◆ Boxes stack tight to maintain freshness of contents
- ◆ Great for storing and proofing dough
- ◆ Reinforced structure resists breakage/bending over time
- ◆ Made of durable polypropylene
- ◆ BPA-free

ITEM	DESCRIPTION	UOM	CASE
PL-3N	25-5/8"L x 18"W x 3-1/4"H	Each	6
PL-6N	25-1/2"L x 17-1/2"W x 6"H	Each	3
PL-36NC	Cover	Each	12

Replaces PL-3, PL-6, PL-36C



Stackable



Reinforced edges & corners

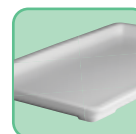

Lid can be used as tray



Seamless fit for fresh storage

## DOUGH SCRAPERS

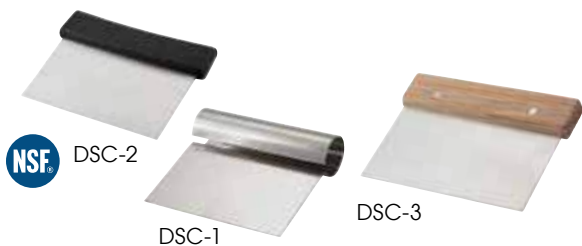

DSC-2

DSC-1

DSC-3



SEE PAGE 207 FOR MORE OF THE ALLERGEN-FREE LINE

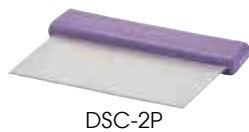

DSC-2P



PDS-7P



PDS-7



PDS-5

## DOUGH SCRAPERS

- ◆ Stainless steel

ITEM	DESCRIPTION	BLADE	UOM	CASE
DSC-1	Steel Handle	5-1/4" x 4-1/4"	Each	12/48
DSC-2	Plastic Handle, NSF	6" x 3"	Each	12/120
DSC-3	Wooden Handle	6" x 3"	Each	12/120



## ALLERGEN-FREE DOUGH SCRAPERS

Solve the challenges of maintaining an allergen-aware kitchen! Improve customer dining experiences while raising the bar for food safety. Prevent cross-contaminating allergens with this extensive line of Allergen-Free tools by Winco®. Whether it's gluten, nuts or more, use this stand-out purple color to designate these dough scrapers as allergen-free.

ITEM	DESCRIPTION	SIZE	UOM	CASE
DSC-2P	Dough Scraper, S/S Blade	6" x 3"	Each	12/72
PDS-7P	Plastic Dough Scrapers, 6pcs/pk	7-1/2" x 4-3/4"	Pack	24/48

## PLASTIC DOUGH SCRAPERS



ITEM	DESCRIPTION	SIZE	UOM	CASE
PDS-7	Large, 6-Pcs/Pk	7-1/2" x 4-3/4"	Pack	24/48
PDS-5	Small, 12-Pcs/Pk	5-1/2" x 3-3/4"	Doz	21/42

**DOUGH DIVIDERS WITH ADJUSTABLE WHEELS**

- ◆ Stainless steel wheels adjustable from 3/4" to approximately 4-3/4" for ADD-6 and 4-3/8" for ADD-5

ITEM	DESCRIPTION	UOM	CASE
ADD-5	5-Wheel	Each	36
ADD-6	6-Wheel	Each	36

**DOUGH ROLLER DOCKERS**

- ◆ Stainless steel handle
- ◆ 8" Overall Length

ITEM	DESCRIPTION	UOM	CASE
RD-2	2-5/8"W Head	Each	24
RD-5	5"W Head	Each	24
RD-8	5"W Head, 8-Wheel	Each	24

**PLASTIC ROLLER DOCKERS**

- ◆ 6 independently spinning wheels on the RD-4P
- ◆ Prevent bubbles from forming

ITEM	DESCRIPTION	UOM	CASE
RD-4P	4"W Head, Molded Ergonomic Handle	Each	24
RD-5P	5"W Head, Plastic Handle	Each	12/72

**DOUGH WHEELS/DOCKERS**

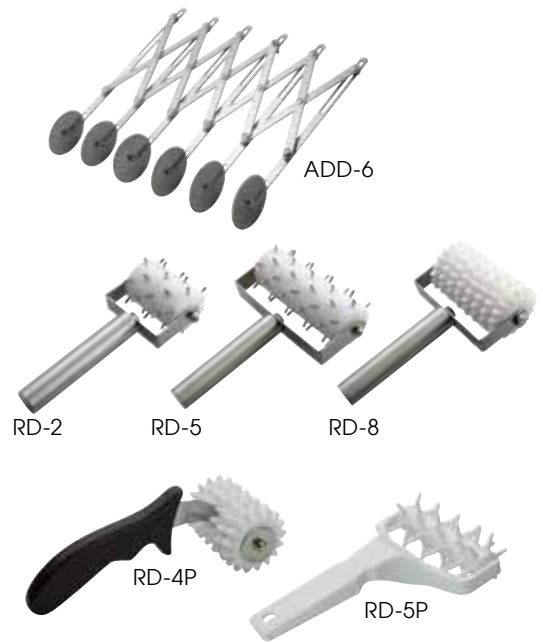

**ALUMINUM ROLLING PINS**

ITEM	DESCRIPTION	UOM	CASE
ARP-13	13"L x 3-1/2"Dia	Each	6
ARP-15	15"L x 3-1/2"Dia	Each	6
ARP-18	18"L x 3-1/2"Dia	Each	6

**WOODEN ROLLING PINS**

ITEM	DESCRIPTION	UOM	CASE
WRP-13	13"L x 2-3/4" Dia	Each	12
WRP-15	15"L x 2-3/4" Dia	Each	12
WRP-18	18"L x 2-3/4" Dia	Each	12

**FRENCH WOODEN ROLLING PIN**

ITEM	DESCRIPTION	UOM	CASE
WRP-20F	20"L x 1-3/16"Dia, Tapered	Each	12/48

**ROLLING PINS**

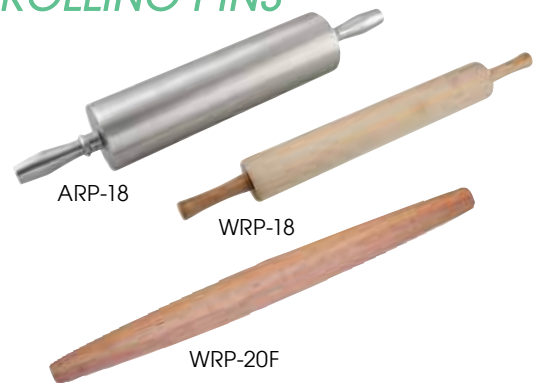

**DOUBLE PASTRY WHEEL**

- ◆ Features 2 separate stainless steel blades, straight & fluted
- ◆ Ideal for ravioli, strudel, pastry dough
- ◆ Sturdy stainless steel blades with ergonomic plastic handle
- ◆ Safety guard for hand protection
- ◆ Hole in handle for convenient hanging
- ◆ Dishwasher safe

ITEM	DESCRIPTION	UOM	CASE
PPC-1D	Double Pastry Wheel	Each	12/144

**ECONOMY PASTRY BLENDER**

ITEM	DESCRIPTION	UOM	CASE
PST-5B	5 Blades, S/S	Each	12/72

**PERFECT PIE BLENDER**

*The Connoisseur pastry blender is faster, cleaner, easier, and more consistent than any other pastry utensil on the market today. The ergonomically designed Pastry Pro allows you to make perfect pastry in 60 seconds!*

- ◆ Patented stainless steel diamond shape cutting blades designed to cut through flour and butter
- ◆ Rubberized handle
- ◆ Dishwasher safe

ITEM	DESCRIPTION	UOM	CASE
PSTCO-7	7 Blades	Each	6/24

**PASTRY TOOLS**



## BATTER DISPENSERS

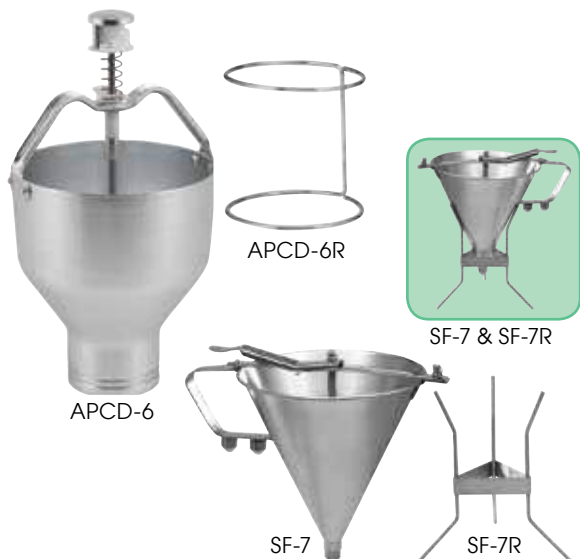

## ALUMINUM PANCAKE DISPENSER

- ◆ Durable plunger ensures consistent amounts of batter every time
- ◆ Eight portion-control settings range from 1/2 oz to 8 oz
- ◆ 10 gauge high-grade aluminum body
- ◆ Long lasting parts prevent clogging and leaking

ITEM	DESCRIPTION	UOM	CASE
APCD-6	Pancake Dispenser	Each	6
APCD-6R	Rack for APCD-6, No Retail Pkg.	Each	12/48

## CONFECTIONERY FUNNEL

- ◆ Use to dispense a smooth flow of fondant, syrup, or prepared creams
- ◆ Spring valve feature allows for easy control with single-handed operation
- ◆ Comes with 3 nozzles: 4mm, 5mm, 6mm
- ◆ Rack not included

ITEM	DESCRIPTION	UOM	CASE
SF-7	Funnel, S/S	Each	8
SF-7R	Rack for SF-7, S/S	Each	24

## SIFTERS



## ROTARY SIFTER

ITEM	DESCRIPTION	UOM	CASE
RFS-8	8 Cup, S/S	Each	12

## SIEVES

- ◆ Stainless steel #20 mesh

ITEM	DESCRIPTION (DIA X H)	UOM	CASE
SIV-10	10" x 3"	Each	6
SIV-12	12" x 3"	Each	6
SIV-14	14" x 3"	Each	6
SIV-16	16" x 3"	Each	6

## FUNNELS



## WIDE-MOUTH FUNNELS & REMOVABLE STRAINERS

- ◆ Stainless steel mirror finish for SF-5 and SF-6

ITEM	DESCRIPTION	UOM	CASE
SF-5	5" Funnel	Each	12/72
SF-6	5-3/4" Funnel	Each	12/72
SF-6S	Strainer for SF-6	Each	120/480

## SPUN ALUMINUM FUNNELS

- ◆ Made with one-piece spun aluminum

ITEM	DESCRIPTION	UOM	CASE
SAF-05	1/2 Pt, 3-7/8"Dia x 3-5/8"H	Each	12/192
SAF-1	1 Pt, 5-1/4"Dia x 5-1/2"H	Each	12/192
SAF-1ST	1 Pt w/Strainer, 5-1/4"Dia x 5-1/4"H	Each	6/150
SAF-2	1 Qt, 7"Dia x 6-5/8"H	Each	6/54
SAF-4	2 Qt, 9-1/8"Dia x 7-3/4"H	Each	6/72
SAF-8	4 Qt, 8-3/4"Dia x 8"H	Each	6/54

## PLASTIC FUNNELS

ITEM	DESCRIPTION	UOM	CASE
PF-8	8 Oz, 4"Dia	Each	6/324
PF-16	16 Oz, 5-1/4"Dia	Each	6/324
PF-32	32 Oz 6-1/4"Dia	Each	6/216

SAF-1ST inside detail



### STRAINER-SIFTER

Give baked delicacies a flavorful finish with this 3 inch sifter. The fine mesh makes it possible to craft that light sprinkle of powdered sugar, cocoa, nutmeg, etc.

- ◆ Stainless steel

ITEM	DESCRIPTION	UOM	CASE
MS2K-3S	8"L x 1"H O.L., 3"Dia	Each	24/144

### STRAINER-SIFTER



MS2K-3S

### POWDERED SUGAR DISPENSER

- ◆ Stainless steel
- ◆ Also ideal for cocoa, nutmeg or cinnamon
- ◆ Includes plastic cap

ITEM	DESCRIPTION	UOM	CASE
SSD-10	10 Oz	Each	12/60

### DREDGES



SSD-10



Includes plastic cap

### ADJUSTABLE SHAKER DREDGE

- ◆ 18/8 stainless steel mirror finish
- ◆ Features a three-way adjustable top with small, medium and large holes

ITEM	DESCRIPTION	UOM	CASE
DRG-8P	8 Oz	Each	12/96



DRG-8P



DRG-8P Adjustable Tap

### STAINLESS STEEL DREDGES

ITEM	DESCRIPTION	UOM	CASE
DRG-10	10 Oz w/Handle	Each	12/144
DRG-10H	10 Oz w/o Handle	Each	12/144
DRG-22H	22 Oz w/o Handle	Each	12/48



DRG-10



DRG-10H



DRG-22H

### ALUMINUM DREDGES

ITEM	DESCRIPTION	UOM	CASE
ADRG-10	10 Oz w/ Handle	Each	12/144
ADRG-10H	10 Oz w/o Handle	Each	12/144



ADRG-10



ADRG-10H

### PLASTIC DREDGE SETS

- ◆ 10 oz polycarbonate dredge sets with snap-on lids
- ◆ NSF listed

ITEM	DESCRIPTION	UOM	CASE
PDG-10	Dredge w/3 Clear Lids (S, M, L)	Set	48
PDG-10AC	Dredge w/4 Colored Lids	Set	48
PDG-10CS	10 Oz Dredge w/Clear S Lid	Set	12/48
PDG-10CM	10 Oz Dredge w/Clear M Lid	Set	12/48
PDG-10CL	10 Oz Dredge w/Clear L Lid	Set	12/48
PDG-10CXL	10 Oz Dredge w/Clear XL Lid	Set	12/48
PDG-10B	10 Oz Dredge w/Beige Lid	Set	12/48
PDG-10G	10 Oz Dredge w/Green Lid	Set	12/48
PDG-10R	10 Oz Dredge w/Rose Lid	Set	12/48
PDG-10Y	10 Oz Dredge w/Yellow Lid	Set	12/48



PDG-10

PDG-10AC

PDG-SERIES



### PLASTIC COLORED DREDGE LIDS

- ◆ Fits both PDG-10 and PDG-10AC dredges
- ◆ Each pack contains six (6) pieces

ITEM	DESCRIPTION	UOM	CASE
PDG-BL	Beige Lids	Pack	72/144
PDG-GL	Green Lids	Pack	72/144
PDG-RL	Rose Lids	Pack	72/144
PDG-YL	Yellow Lids	Pack	72/144



PDG-SERIES COLORED LIDS

## PASTRY BRUSHES

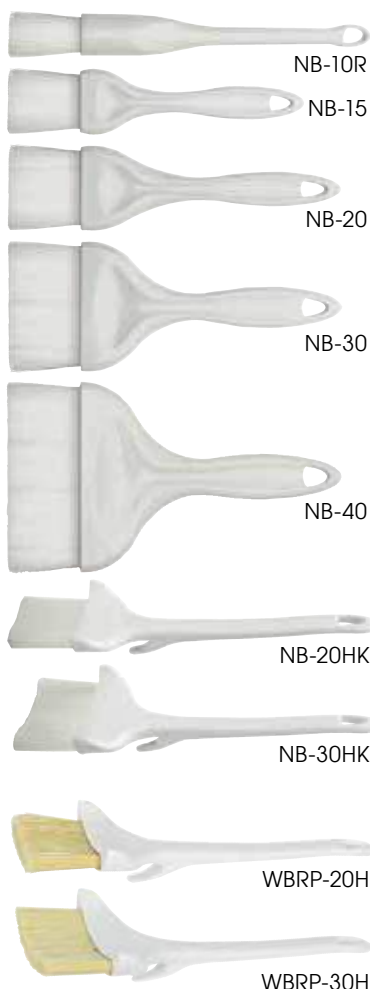

NB-10R

NB-15

NB-20

NB-30

NB-40

NB-20HK

NB-30HK

WBRP-20H

WBRP-30H



WFB-SERIES



WBR-SERIES



PBST-1.5

BPA FREE



OM-13

## NYLON BRISTLE PASTRY BRUSHES

Made for long lasting use, nylon bristle pastry brushes are versatile enough to use for basting meats or glazing pastries. Available in a variety of sizes to suit every need.

- ◆ Bristles are epoxy-set to ferrules which prevent bacteria from collecting
- ◆ Bristles are heat resistant up to 300°F (150°C)
- ◆ One-piece smooth-finish plastic handle for easy cleaning
- ◆ Dishwasher safe

ITEM	DESCRIPTION	SIZE	UOM	CASE
NB-10R	Round Brush	1" Dia	Each	12/240
NB-15	Flat Brush	1-1/2"	Each	12/240
NB-20	Flat Brush	2"	Each	12/240
NB-20HK	Concave With Hook	2"	Each	12/120
NB-30	Flat Brush	3"	Each	12/120
NB-30HK	Concave With Hook	3"	Each	12/120
NB-40	Flat Brush	4"	Each	12/120

## BOAR BRISTLE PASTRY BRUSHES

Made for heavy or thick sauces, boar bristle pastry brushes are ideal for basting meat and poultry.

- ◆ Concave natural boar bristles with plastic hook handle
- ◆ Hook allows the brush to rest on the edge of a pot or pan

ITEM	DESCRIPTION	SIZE	UOM	CASE
WBRP-20H	Concave With Hook	2"	Each	12/72
WBRP-30H	Concave With Hook	3"	Each	12/72

## PASTRY/BASTING BRUSHES

- ◆ Natural boar hair bristles
- ◆ WFB: wooden handle with plastic ferrules
- ◆ WBR: wooden handle with metal ferrules

ITEM	DESCRIPTION	SIZE	UOM	CASE
WFB-10	Flat Brush	1"	Each	12/144
WFB-10R	Round Brush	1" x 2"	Each	12/144
WFB-15	Flat Brush	1-1/2"	Each	12/144
WFB-20	Flat Brush	2"	Each	12/144
WFB-30	Flat Brush	3"	Each	12/72
WFB-40	Flat Brush	4"	Each	12/72
WBR-10	Flat Pastry Brush	1"	Each	12/600
WBR-15	Flat Pastry Brush	1-1/2"	Each	12/600
WBR-20	Flat Pastry Brush	2"	Each	12/240
WBR-25	Flat Pastry Brush	2-1/2"	Each	12/240
WBR-30	Flat Pastry Brush	3"	Each	12/240
WBR-40	Flat Pastry Brush	4"	Each	12/240

## PLASTIC BASTER

- ◆ 1.5 oz capacity with rubber bulb
- ◆ BPA-free

ITEM	DESCRIPTION	UOM	CASE
PBST-1.5	7-1/2" Tube, 11" O.L.	Each	12/72

## OIL MOP

ITEM	DESCRIPTION	UOM	CASE
OM-13	13" O.L.	Each	12/96

## TIMERS

ITEM	DESCRIPTION	TIME	UOM	CASE
TIM-78	Mechanical Timer	60 min	Each	12/36
TIM-85D	LCD Digital Timer w/20 min Stopper	20 hrs	Each	12/144



TIM-78



TIM-85D

## OVEN MITTS

- ◆ Heat-resistant up to 200°F (93°C)
- ◆ 100% cotton

ITEM	DESCRIPTION	UOM	CASE
OMS-13	13"	Each	12/72
OMS-15	15"	Each	12/72
OMS-17	17"	Each	12/72



OMS-SERIES

## FLAME RETARDANT OVEN MITTS

- ◆ Flame-resistant up to 400°F (205°C)
- ◆ OMF-24 is extra-long for full arm protection

ITEM	DESCRIPTION	UOM	CASE
OMF-13	13"	Each	12/72
OMF-15	15"	Each	12/72
OMF-17	17"	Each	12/72
OMF-24	24"	Each	12/72



OMF-SERIES

## TERRY OVEN MITTS

- ◆ Heat-resistant up to 600°F (315°C)

ITEM	DESCRIPTION	UOM	CASE
OMT-13	13"	Each	12/72
OMT-17	17"	Each	12/72



OMT-SERIES

SCRAPERS

SEE PAGE 207 FOR MORE OF THE ALLERGEN-FREE LINE



PSH-16P



IMPROVED DESIGN

PSH-series features raised ridges on the blade



PSH-SERIES



PSG-SERIES

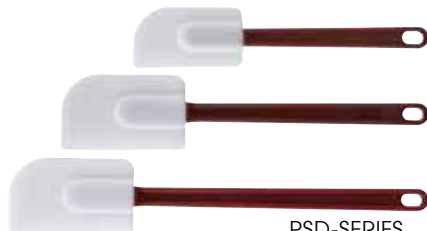

PSD-SERIES



PSGE-SERIES



PSC-SERIES



ALLERGEN-FREE COLOR CODED SCRAPER

Solve the challenges of maintaining an allergen-aware kitchen! Improve customer dining experiences while raising the bar for food safety. Prevent cross-contaminating allergens with the extensive line of Allergen-Free tools by Winco®. Whether it's gluten, nuts or more, use this stand-out purple color to designate these scrapers as allergen-free.

- ◆ Features raised ridges for resting to prevent messy counters
- ◆ Nylon handles heat-resistant up to 600°F (315°C)

ITEM	DESCRIPTION	UOM	CASE
PSH-10P	10-1/2"	Each	24/144
PSH-14P	14"	Each	24/144
PSH-16P	16-1/4"	Each	24/144



SILICONE SCRAPERS

- ◆ Features raised ridges for resting to prevent messy counters
- ◆ Nylon handles heat-resistant up to 600°F (315°C)

ITEM	DESCRIPTION	UOM	CASE
PSH-10	10-1/2"	Each	24/144
PSH-14	14"	Each	24/144
PSH-16	16-1/4"	Each	24/144

BOWL-SHAPED SILICONE SCRAPERS

- ◆ Heat-resistant up to 500°F (260°C)

ITEM	DESCRIPTION	UOM	CASE
PSG-10	10"	Each	12/120
PSG-14	14"	Each	12/120
PSG-16	16"	Each	12/120

ECONOMY SILICONE SCRAPERS

- ◆ Heat-resistant up to 500°F (260°C)

ITEM	DESCRIPTION	UOM	CASE
PSD-10	10"	Each	12/120
PSD-14	14"	Each	12/120
PSD-16	16"	Each	12/120

BOWL-SHAPED PLASTIC SCRAPERS

- ◆ BPA-free

ITEM	DESCRIPTION	UOM	CASE
PSGE-10	10"	Each	12/120
PSGE-14	14"	Each	12/72
PSGE-16	16"	Each	12/36



PLASTIC SCRAPERS

- ◆ BPA-free

ITEM	DESCRIPTION	UOM	CASE
PSC-10	10"	Each	24/360
PSC-14	14"	Each	12/288
PSC-16	16"	Each	12/288

### STAINLESS STEEL MIXING PADDLES

ITEM	DESCRIPTION	UOM	CASE
MPD-24	24"	Each	12
MPD-36	36"	Each	12
MPD-48	48"	Each	12
MPD-60	60"	Each	12

### WOODEN STIRRING PADDLES

ITEM	DESCRIPTION	UOM	CASE
WSP-18	18"	Each	4/36
WSP-24	24"	Each	4/36
WSP-36	36"	Each	4/36
WSP-48	48"	Each	4/36

### NYLON MIXING PADDLES

Mix, fold or spread anything from icing to batters with this nylon mixing paddle. The stain-resistant, sturdy one-piece construction is resistant to high temperatures, making it ideal for melting chocolate on hot stove tops.

◆ High temperature nylon is heat-resistant up to 425°F (218°C)

ITEM	DESCRIPTION	UOM	CASE
NSP-10W	10"	Each	12/120
NSP-14W	14"	Each	12/120
NSP-20W	20"	Each	12/120

### NYLON SPOONS

◆ One-piece construction, ideal for non-stick cookware  
 ◆ Stain resistant; Heat resistant up to 475°F (246°C)

ITEM	DESCRIPTION	UOM	CASE
NS-12B	12", Blue	Each	24/144
NS-12R	12", Red	Each	24/144
NS-12T	12", Tan	Each	24/144
NS-12W	12", Off-white	Each	24/144
NS-15B	15", Blue	Each	24/72
NS-15R	15", Red	Each	24/72
NS-15T	15", Tan	Each	24/72
NS-15W	15", Off-white	Each	24/72

### WOODEN SPOONS

ITEM	DESCRIPTION	UOM	CASE
WWP-12	12"	Doz	8
WWP-14	14"	Doz	8
WWP-16	16"	Doz	8
WWP-18	18"	Doz	8

### PADDLES & SPOONS



### DELUXE MEASURING CUPS

◆ Molded one-piece break-resistant polycarbonate  
 ◆ Raised external markings in both quarts (red letters) and liters (blue letters)  
 ◆ Tapered open handle for a secure grip; stackable  
 ◆ Dishwasher safe

ITEM	DESCRIPTION	UOM	CASE
PMCP-25	1 Cup	Each	6/72
PMCP-50	1 Pint	Each	6/72
PMCP-100	1 Qt	Each	6/36
PMCP-200	2 Qt	Each	6/36
PMCP-400	4 Qt	Each	6/24
PMCP-5SET	Complete 5-pc Set	Set	6

### MEASURING CUPS

◆ Durable polycarbonate w/raised graduation markings  
 ◆ NSF listed

ITEM	DESCRIPTION	UOM	CASE
PMU-25	1 Cup	Each	36
PMU-50	1 Pint	Each	36
PMU-100	1 Qt	Each	36
PMU-200	2 Qt	Each	36
PMU-400	4 Qt	Each	12

### PC MEASURING CUPS



## MEASURING TOOLS

**NEW**

MSL-5S



**NEW**

MSL-11



MSP-4P



MSPD-4X



**BPA FREE**

MSPP-4



MCP-4P



**BPA FREE**

MCPP-4



AM-2



SMB-SERIES



## MINI MEASURING LADLES

Easily portion and serve smaller quantities with mini ladles in varying capacities.

- ◆ Ideal for either measuring or serving small quantities
- ◆ Durable 18/8 stainless steel construction
- ◆ Capacity stamped on each handle

ITEM	DESCRIPTION	UOM	CASE
MSL-5S	5-Pc Set: 1/8 Tsp, 1/4 Tsp, 1/2 Tsp, 1 Tsp, 1 Tbsp	Set	12/72
MSL-11	3/4 Tbsp	Each	60/300



## STAINLESS STEEL MEASURING SPOON SETS

- ◆ Sets includes: 1/4 Tsp, 1/2 Tsp, 1 Tsp, 1 Tbsp

ITEM	DESCRIPTION	UOM	CASE
MSP-4P	4-Pc Set	Set	12/288
MSPD-4X	Deluxe 4-Pc Set	Set	24/240



## PLASTIC MEASURING SPOON SET

- ◆ Set includes: 1/4 Tsp, 1/2 Tsp, 1 Tsp, 1 Tbsp
- ◆ BPA-free

ITEM	DESCRIPTION	UOM	CASE
MSPP-4	4-Pc Set	Set	12/216

## STAINLESS STEEL MEASURING CUP SET

- ◆ Set includes: 1/4 Cup, 1/3 Cup, 1/2 Cup, 1 Cup

ITEM	DESCRIPTION	UOM	CASE
MCP-4P	4-Pc Set	Set	12/48



## PLASTIC MEASURING CUP SET

- ◆ Set includes: 1/4 Cup, 1/3 Cup, 1/2 Cup, 1 Cup
- ◆ BPA-free

ITEM	DESCRIPTION	UOM	CASE
MCPP-4	4-Pc Set	Set	12/72

## ALUMINUM MEASURES

ITEM	DESCRIPTION	UOM	CASE
AM-05	1/2 Qt	Each	48
AM-1	1 Qt	Each	36
AM-2	2 Qt	Each	36
AM-4	4 Qt	Each	24

## STAINLESS STEEL MEASURING BOWLS

- ◆ With interior graduations

ITEM	DESCRIPTION	UOM	CASE
SMB-4	4 Cups	Each	48
SMB-6	6 Cups	Each	24
SMB-10	10 Cups	Each	24



## PIZZA PANS

PIZZA PANS ARE IN STOCK, CUSTOM ORDER NOT REQUIRED

### WIDE-RIM PIZZA PANS

- ◆ All-purpose wide-rim pan allows for baking and serving straight out of the oven
- ◆ Aluminum

ITEM	DESCRIPTION	UOM	CASE
◆ APZT-7	7"	Each	36/72
◆ APZT-8	8"	Each	36/144
◆ APZT-9	9"	Each	36/72
◆ APZT-10	10"	Each	36/72
◆ APZT-11	11"	Each	36/72
◆ APZT-12	12"	Each	36/72
◆ APZT-13	13"	Each	36/72
◆ APZT-14	14"	Each	24/48
◆ APZT-15	15"	Each	24/48
◆ APZT-16	16"	Each	24/48
◆ APZT-17	17"	Each	12/36
◆ APZT-18	18"	Each	12/36
◆ APZT-19	19"	Each	12/24
◆ APZT-20	20"	Each	12/24



APZT-SERIES

### COUPE-STYLE PIZZA PANS

- ◆ Ideal for baking and serving thin crust pizzas
- ◆ Aluminum

ITEM	DESCRIPTION	UOM	CASE
◆ APZC-8	8"	Each	36/144
◆ APZC-9	9"	Each	36/144
◆ APZC-10	10"	Each	36/72
◆ APZC-11	11"	Each	36/72
◆ APZC-12	12"	Each	36/72
◆ APZC-13	13"	Each	36/72
◆ APZC-14	14"	Each	24/48
◆ APZC-15	15"	Each	24/48
◆ APZC-16	16"	Each	24/48
◆ APZC-18	18"	Each	12/36



APZC-SERIES

### ALUMINUM TRAYS WITH NIBS

An essential to producing savory, crispy pizza crusts every time, trays with nibs raise the dough 1/8" above the surface to allow moisture to escape while baking.

ITEM	DESCRIPTION	UOM	CASE
◆ APZN-6	6"	Each	36/72
◆ APZN-8	8"	Each	36/72
◆ APZN-9	9"	Each	36/72
◆ APZN-10	10"	Each	36/72
◆ APZN-12	12"	Each	24/48
◆ APZN-14	14"	Each	24/48
◆ APZN-16	16"	Each	24/48
◆ APZN-18	18"	Each	12/24
◆ APZN-20	20"	Each	12/24



APZN-SERIES

### STACKABLE ALUMINUM PIZZA PANS

- ◆ 1-1/2" pan depth
- ◆ 1" clearance between pans when stacked

ITEM	DESCRIPTION	UOM	CASE
◆ APZK-0615	6"	Each	6/24
◆ APZK-0815	8"	Each	6/24
◆ APZK-1015	10"	Each	6/24
◆ APZK-1215	12"	Each	6/12
◆ APZK-1415	14"	Each	6/12
◆ APZK-1615	16"	Each	6/12



Stackable



APZK-1615

## PIZZA PANS



SPP-1218

SPP-1616



Durable heavyweight cold-rolled steel



HAC-162

SEE PAGE 165 FOR MORE PAN OPTIONS



## SICILIAN PIZZA PANS

A must-have for making traditional thick-and-chewy Sicilian pizzas.

- ◆ Tapered design and fully nesting
- ◆ Non-stick coating provides even-heat transfer
- ◆ Durable heavyweight cold-rolled steel

ITEM	DESCRIPTION	UOM	CASE
SPP-1218	12"L x 18"W x 1"H	Each	12
SPP-1616	16"L x 16"W x 1"H	Each	12



## DEEP DISH PIZZA PANS

- ◆ Great for deep dish pizzas
- ◆ 1.0mm, 18 gauge hard anodized aluminum

ITEM	DESCRIPTION	UOM	CASE
HAC-082	8"Dia x 2"H	Each	6/24
HAC-102	10"Dia x 2"H	Each	6/24
HAC-122	12"Dia x 2"H	Each	6/24
HAC-142	14"Dia x 2"H	Each	6/24
HAC-162	16"Dia x 2"H	Each	6/12

## PERFORATED PIZZA DISKS



APZP-12P

PIZZA PANS ARE IN STOCK, CUSTOM ORDER NOT REQUIRED



APZP-12SP

## ALUMINUM PERFORATED DISKS

Perforated with 3/8" diameter holes, these pizza disks help to reduce cooking time and allow air circulation to achieve evenly baked crusts.

ITEM	DESCRIPTION	UOM	CASE
APZP-7P	7"Dia, 35 Holes	Each	36/144
APZP-8P	8"Dia, 43 Holes	Each	36/144
APZP-9P	9"Dia, 43 Holes	Each	36/144
APZP-10P	10"Dia, 67 Holes	Each	36/144
APZP-11P	11"Dia, 97 Holes	Each	36/144
APZP-12P	12"Dia, 97 Holes	Each	36/144
APZP-13P	13"Dia, 133 Holes	Each	36/72
APZP-14P	14"Dia, 133 Holes	Each	36/72
APZP-15P	15"Dia, 175 Holes	Each	36/72
APZP-16P	16"Dia, 175 Holes	Each	24/48
APZP-17P	17"Dia, 223 Holes	Each	36
APZP-18P	18"Dia, 223 Holes	Each	36
APZP-19P	19"Dia, 283 Holes	Each	36
APZP-20P	20"Dia, 349 Holes	Each	36

## ALUMINUM SUPER-PERFORATED DISKS

Perforated with more 3/8" diameter holes, these pizza disks reduce cooking time and allow air circulation to achieve evenly baked crusts.

- ◆ Nearly twice the amount of holes for faster cooking

ITEM	DESCRIPTION	UOM	CASE
APZP-7SP	7"Dia, 63 Holes	Each	36/144
APZP-8SP	8"Dia, 63 Holes	Each	36/144
APZP-9SP	9"Dia, 91 Holes	Each	36/144
APZP-10SP	10"Dia, 91 Holes	Each	36/144
APZP-11SP	11"Dia, 131 Holes	Each	36/144
APZP-12SP	12"Dia, 179 Holes	Each	36/144
APZP-13SP	13"Dia, 179 Holes	Each	36/72
APZP-14SP	14"Dia, 231 Holes	Each	36/72
APZP-15SP	15"Dia, 291 Holes	Each	36/72
APZP-16SP	16"Dia, 291 Holes	Each	24/48
APZP-17SP	17"Dia, 351 Holes	Each	36
APZP-18SP	18"Dia, 351 Holes	Each	36
APZP-19SP	19"Dia, 415 Holes	Each	36
APZP-20SP	20"Dia, 487 Holes	Each	36



### ALUMINUM PIZZA SCREENS

◆ Mesh bottom helps transfer heat to create a crispier crust

ITEM	DESCRIPTION	UOM	CASE
APZS-7	7"	Each	12/120
APZS-8	8"	Each	12/120
APZS-9	9"	Each	12/120
APZS-10	10"	Each	12/120
APZS-11	11"	Each	12/120
APZS-12	12"	Each	12/120
APZS-13	13"	Each	12/120
APZS-14	14"	Each	12/120
APZS-15	15"	Each	12/120
APZS-16	16"	Each	12/120
APZS-17	17"	Each	12/120
APZS-18	18"	Each	12/60
APZS-19	19"	Each	12/60
APZS-20	20"	Each	12/60

### ALUMINUM MEGA SCREENS

The ideal choice for conveyor oven use, these mega pizza screens are made of heavy-duty aluminum so they last up to ten times longer than standard screens.

ITEM	DESCRIPTION	UOM	CASE
AMS-7	7" Inner Dia, 7-3/4" Outer Dia	Each	12/144
AMS-8	8" Inner Dia, 8-1/4" Outer Dia	Each	12/144
AMS-9	9" Inner Dia, 9-3/4" Outer Dia	Each	12/144
AMS-10	10" Inner Dia, 10-3/4" Outer Dia	Each	12/72
AMS-11	11" Inner Dia, 11-3/4" Outer Dia	Each	12/72
AMS-12	12" Inner Dia, 12-3/4" Outer Dia	Each	12/72
AMS-13	13" Inner Dia, 13-3/4" Outer Dia	Each	12/72
AMS-14	14" Inner Dia, 14-3/4" Outer Dia	Each	12/48
AMS-15	15" Inner Dia, 15-3/4" Outer Dia	Each	12/48
AMS-16	16" Inner Dia, 16-3/4" Outer Dia	Each	12/48
AMS-17	17" Inner Dia, 17-3/4" Outer Dia	Each	12/36
AMS-18	18" Inner Dia, 18-3/4" Outer Dia	Each	12/36

### PIZZA SCREENS



APZS-7



PIZZA PANS ARE IN STOCK, CUSTOM ORDER NOT REQUIRED



AMS-8

### PIZZA PAN STAND

- ◆ Simple, attractive stand raises 6-1/2" above surface
- ◆ Ideal for tabletop with limited space

ITEM	DESCRIPTION	UOM	CASE
APZT-789	Chrome Plated Steel	Each	20

### PIZZA PAN RACK

- ◆ 1-5/8" spacing between each level
- ◆ Overall height is 27"
- ◆ Base measures 12" x 12"

ITEM	DESCRIPTION	UOM	CASE
APZT-1015	15 Tiers, Welded	Each	2

### STAND & RACK

NON-SLIP GRIP



APZT-789

IMPROVED STRUCTURE



APZT-1015

### PIZZA PAN GRIPPERS

ITEM	DESCRIPTION	UOM	CASE
PPG-8	Gripper for Deep Pizza Pans	Each	12/60
PPG-8A	Heavy-duty Cast Aluminum Gripper	Each	12/48
PPG-8S	Gripper for Shallow Pizza Pans	Each	6/60

### PIZZA PAN GRIPPERS

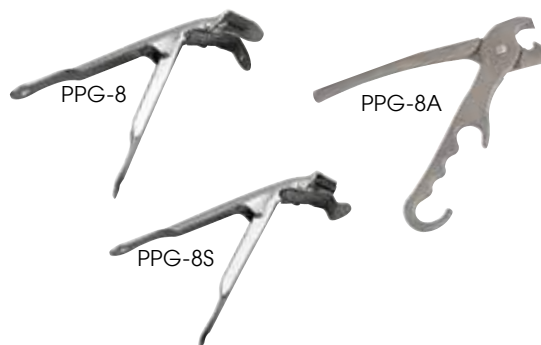

PPG-8

PPG-8A

PPG-8S

## BUBBLE POPPERS

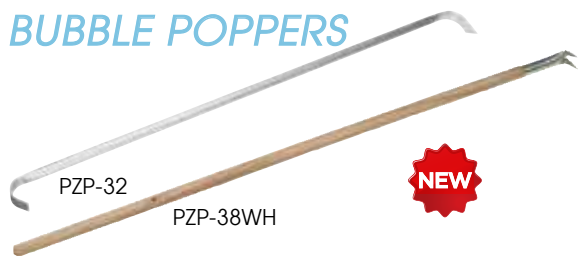

**NEW**

## PIZZA BUBBLE POPPERS

Say goodbye to unsightly pizza bubbles with pizza poppers, the long-reach tools that deflate dough bubbles while pizza is cooking in the oven.

ITEM	DESCRIPTION	O.L.	UOM	CASE
PZP-32	Aluminum	32"	Each	24/48
PZP-38WH	Wooden Handle	38"	Each	12/24

## PEELS



**NEW SIZES**

## ALUMINUM PIZZA/BURGER PEEL

◆ 14 gauge, 1.6mm thick

◆ 11"L handle

ITEM	DESCRIPTION	O.L.	UOM	CASE
APP-20	6-3/4" x 9" Blade	20"	Each	12/48

## ALUMINUM PIZZA PEELS

◆ Wooden handle

ITEM	DESCRIPTION	O.L.	UOM	CASE
APP-26	12" x 14" Blade	26"	Each	6/12
APP-36	12" x 14" Blade	36"	Each	6/12
APP-52	12" x 14" Blade	52"	Each	6/12
APP-10M	14" x 16" Blade	26"	Each	6/12
APP-18M	14" x 16" Blade	34"	Each	6/12
APP-18L	16" x 18" Blade	36"	Each	6/12



## WOODEN PIZZA PEELS

ITEM	DESCRIPTION	O.L.	UOM	CASE
WPP-1222	12" x 13" Blade	22"	Each	12
WPP-1236	12" x 13" Blade	36"	Each	12
WPP-1242	12" x 13" Blade	42"	Each	12
WPP-1424	14" x 15" Blade	24"	Each	12
WPP-1436	14" x 15" Blade	36"	Each	12
WPP-1442	14" x 15" Blade	42"	Each	12
WPP-1642	16" x 17-1/2" Blade	42"	Each	6
WPP-1842	18" x 19" Blade	42"	Each	6
WPP-2042	20" x 20" Blade	42"	Each	6

## PIZZA KNIVES & CUTTERS



## PIZZA CUTTERS

◆ NSF listed (Plastic handles)

ITEM	DESCRIPTION	BLADE	UOM	CASE
PWC-4	Wooden Handle	4" Dia	Each	12/72
PPC-2	Black PP Hdl, NSF	2-1/2" Dia	Each	12/72
PPC-4	Black PP Hdl, NSF	4" Dia	Each	12/72
PPC-2W	White Handle, NSF	2-1/2" Dia	Each	12/72
PPC-4W	White Handle, NSF	4" Dia	Each	12/72
VP-315	Small, Soft Grip Handle, NSF	2-1/2" Dia	Each	12/72
VP-316	Large, Soft Grip Handle, NSF	4" Dia	Each	12/72

**NSF** PPC & VP-SERIES

## PIZZA KNIVES

◆ NSF listed

ITEM	DESCRIPTION	UOM	CASE
KPP-18	18" Pizza Knife	Each	6/24
KPP-20	20" Pizza Rocker Knife	Each	6/24



**NSF** PIZZA KNIVES

**NSF** New Item

**PIZZA SERVER**

- ◆ Stainless steel
- ◆ Reinforced ergonomic PP handle
- ◆ NSF listed

ITEM	DESCRIPTION	UOM	CASE
TKP-62	6-7/8" x 5-7/8"	Each	6/24

**PIZZA SERVERS**



**PIZZA SERVING TONGS**

No more burnt hands/fingers with this sanitary solution for serving hot slices!

- ◆ 18/8 stainless steel
- ◆ Dishwasher Safe

ITEM	DESCRIPTION	UOM	CASE
PZG-6	5-1/2" x 4-1/2" Blade	Each	12/48



**ADJUSTABLE SHAKER DREDGE**

- ◆ 18/8 stainless steel mirror finish
- ◆ Features a three-way adjustable top with small, medium and large holes

ITEM	DESCRIPTION	UOM	CASE
DRG-8P	8 Oz	Each	12/96

**DREDGES**



**STAINLESS STEEL DREDGES**

ITEM	DESCRIPTION	UOM	CASE
DRG-10	10 Oz w/ Handle	Each	12/144
DRG-10H	10 Oz w/o Handle	Each	12/144
DRG-22H	22 Oz w/o Handle	Each	12/48

**ALUMINUM DREDGES**

ITEM	DESCRIPTION	UOM	CASE
ADRG-10	10 Oz w/ Handle	Each	12/144
ADRG-10H	10 Oz w/o Handle	Each	12/144

**PLASTIC DREDGE SETS**

- ◆ 10 oz polycarbonate dredge sets with snap-on lids
- ◆ NSF listed

ITEM	DESCRIPTION	UOM	CASE
PDG-10	3 Clear Lids	Set	48
PDG-10AC	4 Colored Lids	Set	48
PDG-10CS	10 Oz Dredge w/Clear S Lid	Set	12/48
PDG-10CM	10 Oz Dredge w/Clear M Lid	Set	12/48
PDG-10CL	10 Oz Dredge w/Clear L Lid	Set	12/48
PDG-10CXL	10 Oz Dredge w/Clear XL Lid	Set	12/48
PDG-10B	10 Oz Dredge w/Beige Lid	Set	12/48
PDG-10G	10 Oz Dredge w/Green Lid	Set	12/48
PDG-10R	10 Oz Dredge w/Rose Lid	Set	12/48
PDG-10Y	10 Oz Dredge w/Yellow Lid	Set	12/48



**PLASTIC COLORED DREDGE LIDS**

- ◆ Fits both PDG-10 and PDG-10AC dredges
- ◆ NSF listed

ITEM	DESCRIPTION	UOM	CASE
PDG-BL	Beige Lids, 6-Pcs/Pk	Pack	72/144
PDG-GL	Green Lids, 6-Pcs/Pk	Pack	72/144
PDG-RL	Rose Lids, 6-Pcs/Pk	Pack	72/144
PDG-YL	Yellow Lids, 6-Pcs/Pk	Pack	72/144



PDG-SERIES NSF

## DOUGH PREPARATION



ALDP-SERIES



PL-36NC

IMPROVED  
STRUCTURE



PL-3N

PL-6N

NEW  
IMPROVED

BPA  
FREE

PL-SERIES



DWR-2617



Transport dough boxes

NEW

## DOUGH RETARDING/PROOFING PANS & COVERS

- ◆ Stackable for easy storage
- ◆ Aluminum

ITEM	DESCRIPTION	UOM	CASE
ALDP-48	48 Oz, 7-7/8"Dia x 3"H	Each	12/24
ALDP-48C	Cover for ALDP-48	Each	120
ALDP-96	96 Oz, 8-3/4"Dia x 3"H	Each	12/24
ALDP-96C	Cover for ALDP-96	Each	120

## DOUGH BOXES & COVER

- ◆ Boxes stack tight to maintain freshness of contents
- ◆ Great for storing and proofing dough
- ◆ Reinforced structure resists breakage or bending over time
- ◆ Made of durable polypropylene
- ◆ BPA-free

ITEM	DESCRIPTION	UOM	CASE
PL-3N	25-5/8"L x 18"W x 3-1/4"H	Each	6
PL-6N	25-1/2"L x 17-1/2"W x 6"H	Each	3
PL-36NC	Cover	Each	12

Replaces PL-3, PL-6, PL-36C



Stackable



Reinforced edges & corners

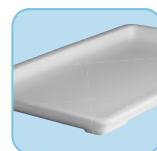

Lid can be used as a tray



Seamless fit for extra fresh storage needs

## WIRE DOUGH BOX DOLLY

Transport multiple dough boxes with ease using this wire dolly, currently the only one on the market!

- ◆ Capacity up to 400 Lbs
- ◆ Winco® exclusive
- ◆ Wheels measure 3-3/4" diameter each

ITEM	DESCRIPTION	UOM	CASE
DWR-2617	27"L x 18-1/4"W x 2-1/2"H	Each	1

## MIXING PADDLES



MPD-24



MPD-36



MPD-48



MPD-60

## STAINLESS STEEL MIXING PADDLES

ITEM	DESCRIPTION	UOM	CASE
MPD-24	24"	Each	12
MPD-36	36"	Each	12
MPD-48	48"	Each	12
MPD-60	60"	Each	12

### STAINLESS STEEL DOUGH SCRAPERS

ITEM	DESCRIPTION	SIZE (L X W)	UOM	CASE
DSC-1	Steel Handle	5-1/4" x 4-1/4"	Each	12/48
DSC-2	Plastic Handle, NSF	6" x 3"	Each	12/120
DSC-3	Wooden Handle	6" x 3"	Each	12/120

### DOUGH SCRAPERS



### PLASTIC DOUGH SCRAPERS

ITEM	DESCRIPTION	SIZE (L X W)	UOM	CASE
PDS-7	Large, 6-Pcs/Pk	7-1/2" x 4-3/4"	Pack	24/48
PDS-5	Small, 12-Pcs/Pk	5-1/2" x 3-3/4"	Doz	21/42

### ALLERGEN-FREE DOUGH SCRAPERS

Solve the challenges of maintaining an allergen-aware kitchen! Improve customer dining experiences while raising the bar for food safety. Prevent cross-contaminating allergens with the extensive line of Allergen-Free tools by Winco®. Whether it's gluten, nuts or more, use this stand-out purple color to designate these dough scrapers as allergen-free.

ITEM	DESCRIPTION	SIZE (L X W)	UOM	CASE
DSC-2P	Dough Scraper, Plstc Hdl, S/S Blade	6" x 3"	Each	12/72
PDS-7P	Plastic Dough Scrapers, 6-Pcs/Pk	7-1/2" x 4-3/4"	Pack	24/48



### ALUMINUM ROLLING PINS

◆ 3-1/2" diameter

ITEM	DESCRIPTION	UOM	CASE
ARP-13	13"L	Each	6
ARP-15	15"L	Each	6
ARP-18	18"L	Each	6

### ROLLING PINS



### WOODEN ROLLING PINS

◆ 2-3/4" diameter

ITEM	DESCRIPTION	UOM	CASE
WRP-13	13"L	Each	12
WRP-15	15"L	Each	12
WRP-18	18"L	Each	12



### FRENCH WOODEN ROLLING PIN

◆ 1-3/16" diameter

ITEM	DESCRIPTION	UOM	CASE
WRP-20F	20" Tapered	Each	12/48

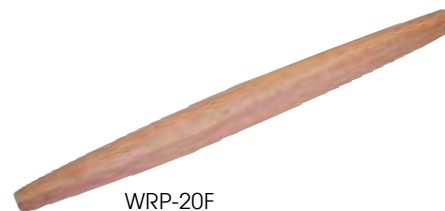

## DOUGH DIVIDERS & DOCKERS

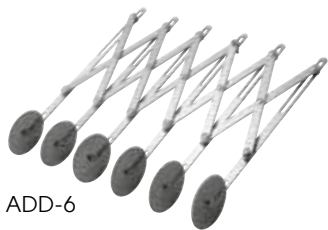

ADD-6

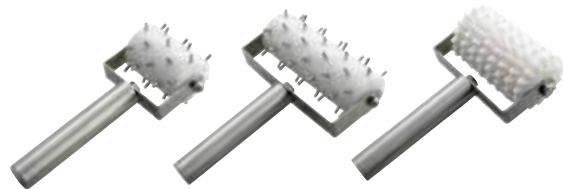

RD-2

RD-5

RD-8



RD-4P

RD-5P

### DOUGH DIVIDERS WITH ADJUSTABLE WHEELS

- ◆ Stainless steel wheels adjustable from 3/4" to approximately 4-3/4" for ADD-6 and 4-3/8" for ADD-5

ITEM	DESCRIPTION	UOM	CASE
ADD-5	5-Wheel	Each	36
ADD-6	6-Wheel	Each	36

### DOUGH ROLLER DOCKERS

- ◆ Stainless steel handle
- ◆ 8" Overall Length

ITEM	DESCRIPTION	UOM	CASE
RD-2	2-5/8"W Head	Each	24
RD-5	5"W Head	Each	24
RD-8	5"W Head, 8-Wheel	Each	24

### PLASTIC ROLLER DOCKERS

- ◆ 6 independently spinning wheels on the RD-4P
- ◆ Prevent bubbles from forming

ITEM	DESCRIPTION	UOM	CASE
RD-4P	4"W Head, Molded Ergonomic Handle	Each	24
RD-5P	5"W Head, Plastic Handle	Each	12/72

## ROTARY SIFTER



RFS-8

### ROTARY SIFTER

ITEM	DESCRIPTION	UOM	CASE
RFS-8	8 Cup, S/S	Each	12

## SPECIALTY TOOLS

NON-STICK



APHS-7

### ALUMINUM PIZZA HEAT SINK

Say goodbye to burnt crusts and undercooked pizza centers! Place this non-stick pizza heat sink in the center of your deep-dish pizza pies to evenly distribute heat and shorten baking time.

- ◆ Delivers heat to the center of the pizza to evenly bake deep dish and more
- ◆ Effectively shorten baking time
- ◆ 22 pins

ITEM	DESCRIPTION	UOM	CASE
APHS-7	6-3/4"Dia	Each	36



Distribute heat through thick centers

### DELIVERY BAGS

- ◆ Outer shell / liner: polyester, Filling: EPE
- ◆ Heat retention: 2 hours @ 167°F; 4 hours @ 131°F; 6 hours @ 95°F

ITEM	DESCRIPTION	UOM	CASE
BGDV-12	12" x 12" x 12"	Each	6
BGDV-22	22" x 22" x 12"	Each	6

### PIZZA BAGS



BGDV-SERIES

### PIZZA BAGS

- ◆ Outer shell / liner: polyester, Filling: EPE
- ◆ Insulated lining keeps food warm for longer periods of time

ITEM	DESCRIPTION	UOM	CASE
BGPZ-18	18" x 18" x 5"	Each	6
BGPZ-20	20" x 20" x 5"	Each	6
BGPZ-24	24" x 24" x 5"	Each	6

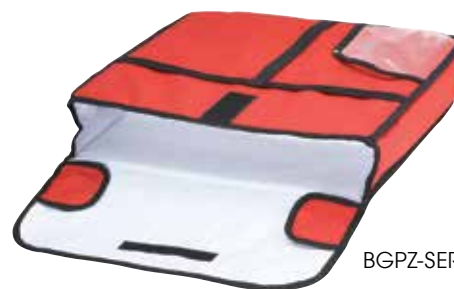

BGPZ-SERIES

### DUAL-HEADED BRUSH

- ◆ Thick brush has steel wire bristles trimmed to 40mm
- ◆ Thin brush has flat steel wire bristles trimmed to 30mm
- ◆ Replacement kit includes dual-head brush, bolt and nut



ITEM	DESCRIPTION	UOM	CASE
BR-21	Dual-Headed Brush with 28" S/S Handle	Each	6

### PIZZA OVEN BRUSHES



BR-21

### PIZZA OVEN/BROILER BRUSH

- ◆ Stiff stainless steel wire bristles make cleaning heavy oven residue effortless
- ◆ Quick and easy removal of heavy carbon deposits, rust and burned-on food buildup

ITEM	DESCRIPTION	UOM	CASE
BR-30	Brush with 30" Hd	Each	8/32

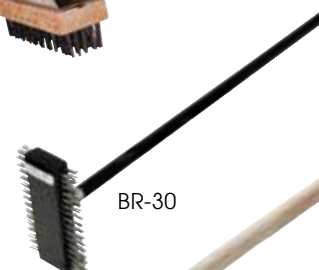

BR-30

### PIZZA OVEN SCRAPER

- ◆ Carbon wire brush and scraper

ITEM	DESCRIPTION	UOM	CASE
BR-27	Scraper with 27" Hd	Each	12



BR-27

### PIZZA OVEN BRUSH HEAD

- ◆ Brass bristles with scraper

ITEM	DESCRIPTION	UOM	CASE
BR-10	Brush Head, 10-1/4" x 1-3/8" x 1-3/4"	Each	12/48
BR-36W	36" Wooden Hd for BR-10	Each	48
BR-60W	55" Wooden Hd For BR-10	Each	6/24



BR-10



BR-36W

BR-60W



## KATTEX FRENCH FRY CUTTER

**KATTEX**



HFC-375

Can be mounted to wall or counter

**NSF** HFC-SERIES



### QUICK-SLICE FRENCH FRY CUTTERS

- ◆ Short throw handle design for smooth cutting of potatoes into french fries
- ◆ Extremely durable cast iron body with stainless steel components
- ◆ Fixed counter or wall mount; removable with wall bracket (sold separately)
- ◆ Accessories to modify cut sizes and styles sold separately
- ◆ 3-3/8" x 3-3/8" cutting area

ITEM	DESCRIPTION	UOM	CASE
HFC-250	1/4" Cut French Fry Cutter	Set	1
HFC-375	3/8" Cut French Fry Cutter	Set	1
HFC-500	1/2" Cut French Fry Cutter	Set	1

### FRENCH FRY CUTTER ACCESSORIES

ITEM	DESCRIPTION	UOM	CASE
HFC-250R	1/4" Cut Replacement Blade	Set	48
HFC-375R	3/8" Cut Replacement Blade	Set	48
HFC-500R	1/2" Cut Replacement Blade	Set	48
HFC-250B	1/4" Cut Blade Assembly	Set	24
HFC-375B	3/8" Cut Blade Assembly	Set	24
HFC-500B	1/2" Cut Blade Assembly	Set	24
HFC-250K	Pusher Block for 1/4" and 1/2" Cut Blade	Each	24
HFC-375K	Pusher Block for 3/8" Cut Blade	Each	24
HFC-BK	Wall Bracket for HFC series	Each	12

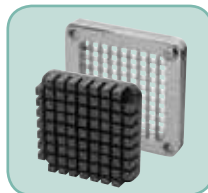

Replacement blades and blocks

## KATTEX TOMATO SLICERS

**KATTEX**



TTS-188

**NSF** TTS-SERIES



### TOMATO SLICERS

*With one quick push, smoothly and swiftly slice tomatoes with the stainless steel Kattex tomato slicer.*

- ◆ Aluminum frame with stainless steel replaceable blade
- ◆ Cuts 2 dozen tomatoes into 3/16" or 1/4" thick slices in 1 minute
- ◆ HDPE board ensures safe & durable food processing
- ◆ NSF listed

ITEM	DESCRIPTION	UOM	CASE
TTS-188	3/16" Blade	Set	4
TTS-188S	3/16" Serrated Blade	Set	4
TTS-250	1/4" Blade	Set	4
TTS-250S	1/4" Serrated Blade	Set	4

### TOMATO SLICER ACCESSORIES

ITEM	DESCRIPTION	UOM	CASE
TTS-188-B	3/16" Straight Blade Assembly for TTS-2 and TTS-188	Set	12
TTS-188S-B	3/16" Serrated Blade Assembly for TTS-2 and TTS-188	Set	12
TTS-250-B	1/4" Straight Blade Assembly for TTS-3 and TTS-250	Set	12
TTS-250S-B	1/4" Serrated Blade Assembly for TTS-3 and TTS-250	Set	12

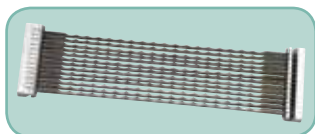

TTS-188S-B



## FRUIT & VEGETABLE SLICER

Save on time and labor with the Kattex Fruit & Vegetable Slicer by simply putting produce in a holder to turn out uniform slices in seconds.

- ◆ Aluminum construction with 9-1/4" stainless steel adjustable blade
- ◆ 1/16" to 1/2" slice thickness
- ◆ Mounts to countertops and other flat surfaces, can easily be removed for storage and cleaning
- ◆ Can accommodate fruits and vegetables with a maximum of 4" diameter and 5-1/2" in length

ITEM	DESCRIPTION	UOM	CASE
FVS-1	21"L x 10-3/4"W x 16"H	Each	2
FVS-1B	Replacement Blades, 2 pc	Set	10

## FRUIT WEDGE SLICERS

Get quick and perfect wedges of fruits for salad buffets with just a push of a handle. Ideal for core-less fruits, such as citrus, tomatoes and even potatoes.

- ◆ Aluminum construction with sharp stainless steel blades that minimize squeezing and bruising
- ◆ Sturdy base with non-skid feet
- ◆ 3-1/2" diameter cutting area
- ◆ NSF listed

ITEM	DESCRIPTION	UOM	CASE
FWS-6	6-Wedge	Each	4
FWS-8	8-Wedge	Each	4

## FRUIT WEDGE SLICER ACCESSORIES

ITEM	DESCRIPTION	UOM	CASE
FWS-6BK	6-Section Wedger & Blade Replacement for FWS-series	Set	10
FWS-8BK	8-Section Wedger & Blade Replacement for FWS-series	Set	10
FWS-6BC	6-Slice Apple Corer	Each	10
FWS-8BC	8-Slice Apple Corer	Each	10

## ONION SLICERS

Just one smooth stroke of the Kattex Onion Slicer will produce evenly sliced coins of fruits and vegetables for salads or cocktail drinks.

- ◆ Aluminum construction with stainless steel wire blades
- ◆ Unique lever-handle allows for quick and easy operation
- ◆ Sturdy base with non-skid feet
- ◆ Two blades included can be stacked to create a finer cut
- ◆ 4-1/2" x 3-3/4" cutting area
- ◆ NSF listed

ITEM	DESCRIPTION	UOM	CASE
OS-188	3/16" Blade Slicer	Each	2
OS-250	1/4" Blade Slicer	Each	2

## ONION SLICER ACCESSORIES

ITEM	DESCRIPTION	UOM	CASE
OS-188B	3/16" Blade Set Assembly for OS-series (2 pieces)	Set	10
OS-250B	1/4" Blade Set Assembly for OS-series (2 pieces)	Set	10

## KATTEX SLICERS

# KATTEX



# KATTEX



Replacement wedger and blade

FWS-SERIES NSF



# KATTEX

OS-SERIES NSF



Blade set assembly

KATTEX CHOPPER/DICER

**KATTEX**



HCD-250

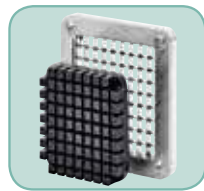

Replacement blade and block

**NSF** HCD-SERIES

**CHOPPERS/DICERS**

The Kattex Chopper/Dicer produces perfectly diced onions, tomatoes, potatoes and cucumbers too.

- ◆ Cast aluminum construction with stainless steel blades
- ◆ Sturdy base with non-skid feet
- ◆ 3-3/8" x 3-3/8" cutting area
- ◆ NSF listed

ITEM	DESCRIPTION	UOM	CASE
HCD-250	1/4" Blade Dicer	Each	4
HCD-375	3/8" Blade Dicer	Each	4
HCD-500	1/2" Blade Dicer	Each	4

**CHOPPER/DICER ACCESSORIES**

ITEM	DESCRIPTION	UOM	CASE
HCD-250BK	1/4" Replacement Blade & Block for HCD-series	Set	10
HCD-375BK	3/8" Replacement Blade & Block for HCD-series	Set	10
HCD-500BK	1/2" Replacement Blade & Block for HCD-series	Set	10

KATTEX LETTUCE CUTTER

**KATTEX**

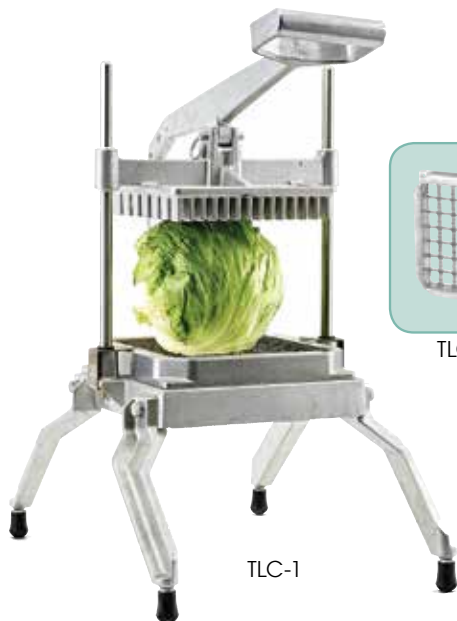

TLC-1

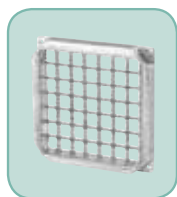

TLC-1-B

**LETTUCE CUTTER**

- ◆ Aluminum frame has easy-grip handle and stainless steel blade with 49-square cuts
- ◆ Cuts lettuce into 1" x 1" slices in less than 1 minute
- ◆ Rubber feet prevent slipping/scratching on work surface
- ◆ 7" x 7" cutting area

ITEM	DESCRIPTION	UOM	CASE
TLC-1	Lettuce Cutter	Each	2
TLC-1-B	Replacement Blade for TLC-1	Each	10

### PREMIUM MANUAL CAN OPENER

Our premium European-made heavy-duty nickel-plated can opener is fitted with a removable clamp, making it ideal for on-the-go operations that require flexibility. The rust-resistant stainless steel blade and gear opens various can sizes up to #10.

- ◆ Includes base, blade, gear and installation kit for mounting on wooden or stainless steel work tables

ITEM	DESCRIPTION	UOM	CASE
CO-3	Premium Manual Can Opener, Nickel Plated Steel Base	Each	12
CO-3B	1-Pc S/S Replacement Blade for CO-3	Each	1
CO-3G	1-Pc S/S Replacement Gear Set for CO-3	Each	1

### STANDARD #1 MANUAL CAN OPENER

The go-to industry standard steel body can opener, made for heavy usage kitchen environments that require processing of up to 50 cans a day. Opens various can sizes up to #10.

- ◆ Includes base, blade, gear and installation kit for mounting on wooden or stainless steel work tables
- ◆ The extra-durable blade and gears are interchangeable with most other can opener brands

ITEM	DESCRIPTION	UOM	CASE
CO-1	Manual Can Opener, Cast Iron Body	Set	1
CO-1B	2-Pc Replacement Blade Set for CO-1	Set	24/288
CO-1G	1-Pc Replacement Gear Set for CO-1	Each	12/144

### COMMERCIAL MANUAL CAN OPENERS



### FRENCH FRY CUTTERS

- ◆ Made of heavy-duty cast iron and fitted with sharp stainless steel blades for even slicing
- ◆ Ergonomic handles makes for easy operating and sturdy legs provide stability on flat countertop surfaces

ITEM	DESCRIPTION	UOM	CASE
FFC-250	1/4" Cut	Each	1
FFC-375	3/8" Cut	Each	1
FFC-500	1/2" Cut	Each	1

### FRENCH FRY CUTTERS



### FRENCH FRY CUTTER ACCESSORIES

ITEM	DESCRIPTION	UOM	CASE
FFC-250B	Blade Assembly for FFC-250	Each	24
FFC-250K	Pusher Block for FFC-250	Each	24
FFC-375B	Blade Assembly for FFC-375	Each	24
FFC-375K	Pusher Block for FFC-375	Each	24
FFC-500B	Blade Assembly for FFC-500	Each	24
FFC-500K	Pusher Block for FFC-500	Each	24
FFC-500P	Pusher Support for FFC-Series	Each	12



SCALES



**NEW**



SCAL-D20



**DIGITAL PORTION CONTROL SCALE**

Accurately weigh ingredients with measurements of either grams, pounds or ounces.

- ◆ Achieve consistency with portion control
- ◆ Ideal for quick-serve restaurant environment
- ◆ Removable stainless steel platform can be used as a tray
- ◆ Features auto-shutoff after three (3) minutes of inactivity
- ◆ Piece count, auto-zero and tare functions
- ◆ Battery and adapter included

ITEM	DESCRIPTION	CAPACITY	UOM	CASE
SCAL-D20	2-1/2 x 1" Digital Screen	20 Lb / 9 kg	Each	6



**PREMIUM KITCHEN SCALES**

- ◆ Heavy-duty stainless steel mechanical scale with 8" platform
- ◆ Shatter-proof lens protects dial
- ◆ Durable, corrosion-resistant

ITEM	DESCRIPTION	CAPACITY	GRADATIONS	UOM	CASE
SCLH-2	8" Dial	32 Oz	1/8 Oz / 10 g	Each	4
SCLH-50	8" Dial	50 Lb	1/8 Lb / 500 g	Each	4



**RECEIVING SCALES**

- ◆ Sturdy construction with large steel platforms
- ◆ 8" and 9" scales are calibrated to Lbs as the base measurement

ITEM	DESCRIPTION	CAPACITY	GRADATIONS	UOM	CASE
SCAL-62	6.5" Dial	2 Lb / 1 kg	1/4 Oz / 5 g	Each	8
SCAL-66	6.5" Dial	6 Lb / 3 kg	1/2 Oz / 10 g	Each	8
SCAL-810	8" Dial	10 Lb / 4.55 kg	1 Oz / 25 g	Each	6
SCAL-820	8" Dial	20 Lb / 9.09 kg	1 Oz / 50 g	Each	6
SCAL-840	8" Dial	40 Lb / 18.18 kg	2 Oz / 100 g	Each	6
SCAL-960	9" Dial	60 Lb / 27.27 kg	4 Oz / 100 g	Each	2
SCAL-9100	9" Dial	100 Lb / 45.45 kg	4 Oz / 100 g	Each	2
SCAL-9130	9" Dial	130 Lb / 59.09 kg	8 Oz / 200 g	Each	2



SCLH-2

SCLH-50



SCAL-840

**SUPER-SIZE SALAD SPINNERS**



PLSP-5O



PLSP-5G



**SUPER-SIZE SALAD SPINNERS**

- ◆ Constructed of FDA approved PP and ABS plastic, these spinners are equipped with side handles for safe transporting
- ◆ Foldable solid handle and 6 non-skid feet
- ◆ 3 tiers with 2 removable tier dividers that allow for various capacity configurations
- ◆ Dry 6 to 8 heads of lettuce in one minute!

ITEM	DESCRIPTION	UOM	CASE
PLSP-5G	5 Gal, Green	Each	1
PLSP-5O	5 Gal, Orange	Each	1



Comes apart for easy cleaning

**BPA FREE**

PLSP-SERIES

**CONDIMENT DISPENSER**

*Ideal for busy bars, food stands, convenient stores, or fast-food service. Removable plastic inserts allow for easy cleaning.*

- ◆ Durable 18/8 stainless steel
- ◆ Heavy-duty pump ideal for high-volume restaurant environment
- ◆ Two (2) plastic inserts, each with 2 quart capacity
- ◆ Each pump full stroke draws out between 1 oz and 1-1/4 oz depending on viscosity
- ◆ Overall dimensions: 11"L x 8-3/4"W x 16"H

ITEM	DESCRIPTION	UOM	CASE
PKTS-2D	Condiment Dispenser with 2 Standard Pumps	Set	2
PKTS-PT01	Individual Pump with Lid	Each	1
PKTS-PT02	Replacement Plastic Jar	Each	1
PKTS-PT03	Stainless Steel Casing	Each	1



**CONDIMENT DISPENSER**



PKTS-2D

**TORTILLA PRESSES**

- ◆ Traditional press with excellent leverage
- ◆ Integrated handle allows for easy open and removal of corn and flour tortillas
- ◆ Great for making burritos, enchiladas and quesadillas

ITEM	DESCRIPTION	WEIGHT	UOM	CASE
TPC-8A	8"Dia, Aluminum, Non-Stick	1.52Lbs	Each	6/12
TPC-8C	8"Dia, Cast Iron	7.94Lbs	Each	4



**TORTILLA PRESSES**



NON-STICK TPC-8A

TPC-8C

**PASTA MAKER**

*This pasta maker rolls out fresh sheets for building lasagnas and raviolis, strands of fettuccine and ribbons of pappardelle, all at the desired thickness from 2mm to 6mm.*

- ◆ Heavyweight chrome-plated stainless steel
- ◆ Clamps onto table or countertop for secure operation

ITEM	DESCRIPTION	UOM	CASE
NPM-7	Roller Length 7"	Set	6

**PASTA MAKER**



NPM-7

## MANDOLINE SLICERS



Built-in blade system for MDL-18



MDL-18



MDL-BLD

MDL-HD

MDL-15



Built-in blade system for MDL-4P



MDL-4P

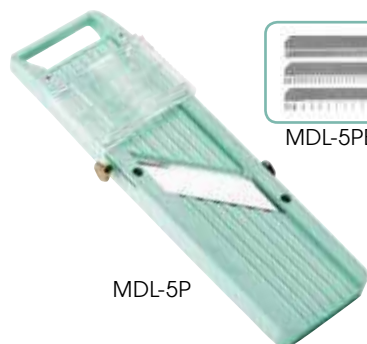

MDL-5P

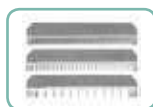

MDL-5PBC



### PREMIUM MANDOLINE SLICERS

- ◆ Rotary adjustment dial with 4 built-in blades for MDL-18
- ◆ Five (5) interchangeable blades for MDL-15
- ◆ Stainless steel body and handguard/food holder for each set

ITEM	DESCRIPTION	UOM	CASE
MDL-18	Mandoline Slicer Set, Built-in Blades	Set	8
MDL-15	Mandoline Slicer Set, Interchangeable Blades	Set	8
MDL-BLD	Blade Set for MDL-15	Set	12/48
MDL-HD	Hand Guard for MDL-15	Each	12/36

### MANDOLINE SLICER SET

- ◆ Built-in julienne blades, also includes a reversible slice and serrated blade
- ◆ Non-skid folding stand for compact storage
- ◆ Rotary adjustment dial
- ◆ Plastic body with rubberized non-slip grip handguard

ITEM	DESCRIPTION	UOM	CASE
MDL-4P	Mandoline Slicer Set	Set	8

### JAPANESE MANDOLINE SLICER SET

*Slice vegetables and fruits effortlessly! The built-in blade is adjustable to desired thickness, and comes with fine, medium & coarse attachment blades.*

- ◆ Professional blades provide clean and sharp cuts
- ◆ Great for carrots, onions, cucumbers and more
- ◆ Hand guard included for safety

ITEM	DESCRIPTION	UOM	CASE
MDL-5P	Japanese Mandoline Slicer Set	Set	36
MDL-5PBC	Blade Set for MDL-5P	Set	1

## FOOD CHOPPER



FCS-3

### FOOD CHOPPER

- ◆ 18/8 stainless steel construction with plastic base
- ◆ Zigzag-shaped blade rotates for dicing
- ◆ 0.5mm blade thickness

ITEM	DESCRIPTION	UOM	CASE
FCS-3	3"Dia	Each	6/24

## FOOD MILLS

A great alternative to using a food processor, the Winco® stainless steel food mills are ideal for straining and puréeing cooked fruits and vegetables without retaining seeds, skin and fibers. Simply turn the crank and the semi-circular blade sweeps over, compresses and scrapes the food.

### LARGE-SIZE FOOD MILL

- ◆ Comes with five (5) cutting plates allowing for a variety of textures
- ◆ The cutting plates are interchangeable with round perforations 8mm, 4mm, 3mm or 2mm dia, and 3 x 8.5mm rectangular grates
- ◆ Output is approximately 3 lbs per minute and fits on any 7" or larger receptacle

ITEM	DESCRIPTION	SIZE	UOM	CASE
SVM-12	5 Qt	12-3/4"Dia	Set	4



SVM-12



SVM-8



SVM-9

### MEDIUM-SIZE STAINLESS STEEL FOOD MILLS

ITEM	DESCRIPTION	SIZE	UOM	CASE
SVM-8	2 Qt w/4 Graters	8"Dia	Set	8
SVM-9	2 Qt w/3 Graters	9"Dia	Set	6

### APPLE PEELER

This apple peeler is about efficiency and volume. Turn the handle and it quickly peels, slices and cores apples all at the same time.

- ◆ Cast aluminum body with sharp stainless steel blade
- ◆ Vacuum base holds peeler securely to any smooth surface
- ◆ Also ideal for pears, onions and potatoes

ITEM	DESCRIPTION	UOM	CASE
AP-12	10"L x 6"W x 4-1/4"H	Set	12

## PEELER & SLICER



AP-12



### TURNING SLICER

- ◆ Have beautiful vegetable strands and curly ribbons in minutes with a turn of the handle
- ◆ Perfect for garnishing, cooking, and making salads and coleslaws
- ◆ Includes plastic turner, built-in straight blade and 3 interchangeable julienne blades

ITEM	DESCRIPTION	UOM	CASE
VTS-3G	11"L x 5"W x 7-3/8"H	Each	12
VTS-3GBS	Serrated Blade Set for VTS-3G, 3-Pc: Coarse, Medium, Fine	Set	1



VTS-3G



### MARBLE MORTAR & PESTLE SET

ITEM	DESCRIPTION	UOM	CASE
MPS-42W	4-1/2"Dia Bowl	Set	12

## MORTAR & PESTLE



MPS-42W

## STAINLESS STEEL MIXING BOWLS



MXHV-1600



MXBH-500



MXBT-1600Q



MXB-500Q



MXRU-SERIES



MXBS-30



SMB-SERIES

## HEAVY-DUTY MIXING BOWLS

ITEM	DESCRIPTION	SIZE (DIA X DEPTH)	UOM	CASE
MXHV-75	3/4 Qt	6-1/4" x 1-3/4"	Each	12/72
MXHV-150	1-1/2 Qt	7-3/4" x 2-1/4"	Each	12/36
MXHV-300	3 Qt	9-7/8" x 3"	Each	12/24
MXHV-400	4 Qt	10-5/8" x 3-1/4"	Each	12/24
MXHV-500	5 Qt	11-5/8" x 3-3/8"	Each	6/12
MXHV-800	8 Qt	13-3/4" x 5"	Each	6/12
MXHV-1300	13 Qt	16-1/4" x 4-1/2"	Each	12
MXHV-1600	16 Qt	17-3/4" x 5-1/2"	Each	12
MXHV-2000	20 Qt	18-3/4" x 5"	Each	12

## DEEP MIXING BOWLS

ITEM	DESCRIPTION	SIZE (DIA X DEPTH)	UOM	CASE
MXBH-300	3 Qt	9" x 3-1/2"	Each	12/48
MXBH-500	5 Qt	10-1/4" x 4-1/2"	Each	12/36
MXBH-800	8 Qt	12" x 5"	Each	12/24
MXBH-1300	13 Qt	15" x 5-3/4"	Each	12

## ALL-PURPOSE MIXING BOWLS

◆ True capacity for all-purpose kitchen prep work

ITEM	DESCRIPTION	SIZE (DIA X DEPTH)	UOM	CASE
MXBT-75Q	3/4 Qt	6-3/8" x 2-3/8"	Each	12/144
MXBT-150Q	1-1/2 Qt	7-7/8" x 2-7/8"	Each	12/144
MXBT-300Q	3 Qt	10-1/4" x 3-5/8"	Each	12/72
MXBT-400Q	4 Qt	11" x 3-3/4"	Each	12/72
MXBT-500Q	5 Qt	11-7/8" x 4"	Each	12/72
MXBT-800Q	8 Qt	13-3/4" x 5"	Each	12/36
MXBT-1300Q	13 Qt	16-3/8" x 5-7/8"	Each	12/24
MXBT-1600Q	16 Qt	17-7/8" x 6"	Each	12
MXBT-2000Q	20 Qt	19" x 6-5/8"	Each	12

## ECONOMY MIXING BOWLS

ITEM	DESCRIPTION	SIZE (DIA X DEPTH)	UOM	CASE
MXB-75Q	3/4 Qt	6-1/4" x 1-3/4"	Each	12/144
MXB-150Q	1-1/2 Qt	7-3/4" x 2-1/2"	Each	12/144
MXB-300Q	3 Qt	9-1/2" x 3-1/2"	Each	12/72
MXB-400Q	4 Qt	10-5/8" x 3-1/2"	Each	12/72
MXB-500Q	5 Qt	11-1/2" x 3-1/2"	Each	12/72
MXB-800Q	8 Qt	13-1/4" x 4-1/8"	Each	12/36
MXB-1300Q	13 Qt	14-3/4" x 3-1/2"	Each	24
MXB-1600Q	16 Qt	17-3/4" x 5"	Each	12
MXB-2000Q	20 Qt	18-5/8" x 5-1/2"	Each	12
MXB-3000Q	30 Qt	22-1/2" x 7-1/2"	Each	12

## SILICONE BASE MIXING BOWLS

◆ Non-skid silicone base helps to keep bowl in place during mixing and prepping

ITEM	DESCRIPTION	SIZE (DIA X DEPTH)	UOM	CASE
MXRU-150	1-1/2 Qt	6-3/4" x 3-3/4"	Each	48
MXRU-300	3 Qt	8-1/2" x 4-3/8"	Each	24
MXRU-500	5 Qt	10-1/4" x 5-5/8"	Each	24
MXRU-800	8 Qt	11-3/4" x 6-1/2"	Each	6/12

## STAINLESS STEEL MEASURING BOWLS

◆ With interior graduations

ITEM	DESCRIPTION	UOM	CASE
SMB-4	4 Cups	Each	48
SMB-6	6 Cups	Each	24
SMB-10	10 Cups	Each	24

## MIXING BOWL STAND

ITEM	DESCRIPTION	UOM	CASE
MXBS-30	Stand for MXB-3000Q	Set	1
MXBS-30-C	Caster for MXBS-30	Each	4/24



### HEAVY-DUTY COLANDERS

- ◆ Use to wash or drain large fruits, vegetables, pastas & meats
- ◆ Medium-size holes allow water to flow freely
- ◆ Premium quality stainless steel, extra deep with a wide base
- ◆ Extra heavy-duty weight

ITEM	DESCRIPTION	SIZE (DIA X DEPTH)	UOM	CASE
SLO-11	11 Qt	15" x 7-1/2"	Each	1
SLO-16	16 Qt	16-1/2" x 7-1/2"	Each	1

### COLANDERS



SLO-16

### ALL-PURPOSE COLANDERS

- ◆ Stainless steel

ITEM	DESCRIPTION	SIZE (DIA X DEPTH)	UOM	CASE
COD-3	3 Qt	10" x 4"	Each	12/48
COD-5	5 Qt	11-5/8" x 4"	Each	24
COD-8	8 Qt	13-1/4" x 5-1/8"	Each	12
COD-14	14 Qt	16-1/4" x 5-7/8"	Each	12



COD-3

### CHINESE STYLE COLANDERS

- ◆ Stainless steel

ITEM	DESCRIPTION	SIZE (DIA X DEPTH)	UOM	CASE
CCOD-11L	Coarse	11-3/4" x 4"	Each	24
CCOD-13L	Coarse	14-1/8" x 4-3/4"	Each	24
CCOD-15L	Coarse	16-3/8" x 5-1/8"	Each	12
CCOD-11S	Fine	12" x 4"	Each	24
CCOD-13S	Fine	15" x 4-1/2"	Each	24
CCOD-15S	Fine	16-3/8" x 5-1/2"	Each	12



CCOD-15L



CCOD-11S

### COLANDERS WITH BASE

- ◆ Aluminum

ITEM	DESCRIPTION	SIZE (DIA X DEPTH)	UOM	CASE
ALO-8BH	8 Qt	12" x 5"	Each	6
ALO-11BH	11 Qt	15" x 5-3/4"	Each	6
ALO-16BH	16 Qt	16-1/2" x 7-1/8"	Each	4



ALO-16BH

### CHINESE-STYLE COLANDERS

- ◆ Aluminum

ITEM	DESCRIPTION	SIZE (DIA X DEPTH)	UOM	CASE
ALO-12	12 Qt	13-1/2" x 5-1/2"	Each	12
ALO-16	16 Qt	16" x 8"	Each	12
ALO-16H	16 Qt	16-1/8" x 8"	Each	6



ALO-12

NOW WITH HANDLES



NEW SIZE

ALO-16H

# THERMOMETERS

**NSF** TMT-SERIES

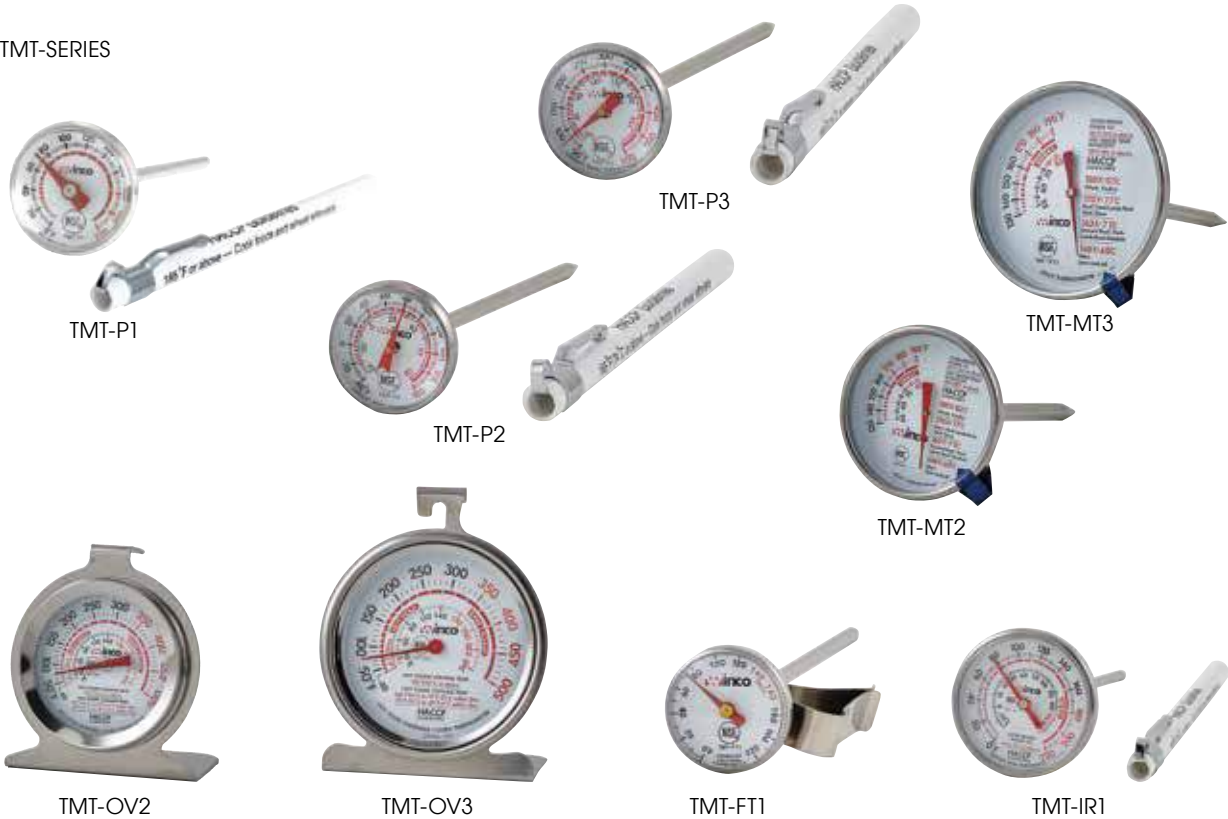

## POCKET TEST

- ◆ Built-in clip on the protective sleeve
- ◆ Comes with protective sheath

ITEM	NSF	TEMPERATURE RANGE	DIAL FACE SIZE	PROBE LENGTH	GUIDELINE ON DIAL	UOM	CASE
TMT-P1		0-220°F; -18-104°C	1" Dia	5"	HACCP	Each	12/72
TMT-P2		-40-180°F; -40-80°C	1" Dia	5"	HACCP	Each	12/72
TMT-P3		50-550°F; 10-288°C	1" Dia	5"	HACCP	Each	12/144

## MEAT

- ◆ Hand held thermometer
- ◆ Optional versions of the thermometer have adjustable indicators

ITEM	NSF	TEMPERATURE RANGE	DIAL FACE SIZE	PROBE LENGTH	GUIDELINE ON DIAL	UOM	CASE
TMT-MT2		130-190°F; 55-85°C	2" Dia	5"	HACCP	Each	12/144
TMT-MT3		130-190°F; 55-85°C	3" Dia	5"	HACCP	Each	12/72

## OVEN

- ◆ Hanging hook and standing panel are built-in

ITEM	NSF	TEMPERATURE RANGE	DIAL FACE SIZE	GUIDELINE ON DIAL	UOM	CASE
TMT-OV2		40-500°F; 10-260°C	2" Dia	HACCP	Each	12/144
TMT-OV3		40-500°F; 10-260°C	3" Dia	HACCP	Each	12/144

## FROTHING

- ◆ Includes pot clip
- ◆ Can be calibrated

ITEM	NSF	TEMPERATURE RANGE	DIAL FACE SIZE	PROBE LENGTH	OC AVAILABLE	UOM	CASE
TMT-FT1		0-220°F	1" Dia	5"	Optional	Each	12/144

## INSTANT READ

- ◆ Built-in clip on the protective sleeve
- ◆ Can be calibrated

ITEM	NSF	TEMPERATURE RANGE	DIAL FACE SIZE	PROBE LENGTH	GUIDELINE ON DIAL	UOM	CASE
TMT-IR1		0-220°F; -18-104°C	1-3/4" Dia	5"	HACCP	Each	12/72

TMT-SERIES  



TMT-DG6



TMT-GS2



TMT-CDF2

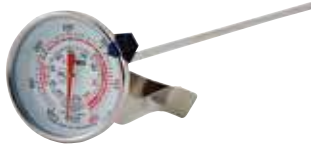

TMT-CDF3



TMT-CDF5



TMT-RF1



TMT-RF2



TMT-RF3



TMT-RF4



TMT-CDF4

**ROAST/MEAT**

- ◆ Programmable timer and temperatures
- ◆ Flip-down stand
- ◆ Magnet included

ITEM	NSF	TEMPERATURE RANGE	DIAL FACE SIZE	PROBE LENGTH	GUIDELINE ON DIAL	UOM	CASE
TMT-DG6		-58-572°F; -50-300°C	1-7/8" Digital LCD	6"		Set	24/96



**GRILL FACE**

- ◆ Flat surface for grill-top





ITEM	NSF	TEMPERATURE RANGE	DIAL FACE SIZE	UOM	CASE
TMT-GS2		150-700°F; 70-370°C	2" Dia	Each	3/144

**CANDY/DEEP FRYER**

- ◆ Pot clip included

ITEM	NSF	TEMPERATURE RANGE	DIAL FACE SIZE	PROBE LENGTH	GUIDELINE ON DIAL	OTHER FEATURES	UOM	CASE
TMT-CDF2		100-400°F; 40-200°C	2" Dia	5"	HACCP	Adjustable indicator	Each	12/144
TMT-CDF3		100-400°F; 40-200°C	2" Dia	12"	HACCP	Adjustable indicator	Each	12/144
TMT-CDF4		100-400°F; 40-200°C	2" x 11-3/4"	N/A	N/A	Top hanging	Each	12/72
TMT-CDF5		100-500°F; 40-260°C	3" Dia	12"	HACCP	Adjustable indicator	Each	6/36

**REFRIGERATOR/FREEZER**

ITEM	NSF	TEMPERATURE RANGE	DIAL FACE SIZE	GUIDELINE ON DIAL	MOUNTING	UOM	CASE
TMT-RF1		-26-86°F; -30-30°C	2-7/8" x 5/8"	N/A	Suction cup (included)	Pack	12/144
TMT-RF2		-20-70°F; -30-21°C	2" Dia	HACCP	Hanging hook & standing panel (built-in)	Each	12/72
TMT-RF3		-20-70°F; -30-21°C	3" Dia	HACCP	Hanging hook & standing panel (built-in)	Each	12/72
TMT-RF4		-20-80°F; -28-26°C	3-1/2" x 1-1/8"	HACCP	Suction cup (included)	Each	12/72

# THERMOMETERS

**NSF** TMT-SERIES



TMT-DG1



TMT-DG2

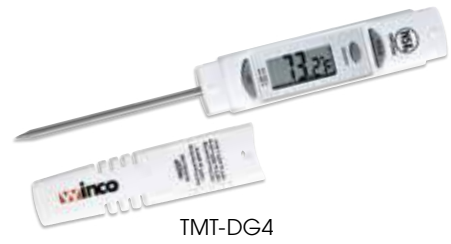

TMT-DG4



TMT-DG5



TMT-WD1



TMT-IF1

## DIGITAL

- ◆ Comes with protective sleeve
- ◆ Excellent, quick response times for fast temperature readings

ITEM	NSF	TEMPERATURE RANGE	DIAL FACE SIZE	PROBE LENGTH	GUIDELINE ON DIAL	MOUNTING / OTHER FEATURES	UOM	CASE
TMT-DG1		-40-302°F; -40-150°C	1" LCD (Diagonal)	4-3/4"	Meat Cooking Temperature Guide		Each	12/144
TMT-DG2		-49-392°F; -45-200°C	1-3/16" LCD	4-3/4"	Meat Cooking Temperature Guide	Head swivels 180 degrees for easy reading	Each	12/72
TMT-DG4		-40-450°F; -40-230°C	1-1/4" LCD	3-1/8"	HACCP	Hold function	Each	3/144
TMT-DG5		-49-392°F; -45-200°C	1-3/8" LCD with Back Light	2-7/8"	Meat Cooking Temperature Guide	<ul style="list-style-type: none"> <li>• Min &amp; max feature</li> <li>• Hold function</li> <li>• Hanging string</li> </ul>	Each	12/72

## WATERPROOF DIGITAL THERMOMETER

- ◆ Compact pen-style thermometer provides fast temperature readings for liquids or solids
- ◆ Minimum & maximum feature

ITEM	NSF	TEMPERATURE RANGE	DIAL FACE SIZE	PROBE LENGTH	GUIDELINE ON DIAL	MOUNTING / OTHER FEATURES	UOM	CASE
TMT-WD1		-58-392°F; -50-200°C	7/8" LCD	2-3/4"		<ul style="list-style-type: none"> <li>• Hold function</li> <li>• Includes protective sleeve</li> </ul>	Each	24/96

## INFRARED THERMOMETER

- ◆ Simply point infrared light at surface for accurate temperature reading of all kinds of cooked or baked goods, without the risk of cross-contamination.
- ◆ 20 second automatic power off
- ◆ Distance spot ratio 12:1

ITEM	NSF	TEMPERATURE RANGE	DIAL FACE SIZE	PROBE LENGTH	GUIDELINE ON DIAL	MOUNTING / OTHER FEATURES	UOM	CASE
TMT-IF1		-26°F-608°F; -32°C-320°C	1" LCD with Back Light	N/A		<ul style="list-style-type: none"> <li>• Auto temp. hold</li> <li>• Laser ON/OFF</li> </ul>	Each	12/48

## STAYGRIP CUTTING BOARDS

Say goodbye to traditional plastic cutting boards! Winco's rubberized "StayGrip" corners prevent slipping and sliding even on wet countertops. The patented built-in hanging hook is perfect for carrying and hygienic storage. Available in 3 popular sizes, HACCP color-coded and dishwasher safe.

- ◆ Patented built-in hanging hook for hygienic storage
- ◆ Fully rubberized grip hook for easy carrying
- ◆ Stay-put corner grips keep cutting board from sliding
- ◆ Available in 3 popular sizes
- ◆ HACCP color-coding system to prevent cross-contact
- ◆ Tough surface reduces knife dulling
- ◆ Durable co-polymer prevents warping
- ◆ Dishwasher safe
- ◆ NSF listed

ITEM	DESCRIPTION	COLOR	UOM	CASE
CBN-1218BN	12" x 18" x 1/2"	Brown	Each	6
CBN-1218BU	12" x 18" x 1/2"	Blue	Each	6
CBN-1218GR	12" x 18" x 1/2"	Green	Each	6
CBN-1218PP	12" x 18" x 1/2"	Purple	Each	6
CBN-1218RD	12" x 18" x 1/2"	Red	Each	6
CBN-1218WT	12" x 18" x 1/2"	White	Each	6
CBN-1218YL	12" x 18" x 1/2"	Yellow	Each	6
CBN-1520BN	15" x 20" x 1/2"	Brown	Each	6
CBN-1520BU	15" x 20" x 1/2"	Blue	Each	6
CBN-1520GR	15" x 20" x 1/2"	Green	Each	6
CBN-1520PP	15" x 20" x 1/2"	Purple	Each	6
CBN-1520RD	15" x 20" x 1/2"	Red	Each	6
CBN-1520WT	15" x 20" x 1/2"	White	Each	6
CBN-1520YL	15" x 20" x 1/2"	Yellow	Each	6
CBN-1824BN	18" x 24" x 1/2"	Brown	Each	6
CBN-1824BU	18" x 24" x 1/2"	Blue	Each	6
CBN-1824GR	18" x 24" x 1/2"	Green	Each	6
CBN-1824PP	18" x 24" x 1/2"	Purple	Each	6
CBN-1824RD	18" x 24" x 1/2"	Red	Each	6
CBN-1824WT	18" x 24" x 1/2"	White	Each	6
CBN-1824YL	18" x 24" x 1/2"	Yellow	Each	6

## STAYGRIP CUTTING BOARDS



# STAYGRIP



NSF

CBN-SERIES

BPA FREE

PATENTED

## CUTTING BOARDS & MATS

NSF

BPA FREE

CBWT-SERIES



NSF

BPA FREE

CBI-SERIES



CBI-1520

NSF

BPA FREE

CBF-SERIES



WCB-1824



WCB-125



### WHITE RECTANGULAR CUTTING BOARDS

◆ NSF listed

ITEM	DESCRIPTION	UOM	CASE
CBWT-610	6" x 10" x 1/2"	Each	20
CBWT-1218	12" x 18" x 1/2"	Each	6
CBWT-1520	15" x 20" x 1/2"	Each	6
CBWT-1824	18" x 24" x 1/2"	Each	6
CBWT-1830	18" x 30" x 1/2"	Each	6
CBH-1218	12" x 18" x 3/4"	Each	6
CBH-1520	15" x 20" x 3/4"	Each	6
CBH-1824	18" x 24" x 3/4"	Each	6
CBXH-1218	12" x 18" x 1"	Each	4
CBXH-1520	15" x 20" x 1"	Each	4
CBXH-1824	18" x 24" x 1"	Each	4



### WHITE GROOVED CUTTING BOARDS

◆ Higher efficiency in food prep without worrying about juice spillage

◆ NSF listed

ITEM	DESCRIPTION	UOM	CASE
CBI-1218	12" x 18" x 1/2"	Each	6
CBI-1520	15" x 20" x 1/2"	Each	6
CBI-1824	18" x 24" x 1/2"	Each	6
CBI-1824H	18" x 24" x 3/4"	Each	6



### WHITE FLEXIBLE CUTTING MATS

◆ Mat flexes to easily transport food to cookware or storage

◆ 1/16" thick polyethylene; will not crack or chip

◆ Safe, hygienic and easy to clean

◆ NSF listed

ITEM	DESCRIPTION	UOM	CASE
CBF-1218W	12" x 18", 6-Pcs/Set	Set	12
CBF-1520W	15" x 20", 6-Pcs/Set	Set	12

*Keep away from open flame. Do not put hot pans on top of mats. Wash with warm soapy water.*

### WOODEN CUTTING BOARDS

◆ 1-3/4" thick durable hardwood

ITEM	DESCRIPTION	UOM	CASE
WCB-1218	12" x 18"	Each	2
WCB-1520	15" x 20"	Each	2
WCB-1824	18" x 24"	Each	1
WCB-1830	18" x 30"	Each	1

### WOODEN BREAD/CHEESE BOARD

ITEM	DESCRIPTION	UOM	CASE
WCB-125	12" x 5" x 3/4"	Each	24

## CUTTING BOARD RACKS



### CUTTING BOARD RACKS

◆ Fits cutting boards up to 1" thick

ITEM	DESCRIPTION	UOM	CASE
CB-6L	6 Slots, Chrome Plated	Each	6/12
CB-6K	6 Slots, Vinyl Coated	Each	10



CB-6K



CB-6L

### ALLERGEN-FREE COLOR-CODED CUTTING BOARD

Solve the challenges of maintaining an allergen-aware kitchen! Improve customer dining experiences & raise the bar for food safety. Prevent cross-contaminating allergens with the extensive line of Allergen-Free tools by Winco®. Whether it's gluten or nuts, use this stand-out purple color to designate the cutting board as allergen-free.

◆ NSF listed

ITEM	DESCRIPTION	COLOR	UOM	CASE
CBPP-1218	12" x 18" x 1/2"	Purple	Each	6

### CUTTING BOARDS & MATS



CBPP-1218

NSF

BPA FREE

### HAACP COLOR-CODED CUTTING BOARDS

◆ NSF listed

ITEM	DESCRIPTION	COLOR	UOM	CASE
CBBN-1218	12" x 18" x 1/2"	Brown	Each	6
CBBU-1218	12" x 18" x 1/2"	Blue	Each	6
CBGR-1218	12" x 18" x 1/2"	Green	Each	6
CBRD-1218	12" x 18" x 1/2"	Red	Each	6
CBYL-1218	12" x 18" x 1/2"	Yellow	Each	6
CBBN-1520	15" x 20" x 1/2"	Brown	Each	6
CBBU-1520	15" x 20" x 1/2"	Blue	Each	6
CBGR-1520	15" x 20" x 1/2"	Green	Each	6
CBRD-1520	15" x 20" x 1/2"	Red	Each	6
CBYL-1520	15" x 20" x 1/2"	Yellow	Each	6
CBBN-1824	18" x 24" x 1/2"	Brown	Each	6
CBBU-1824	18" x 24" x 1/2"	Blue	Each	6
CBGR-1824	18" x 24" x 1/2"	Green	Each	6
CBRD-1824	18" x 24" x 1/2"	Red	Each	6
CBYL-1824	18" x 24" x 1/2"	Yellow	Each	6



COLORED CUTTING BOARDS

NSF

BPA FREE

STANDARD COLOR CODING SYSTEM		
Raw Meats	Raw Poultry	Vegetable & Fruit
Bakery & Dairy	Cooked Meats	Seafood

### HAACP COLOR-CODED FLEXIBLE CUTTING MATS

- ◆ Mat flexes to easily transport food to cookware or storage
- ◆ Safe, easy to clean and complies with color coding standards for food preparation hygiene
- ◆ Made of 1/16" thick polyethylene; will not crack or chip
- ◆ Six (6) assorted colors included in set
- ◆ NSF listed

ITEM	DESCRIPTION	COLOR	UOM	CASE
CBF-1218	12" x 18"	Assorted	Set	12
CBF-1520	15" x 20"	Assorted	Set	12
CBF-1824	18" x 24"	Assorted	Set	6

Keep away from open flame. Do not put hot pans on top of mats. Wash with warm soapy water.



CBF-SERIES

NSF

BPA FREE

### HAACP COLOR-CODED CUTTING BOARD SETS

- ◆ Six (6) assorted colors included in set
- ◆ NSF listed

ITEM	DESCRIPTION	COLOR	UOM	CASE
CBST-1218	12" x 18" x 1/2"	Assorted	Set	1
CBST-1520	15" x 20" x 1/2"	Assorted	Set	1
CBST-1824	18" x 24" x 1/2"	Assorted	Set	1



CBST-SERIES

NSF

BPA FREE

### HAACP COLOR-CODED CUTTING BOARD BRUSHES

ITEM	DESCRIPTION	COLOR	UOM	CASE
CBR-WT	6-1/2"L x 2-1/2"W	White	Each	24/96
CBR-BN	6-1/2"L x 2-1/2"W	Brown	Each	24/96
CBR-BU	6-1/2"L x 2-1/2"W	Blue	Each	24/96
CBR-GR	6-1/2"L x 2-1/2"W	Green	Each	24/96
CBR-RD	6-1/2"L x 2-1/2"W	Red	Each	24/96
CBR-YL	6-1/2"L x 2-1/2"W	Yellow	Each	24/96

### CUTTING BOARD BRUSHES



CBR-SERIES

## BATTER DISPENSERS



APCD-6



APCD-6 & APCD-6R



APCD-6R



STN-3



SF-7



SF-7 & SF-7R

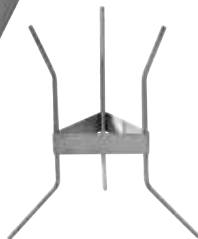

SF-7R



### ALUMINUM PANCAKE DISPENSER

- ◆ Durable plunger ensures consistent amounts of batter every time
- ◆ Eight portion-control settings ranging from 1/2 oz to 8 oz
- ◆ 10 gauge high-grade aluminum body
- ◆ Parts are durable, long-lasting, and prevent clogs and leaking

ITEM	DESCRIPTION	UOM	CASE
APCD-6	Pancake Dispenser	Each	6
APCD-6R	Rack for APCD-6	Each	12/48



### PANCAKE TURNER

- ◆ Heat resistant up to 608°F (320°C)
- ◆ Nylon blade
- ◆ 18/8 stainless steel handle

ITEM	DESCRIPTION	UOM	CASE
STN-3	15-7/16"L x 5-15/16"W x 2-13/16"H	Each	24/48

### CONFECTIONERY FUNNEL

- ◆ Use to dispense a smooth flow of fondant, syrup or prepared creams
- ◆ Spring valve feature allows for easy control with single-handed operation
- ◆ Comes with three (3) nozzles: 4mm, 5mm, 6mm
- ◆ Rack sold separately

ITEM	DESCRIPTION	UOM	CASE
SF-7	Funnel, S/S	Each	8
SF-7R	Rack for SF-7, S/S	Each	24

## UTILITY PAIL



UP-13

### UTILITY PAIL

- ◆ Stainless steel

ITEM	DESCRIPTION	UOM	CASE
UP-13	13 Qt	Each	12



# Allergen Free

FOR THE ALLERGEN-AWARE KITCHEN

## Raise the bar on food safety

Maintain the purity of your ingredients with Winco's extensive collection of Allergen-Free prep-tools, serveware, cutlery, storage containers and more.

**Purple** colored tools allow for quick and easy identification to prevent cross-contact and ensure allergen-safe food preparation. Safe-guard your guests with Allergen-Free!

### ALLERGEN-FREE PURPLE SILICONE BAKING MATS

- ◆ Double-sided and reusable up to 2,000 times
- ◆ Provides consistent and even heat distribution
- ◆ Woven fiberglass coated with food-grade silicone
- ◆ Temperature tolerance from -40°F to 540°F

ITEM	DESCRIPTION	SIZE	UOM	CASE
SBS-11PP	1/4-Size	8-1/4" x 11-3/4"	Each	20/100
SBS-16PP	1/2-Size	11-5/8" x 16-1/2"	Each	10/50
SBS-21PP	2/3-Size	14-7/16" x 20-1/2"	Each	10/50
SBS-24PP	Full-Size	16-3/8" x 24-1/2"	Each	10/50



SBS-21PP

### ALLERGEN-FREE DOUGH SCRAPERS

ITEM	DESCRIPTION	SIZE	UOM	CASE
DSC-2P	Dough Scraper, Plstc Hdl, S/S Blade	6" x 3"	Each	12/72
PDS-7P	Plastic Dough Scrapers, 6pcs/pk	7-1/2" x 4-3/4"	Pack	24/48



DSC-2P



PDS-7P



### ALLERGEN-FREE COLOR CODED SCRAPER

- ◆ Features raised ridges for resting to prevent messy counters
- ◆ Heat-resistant up to 600°F (315°C)

ITEM	DESCRIPTION	UOM	CASE
PSH-10P	10-1/2"	Each	24/144
PSH-14P	14"	Each	24/144
PSH-16P	16-1/4"	Each	24/144



PSH-16P

### ALLERGEN-FREE CUTTING BOARDS

Say good bye to traditional plastic cutting boards! Winco's rubberized StayGrip corners prevent slipping and sliding even on wet countertops. The patented built-in hanging hook is perfect for carrying and hygienic storage. Available in 3 popular sizes, HACCP color-coded and dishwasher safe.

- ◆ Patented built-in hanging hook for hygienic storage
- ◆ Fully rubberized grip hook for easy carrying
- ◆ Stay-put corner grips keep cutting board from sliding
- ◆ Available in 3 popular sizes
- ◆ HACCP color-coding system to prevent cross-contact
- ◆ Tough surface reduces knife dulling
- ◆ Durable co-polymer prevents warping
- ◆ Dishwasher safe
- ◆ NSF listed, BPA-free

ITEM	DESCRIPTION	COLOR	UOM	CASE
CBN-1218PP	12" x 18" x 1/2"	Purple	Each	6
CBN-1520PP	15" x 20" x 1/2"	Purple	Each	6
CBN-1824PP	18" x 24" x 1/2"	Purple	Each	6
CBPP-1218	12" x 18" x 1/2"	Purple	Each	6



CBN-1824PP

CBPP-1218

CUTTING BOARDS



**ALLERGEN-FREE KITCHEN TOOLS**



BFM-A100



PECC-128P, PECC-68P, PECC-24P

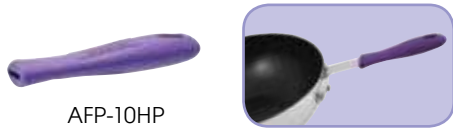

AFP-10HP

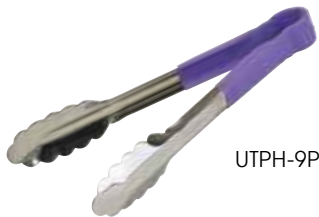

UTPH-9P



LDC-4P



FPS-4P

FPP-4P



ICD-16P

**NSF** ICD-SERIES



**ALLERGEN-FREE BAMBOO FOOD MARKERS**

- ◆ Label and organize dishes that contain no allergens
- ◆ Each pack contains 100 pieces

ITEM	DESCRIPTION	UOM	CASE
BFM-A100	Food Markers	Pack	20/200

**ALLERGEN-FREE COVERS**

- ◆ Compatible with PCSC, PTSC, and PESC Series

ITEM	DESCRIPTION	COLOR	UOM	CASE
PECC-24P	Fits 2 Qt & 4 Qt	Purple	Each	12
PECC-68P	Fits 6 Qt & 8 Qt	Purple	Each	12
PECC-128P	Fits 12 Qt, 18 Qt, 22 Qt	Purple	Each	6

**ALLERGEN-FREE SILICONE SLEEVE**

ITEM	DESCRIPTION	UOM	CASE
AFP-10HP	Purple Sleeve for AFP-10 series	Each	120

**ALLERGEN-FREE STAINLESS STEEL UTILITY TONGS**

- ◆ Non-slip comfort grip PP handle, heat resistant up to 220°F
- ◆ Made in Korea

ITEM	DESCRIPTION	UOM	CASE
UTPH-9P	9"	Each	6/72
UTPH-12P	12"	Each	6/72
UTPH-16P	16"	Each	6/72

**ALLERGEN-FREE STAINLESS STEEL ONE-PIECE LADLES**

ITEM	DESCRIPTION	HANDLE	UOM	CASE
LDC-2P	2 Oz	12-1/2"	Each	12/120
LDC-4P	4 Oz	15-1/2"	Each	12/120
LDC-6P	6 Oz	15-1/2"	Each	12/120

**ALLERGEN-FREE STAINLESS STEEL ONE-PIECE FOOD PORTIONERS**

ITEM	DESCRIPTION	UOM	CASE
FPS-2P	2 Oz, Solid	Each	12/72
FPS-4P	4 Oz, Solid	Each	12/72
FPS-6P	6 Oz, Solid	Each	12/72
FPP-2P	2 Oz, Perforated	Each	12/72
FPP-4P	4 Oz, Perforated	Each	12/72
FPP-6P	6 Oz, Perforated	Each	12/72



**ALLERGEN-FREE STAINLESS STEEL DISHERS**

- ◆ NSF listed

ITEM	DESCRIPTION	SIZE	UOM	CASE
ICD-10P	3-3/4 Oz, 2-5/8"Dia	10"	Each	36
ICD-12P	3-1/4 Oz, 2-1/2"Dia	12"	Each	36
ICD-16P	2-3/4 Oz, 2-1/4"Dia	16"	Each	36
ICD-20P	2 Oz, 2-1/8"Dia	20"	Each	36

ALLERGEN-FREE KITCHEN TOOLS



- ALLERGEN-FREE STAINLESS STEEL TURNERS & SPATULAS**
- ◆ Ergonomic handle with slip-free grip reduces hand fatigue
  - ◆ Satin finish
  - ◆ NSF listed

ITEM	DESCRIPTION	BLADE	UOM	CASE
TWP-31P	Sandwich Spreader	3-5/8" x 1-1/4"	Each	12/144
TWP-42P	Turner, Offset	8" x 4"	Each	12/48
TWP-51P	Pie Server, Offset *	4-5/8" x 2-3/8"	Each	12/72
TWP-60P	Fish Spatula	6-3/4" x 3-1/4"	Each	12/144
TWP-61P	Hamburger Turner, Offset*	5-1/8" x 2-7/8"	Each	12/72
TWP-90P	Flexible Turner, Offset*	8-1/4" x 2-7/8"	Each	12/48
TWP-91P	Perf Flex Turner, Offset*	8-1/4" x 2-7/8"	Each	12/48
TWPO-9P	Spatula, Offset*	8-1/2" x 1-1/2"	Each	12/72
TWPS-9P	Bakery Spatula	10" x 1-3/8"	Each	12/72

*\*Measurement reflects blade size not including offset*

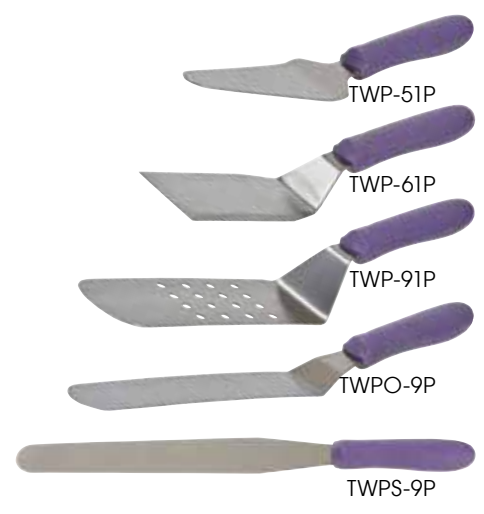

TWP, TWPO & TWPS-SERIES **NSF**

- ALLERGEN-FREE KNIVES**
- ◆ Razor-sharp blade constructed of X50 Cr MoV15 German steel
  - ◆ Slip-free grip ergonomic PP handle reduces hand fatigue
  - ◆ Protective finger guard
  - ◆ Easy edge maintenance and rapid sharpening
  - ◆ NSF listed

ITEM	DESCRIPTION	BLADE	UOM	CASE
KWP-30P	Paring Knife, 2-Pcs/Pk	3-1/4" L	Pack	6/36
KWP-80P	Chef's Knife	8" L	Each	6/36
KWP-91P	Bread Knife, Curved	9-1/2" L	Each	6/36
KWP-100P	Chef's Knife	10" L	Each	6/36
KWP-121P	Slicer, Wavy Edge	12" L	Each	6/36



KWP-SERIES **NSF**



PLATING MOLDS



CULINARY PASTRY MOLDS

Perfect for baking, freezing, cutting and forming, these ring molds are extremely versatile kitchen tools. Create attractive plate presentations by layering salads and grains, or bake individual cake and pastry portions without waste.

- ◆ Stainless steel
- ◆ Polished smooth to a brilliant mirror finish
- ◆ Dishwasher safe

ITEM	DESCRIPTION	UOM	CASE
SPM-21R	Round, 2"Dia x 1-3/4"H	Each	12/72
SPM-23R	Round, 2"Dia x 3"H	Each	12/72
SPM-31R	Round, 3"Dia x 1-3/4"H	Each	12/72
SPM-31O	Oval, 3"L x 1-3/8"H	Each	12/72
SPM-41O	Oval, 4"L x 1-3/8"H	Each	12/72
SPM-22S	Square, 2"L x 2"W x 2"H	Each	12/72
SPM-275S	Square, 2-3/4"L x 2-3/4"W x 2-3/4"H	Each	12/72
SPM-211T	Rectangular, 2-1/2"L x 1-3/4"W x 1-3/4"H	Each	12/72



**SAUCIER SPOON**

Easily create stylish and artistic plated foods with our tapered spout saucier spoons. The tapered end allows for control in drizzling and the deep bowl reduces the need to refill.

- ◆ Ideal for plating dessert, sauces, chocolate and more
- ◆ 18/8 stainless steel with satin finish
- ◆ Features a tapered spout and comfortable handle
- ◆ Dishwasher safe

ITEM	DESCRIPTION	UOM	CASE
SPS-TS8	8" Saucier w/ Tapered Spout	Each	6/72

**PLATING SPOONS**



SPS-TS8



**PLATING SPOONS**

Maintain excellent control in creating stylish presentations with these flat-front plating spoons, available w/ either a solid or perforated spoon bowl.

- ◆ Ideal for plating dessert, sauces, chocolate and more
- ◆ 18/8 stainless steel with satin finish
- ◆ Features a flat front and comfortable handle
- ◆ Dishwasher safe

ITEM	DESCRIPTION	UOM	CASE
SPS-S8	8" Slanted, Solid	Each	6/72
SPS-S10	10" Slanted, Solid	Each	6/72
SPS-P8	8" Slanted, Perforated	Each	6/72
SPS-P10	10" Slanted, Perforated	Each	6/72



SPS-S8



SPS-P8



**PLATING TONGS**

Plating tongs are the discerning chef's ideal tool, providing a controlled, gentle grasp of delicate garnishes for masterful placement and presentation.

- ◆ 18/8 stainless steel
- ◆ Dishwasher safe

ITEM	DESCRIPTION	UOM	CASE
TTG-8C	8" Curved	Each	24/144
TTG-10C	10" Curved	Each	24/144
TTG-8S	8" Straight	Each	24/144
TTG-10S	10" Straight	Each	24/144

**PLATING TONGS**



TTG-8C



TTG-10C



TTG-8S



TTG-10S





## Step up to Winco Prime® – A Cut Above

Winco Prime® products are made with industry approved materials that comply with or exceed accepted industry standards. All products in the Winco Prime® family are NSF® listed to give a comfort level that every effort has been made to provide a safe and durable product at an affordable price. Winco Prime® products are safe to be used and will hold up well in the most demanding food service environment!

### NSF® LADLES

AVAILABLE IN SUMMER 2017

NEW

LDCN-SERIES

NEW

LDCN-SERIES

NEW

LDIN-SERIES

#### ONE-PIECE COLOR-CODED HANDLE LADLES

- ◆ Color-coded for portion control
- ◆ Color matched with Winco Prime portioners and dishes

ITEM	DESCRIPTION	COLOR	UOM	CASE
LDCN-1	1 Oz	Black	Each	12/120
LDCN-2	2 Oz	Blue	Each	12/120
LDCN-3	3 Oz	Tan	Each	12/120
LDCN-4	4 Oz	Gray	Each	12/120
LDCN-6	6 Oz	Teal	Each	12/120
LDCN-8	8 Oz	Orange	Each	12/60

#### ONE-PIECE BLACK HANDLE LADLES

ITEM	DESCRIPTION	UOM	CASE
LDCN-1	1 Oz	Each	12/120
LDCN-2K	2 Oz	Each	12/120
LDCN-3K	3 Oz	Each	12/120
LDCN-4K	4 Oz	Each	12/120
LDCN-6K	6 Oz	Each	12/120
LDCN-8K	8 Oz	Each	12/60

#### ONE-PIECE STAINLESS STEEL LADLES

ITEM	DESCRIPTION	UOM	CASE
LDIN-0.5	0.5 Oz	Each	12/240
LDIN-0.75	0.75 Oz	Each	12/240
LDIN-1	1 Oz	Each	12/240
LDIN-1.5	1.5 Oz	Each	12/240
LDIN-2	2 Oz	Each	12/240
LDIN-3	3 Oz	Each	12/240
LDIN-4	4 Oz	Each	12/120
LDIN-5	5 Oz	Each	12/120
LDIN-6	6 Oz	Each	12/120
LDIN-8	8 Oz	Each	12/120
LDIN-12	12 Oz	Each	12/120

**ONE-PIECE STAINLESS STEEL LADLES**

ITEM	DESCRIPTION	HANDLE	UOM	CASE
LDI-0	0.5 Oz	10-1/4"	Each	12/240
LDI-1	1 Oz	10-3/8"	Each	12/240
LDI-1.5	1.5 Oz	10-1/8"	Each	12/120
LDI-2	2 Oz	10-1/2"	Each	12/240
LDI-3	3 Oz	11-1/8"	Each	12/120
LDI-4	4 Oz	12-1/4"	Each	12/120
LDI-5	5 Oz	12-1/2"	Each	12/120
LDI-6	6 Oz	12-1/2"	Each	12/120
LDI-8	8 Oz	12-1/2"	Each	12/120
LDI-12	12 Oz	12-3/4"	Each	12/120
LDI-16	16 Oz	11-1/2"	Each	12/120

**TWO-PIECE STAINLESS STEEL LADLES**

ITEM	DESCRIPTION	HANDLE	UOM	CASE
LDT-1	1 Oz	12"	Each	12/120
LDT-4	4 Oz	14"	Each	12/120
LDT-6	6 Oz	14"	Each	12/120
LDT-8	8 Oz	14"	Each	12/120
LDT-12	12 Oz	14"	Each	12/120
LDT-16	16 Oz	14"	Each	12/60
LDT-32	32 Oz	16"	Each	12/60

**STAINLESS STEEL SHORT HANDLE LADLES**

ITEM	DESCRIPTION	HANDLE	UOM	CASE
LDI-05SH	0.5 Oz, One-Pc	6"	Each	12/120
LDI-10SH	1 Oz, One-Pc	6"	Each	12/120
LDI-15SH	1.5 Oz, One-Pc	6"	Each	12/120
LDI-20SH	2 Oz, One-Pc	6"	Each	12/120
LDS-0	0.5 Oz, Two-Pc	8"	Each	12/120
LDS-1	1 Oz, Two-Pc	8"	Each	12/120
LDS-2	2 Oz, Two-Pc	8"	Each	12/120
LDS-3	3 Oz, Two-Pc	8"	Each	12/120
LDS-4	4 Oz, Two-Pc	8"	Each	12/120
LDS-6	6 Oz, Two-Pc	8"	Each	12/120

**ONE-PIECE STAINLESS STEEL COLOR-CODED LADLES**

ITEM	DESCRIPTION	HANDLE	UOM	CASE
LDC-05	0.5 Oz, Teal	12"	Each	12/120
LDC-1	1 Oz, Yellow	12"	Each	12/120
LDC-2	2 Oz, Red	12-1/2"	Each	12/120
LDC-3	3 Oz, Ivory	13"	Each	12/120
LDC-4	4 Oz, Green	15-1/2"	Each	12/120
LDC-6	6 Oz, Black	15-1/2"	Each	12/120
LDC-8	8 Oz, Blue	16-1/2"	Each	12/60
LDC-12	12 Oz, Gray	16-1/2"	Each	12/60

**MINI MEASURING LADLES**

Easily portion and serve smaller quantities with mini ladles in varying capacities.

- ◆ Ideal for either measuring or serving small quantities
- ◆ Durable stainless steel construction
- ◆ Capacity stamped on each handle

ITEM	DESCRIPTION	UOM	CASE
MSL-5S	5 Pc Set: 1/8 Tsp, 1/4 Tsp, 1/2 Tsp, 1 Tsp, 1 Tbsp	Set	12/72
MSL-11	3/4 Tbsp	Each	60/300

**STAINLESS STEEL HOOKED HANDLE DIPPER**

- ◆ Graduation marks visible on inside and outside

ITEM	DESCRIPTION	HANDLE	UOM	CASE
SHHD-1	1 Qt	12"	Each	12/48

**ALUMINUM TRANSFER DIPPER**

- ◆ Heavyweight and dent-resistant with 6-1/2" welded handle

ITEM	DESCRIPTION	HANDLE	UOM	CASE
ALD-30	30 Oz	6-1/2"	Each	12/48

**LADLES & PORTION CONTROLLERS**





## Step up to Winco Prime® – A Cut Above

Winco Prime® products are made with industry approved materials that comply with or exceed accepted industry standards. All products in the Winco Prime® family are NSF® listed to give a comfort level that every effort has been made to provide a safe and durable product at an affordable price. Winco Prime® products are safe to be used and will hold up well in the most demanding food service environment!

### NSF® PORTIONERS

AVAILABLE IN  
SUMMER 2017



**NEW** FPSN-SERIES



**NEW** FPPN-SERIES

The Winco Prime® family of products are NSF listed, an assurance that every effort has been made to provide a safe and durable product at an affordable price.

Count on Winco Prime®, products made to endure in the most demanding food service environment!

#### ONE-PIECE NSF STAINLESS STEEL PORTION CONTROLLERS

ITEM	DESCRIPTION	STYLE	COLOR	UOM	CASE
FPSN-1	1 Oz	Solid	Black	Each	12/72
FPSN-2	2 Oz	Solid	Blue	Each	12/72
FPSN-3	3 Oz	Solid	Tan	Each	12/72
FPSN-4	4 Oz	Solid	Gray	Each	12/72
FPSN-6	6 Oz	Solid	Teal	Each	12/72
FPSN-8	8 Oz	Solid	Orange	Each	12/72
FPPN-1	1 Oz	Perforated	Black	Each	12/72
FPPN-2	2 Oz	Perforated	Blue	Each	12/72
FPPN-3	3 Oz	Perforated	Tan	Each	12/72
FPPN-4	4 Oz	Perforated	Gray	Each	12/72
FPPN-6	6 Oz	Perforated	Teal	Each	12/72
FPPN-8	8 Oz	Perforated	Orange	Each	12/72



FPP & FPS-SERIES

#### ONE-PIECE STAINLESS STEEL PORTION CONTROLLERS

ITEM	DESCRIPTION	STYLE	COLOR	UOM	CASE
FPS-1	1 Oz	Solid	Yellow	Each	12/72
FPS-2	2 Oz	Solid	Red	Each	12/72
FPS-3	3 Oz	Solid	Ivory	Each	12/72
FPS-4	4 Oz	Solid	Green	Each	12/72
FPS-6	6 Oz	Solid	Black	Each	12/72
FPS-8	8 Oz	Solid	Blue	Each	12/72
FPP-1	1 Oz	Perforated	Yellow	Each	12/72
FPP-2	2 Oz	Perforated	Red	Each	12/72
FPP-3	3 Oz	Perforated	Ivory	Each	12/72
FPP-4	4 Oz	Perforated	Green	Each	12/72
FPP-6	6 Oz	Perforated	Black	Each	12/72
FPP-8	8 Oz	Perforated	Blue	Each	12/72





Step up to Winco Prime® – A Cut Above

**NSF® DISHERS**

**ONE-PIECE DELUXE DISHERS**

- ◆ Great for ice cream, mashed potatoes, etc.
- ◆ One-piece handle construction reinforced with S/S rod
- ◆ Sturdy, durable 18/8 stainless steel
- ◆ NSF listed

ITEM	DESCRIPTION	SIZE	COLOR	UOM	CASE
ICOP-6	5-1/2 Oz, 3"Dia	6	White	Each	36
ICOP-8	4 Oz, 2-3/4"Dia	8	Gray	Each	36
ICOP-10	3-1/4 Oz, 2-5/8"Dia	10	Ivory	Each	36
ICOP-12	2-2/3 Oz, 2-1/2"Dia	12	Green	Each	36
ICOP-16	2 Oz, 2-3/8"Dia	16	Blue	Each	36
ICOP-20	1-5/8 Oz, 2-1/4"Dia	20	Yellow	Each	36
ICOP-24	1-1/3 Oz, 2-1/16"Dia	24	Red	Each	36
ICOP-30	1 Oz, 1-13/16"Dia	30	Black	Each	36
ICOP-40	3/4 Oz, 1-5/8"Dia	40	Purple	Each	36



**DISHERS**

- ◆ 18/8 stainless steel
- ◆ NSF listed

ITEM	DESCRIPTION	SIZE	COLOR	UOM	CASE
ICD-6	4-2/3 Oz, 3"Dia	6	White	Each	36
ICD-8	4 Oz, 2-3/4"Dia	8	Gray	Each	36
ICD-10	3-3/4 Oz, 2-5/8"Dia	10	Ivory	Each	36
ICD-12	3-1/4 Oz, 2-1/2"Dia	12	Green	Each	36
ICD-16	2-3/4 Oz, 2-1/4"Dia	16	Blue	Each	36
ICD-20	2 Oz, 2-1/8"Dia	20	Yellow	Each	36
ICD-24	1-3/4 Oz, 2"Dia	24	Red	Each	36
ICD-30	1-1/4 Oz, 1-7/8"Dia	30	Black	Each	36
ICD-40	7/8 Oz, 1-5/8"Dia	40	Purple	Each	36



ICD-SERIES NSF

**DISHERS/PORCIONERS**

- ◆ 18/8 stainless steel

ITEM	DESCRIPTION	SIZE	UOM	CASE
ISS-8	4 Oz, 2-3/4"Dia	8	Each	12/48
ISS-10	3-3/4 Oz, 2-5/8"Dia	10	Each	12/48
ISS-12	3-1/4 Oz, 2-1/2"Dia	12	Each	12/48
ISS-16	2-3/4 Oz, 2-1/4"Dia	16	Each	12/48
ISS-20	2-1/2 Oz, 2-1/8"Dia	20	Each	12/48
ISS-24	1-3/4 Oz, 1-15/16"Dia	24	Each	12/48
ISS-30	1-1/4 Oz, 1-7/8"Dia	30	Each	12/48
ISS-40	7/8 Oz, 1-3/4"Dia	40	Each	12/48
ISS-50	5/8 Oz, 1-1/2"Dia	50	Each	12/48
ISS-60	9/16 Oz, 1-7/16"Dia	60	Each	12/48
ISS-70	1/2 Oz, 1-3/8"Dia	70	Each	12/48
ISS-100	3/8 Oz, 1-1/8"Dia	100	Each	12/48



ISS-SERIES

**ICE CREAM SCOOPERS, SELF-DEFROSTING**

- ◆ Cast aluminum, hand wash only
- ◆ Contains non-toxic heat conductive fluid that enables dipper to self-defrost

ITEM	DESCRIPTION	SIZE	UOM	CASE
AICD-12	3 Oz	12	Each	12/144
AICD-16	2-1/2 Oz	16	Each	12/144
AICD-20	2 Oz	20	Each	12/144
AICD-24	1-1/2 Oz	24	Each	12/144



AICD-12

**ICE CREAM SPADE**

ITEM	DESCRIPTION	UOM	CASE
ICS-1	Ice Cream Spade	Each	12/120



ICS-1



## Step up to Winco Prime® – A Cut Above

Winco Prime® products are made with industry approved materials that comply with or exceed accepted industry standards. All products in the Winco Prime® family are NSF® listed to give a comfort level that every effort has been made to provide a safe and durable product at an affordable price. Winco Prime® products are safe to be used and will hold up well in the most demanding food service environment!

### NSF® BASTING SPOONS

AVAILABLE IN  
SUMMER 2017



BSON

BSPN

BSSN



BHON

BHPN

BHSN

**NEW** BSON, BSPN, BSSN-SERIES

**NEW** BHON, BHPN, BHSN-SERIES

#### ONE-PIECE HEAVY-DUTY BASTING SPOONS

ITEM	DESCRIPTION	UOM	CASE
BSON-11	11" Solid	Each	12/144
BSON-13	13" Solid	Each	12/144
BSON-15	15" Solid	Each	12/144
BSON-18	18" Solid	Each	12/72
BSON-21	21" Solid	Each	12/72
BSPN-11	11" Perforated	Each	12/144
BSPN-13	13" Perforated	Each	12/144
BSPN-15	15" Perforated	Each	12/144
BSPN-18	18" Perforated	Each	12/72
BSSN-11	11" Slotted	Each	12/144
BSSN-13	13" Slotted	Each	12/144
BSSN-15	15" Slotted	Each	12/144
BSSN-18	18" Slotted	Each	12/72

#### BASTING SPOONS WITH STOP-HOOK ABS HANDLE

ITEM	DESCRIPTION	UOM	CASE
BHON-11	11" Solid	Each	12/120
BHON-13	13" Solid	Each	12/120
BHON-15	15" Solid	Each	12/120
BHPN-11	11" Perforated	Each	12/120
BHPN-13	13" Perforated	Each	12/120
BHPN-15	15" Perforated	Each	12/120
BHSN-11	11" Slotted	Each	12/120
BHSN-13	13" Slotted	Each	12/120
BHSN-15	15" Slotted	Each	12/120

### HEAVY-DUTY BASTING SPOONS

◆ 2.0mm thick stainless steel

ITEM	DESCRIPTION	UOM	CASE
BHKS-21	21" Solid	Each	6/48
BHKP-21	21" Perforated	Each	6/48

### ONE-PIECE HEAVY-DUTY BASTING SPOONS

◆ 1.5mm thick stainless steel

ITEM	DESCRIPTION	UOM	CASE
BSOT-11H	11" Solid	Each	12/144
BSOT-13H	13" Solid	Each	12/144
BSOT-15H	15" Solid	Each	12/144
BSOT-18	18" Solid	Each	12/72
BSOT-21	21" Solid	Each	12/72
BSPT-11H	11" Perforated	Each	12/144
BSPT-13H	13" Perforated	Each	12/144
BSPT-15H	15" Perforated	Each	12/144
BSPT-18	18" Perforated	Each	12/72
BSST-11H	11" Slotted	Each	12/144
BSST-13H	13" Slotted	Each	12/144
BSST-15H	15" Slotted	Each	12/144
BSST-18	18" Slotted	Each	12/72

### BASTING SPOONS

◆ 1.2mm thick stainless steel

ITEM	DESCRIPTION	UOM	CASE
BSOT-11	11" Solid	Each	12/144
BSOT-13	13" Solid	Each	12/144
BSOT-15	15" Solid	Each	12/144
BSPT-11	11" Perforated	Each	12/144
BSPT-13	13" Perforated	Each	12/144
BSPT-15	15" Perforated	Each	12/144
BSST-11	11" Slotted	Each	12/144
BSST-13	13" Slotted	Each	12/144
BSST-15	15" Slotted	Each	12/144

### BASTING FORKS

◆ 1.5mm thick stainless steel

ITEM	DESCRIPTION	UOM	CASE
BSFK-18	18"	Each	12/72
BSFK-21	21"	Each	12/72
BHKF-21	21", 2.0mm thick	Each	6/48

### BASTING SPOONS WITH PP HANDLE

◆ 1.2mm thick stainless steel

ITEM	DESCRIPTION	UOM	CASE
BSOB-11	11" Solid	Each	12/72
BSOB-13	13" Solid	Each	12/72
BSOB-15	15" Solid	Each	12/72
BSPB-11	11" Perforated	Each	12/72
BSPB-13	13" Perforated	Each	12/72
BSPB-15	15" Perforated	Each	12/72
BSSB-11	11" Slotted	Each	12/72
BSSB-13	13" Slotted	Each	12/72
BSSB-15	15" Slotted	Each	12/72

### BASTING SPOONS WITH STOP-HOOK PP HANDLE

◆ 1.2mm thick stainless steel

ITEM	DESCRIPTION	UOM	CASE
BHOP-11	11" Solid	Each	12/120
BHOP-13	13" Solid	Each	12/120
BHOP-15	15" Solid	Each	12/120
BHPP-11	11" Perforated	Each	12/120
BHPP-13	13" Perforated	Each	12/120
BHPP-15	15" Perforated	Each	12/120
BHSP-11	11" Slotted	Each	12/120
BHSP-13	13" Slotted	Each	12/120
BHSP-15	15" Slotted	Each	12/120

## BASTING UTENSILS



UTILITY TONGS



UTPH-SERIES

HEAT RESISTANT HEAVY-DUTY UTILITY TONGS

- ◆ Texturized non-slip PP handle for comfort and ease of use, heat resistant up to 220°F (104°C)
- ◆ Color-coded to help prevent cross-contamination in kitchen or buffet areas
- ◆ Made in Korea
- ◆ Stainless steel

ITEM	DESCRIPTION	COLOR	UOM	CASE
UTPH-9B	9"	Blue	Each	6/72
UTPH-9G	9"	Green	Each	6/72
UTPH-9K	9"	Black	Each	6/72
UTPH-9R	9"	Red	Each	6/72
UTPH-9Y	9"	Yellow	Each	6/72
UTPH-12B	12"	Blue	Each	6/72
UTPH-12G	12"	Green	Each	6/72
UTPH-12K	12"	Black	Each	6/72
UTPH-12R	12"	Red	Each	6/72
UTPH-12Y	12"	Yellow	Each	6/72
UTPH-16B	16"	Blue	Each	6/72
UTPH-16G	16"	Green	Each	6/72
UTPH-16K	16"	Black	Each	6/72
UTPH-16R	16"	Red	Each	6/72
UTPH-16Y	16"	Yellow	Each	6/72



UT-SERIES

Tongs for cold food service only

HEAVY-DUTY UTILITY TONGS WITH PLASTIC HANDLE

- ◆ For cold food service only
- ◆ Color-coded to help prevent cross-contact in kitchen or buffet areas
- ◆ Stainless steel

ITEM	DESCRIPTION	COLOR	UOM	CASE
UT-9HP-B	9"	Blue	Each	12/72
UT-9HP-G	9"	Green	Each	12/72
UT-9HP-K	9"	Black	Each	12/72
UT-9HP-R	9"	Red	Each	12/72
UT-9HP-Y	9"	Yellow	Each	12/72
UT-12HP-B	12"	Blue	Each	12/72
UT-12HP-G	12"	Green	Each	12/72
UT-12HP-K	12"	Black	Each	12/72
UT-12HP-R	12"	Red	Each	12/72
UT-12HP-Y	12"	Yellow	Each	12/72
UT-16HP-B	16"	Blue	Each	12/72
UT-16HP-G	16"	Green	Each	12/72
UT-16HP-K	16"	Black	Each	12/72
UT-16HP-R	16"	Red	Each	12/72
UT-16HP-Y	16"	Yellow	Each	12/72



UT-9HT

EXTRA HEAVYWEIGHT UTILITY TONGS

- ◆ Coiled spring
- ◆ 1.2mm thick stainless steel

ITEM	DESCRIPTION	UOM	CASE
UT-9HT	9"	Each	12/72
UT-12HT	12"	Each	12/72
UT-16HT	16"	Each	12/72



UT-9

HEAVYWEIGHT UTILITY TONGS

- ◆ Coiled spring
- ◆ 0.9mm thick stainless steel

ITEM	DESCRIPTION	UOM	CASE
UT-7	7" (Specially designed for table service)	Each	12/72
UT-9	9"	Each	12/72
UT-12	12"	Each	12/72
UT-16	16"	Each	12/72



UT-9LT

MEDIUM-WEIGHT UTILITY TONGS

- ◆ Coiled spring
- ◆ 0.6mm thick stainless steel

ITEM	DESCRIPTION	UOM	CASE
UT-9LT	9"	Each	12/72
UT-12LT	12"	Each	12/72
UT-16LT	16"	Each	12/72

With a locking clip and non-slip silicone grip and tips, these utility tongs are made to use on non-stick coated pans to prevent scratching.

## LOCKING TONGS

### SILICONE GRIP UTILITY TONGS

- ◆ 0.6mm thick stainless steel
- ◆ Heat-resistant up to 600 °F (315°C)

ITEM	DESCRIPTION	UOM	CASE
UTS-9K	9"	Each	12/72
UTS-12K	12"	Each	12/72



### UTILITY TONG

- ◆ 0.5mm thick stainless steel
- ◆ Locking ring and non-slip grip
- ◆ Heat-resistant up to 600 °F (315°C)

ITEM	DESCRIPTION	UOM	CASE
UT-7K	7"	Each	24/144



### HEAVYWEIGHT UTILITY TONGS WITH LOCKING RING

- ◆ Coil spring
- ◆ 0.9mm thick stainless steel

ITEM	DESCRIPTION	UOM	CASE
UTLK-7	7"	Each	12/72
UTLK-9	9"	Each	12/72
UTLK-12	12"	Each	12/72
UTLK-16	16"	Each	12/72



### SERVING TONGS

These heavyweight 18/8 satin finished stainless steel serving tongs are designed for comfortable service in elegant settings.

- ◆ Great for buffets, catered events and more
- ◆ Dishwasher safe

ITEM	DESCRIPTION	SIZE	UOM	CASE
STH-8	Short	8.5"	Each	12/72
STH-10	Medium	10.5"	Each	12/72
STH-13	Long	13.5"	Each	12/72

### SALAD TONGS

ITEM	DESCRIPTION	SIZE	UOM	CASE
PTOS-8	Oval, Satin Finish	7-3/4"	Each	12/96
ST-2	Double Spoon, Mirror Finish	10"	Each	6/60
ST-10	Fork and Spoon, Satin Finish	10"	Each	6/60
ST-10S	Slotted and Solid Spatula, Mirror Finish	10"	Each	12/96
ST-105SF	Spatula and Fork, Mirror Finish	10-1/2"	Each	12/96

### PASTRY TONGS

ITEM	DESCRIPTION	SIZE	UOM	CASE
PT-8	Solid with Short Handle	7-1/2"	Each	12/120
PT-875	Solid with Long Handle	8-3/4"	Each	12/144
PT-10P	Perforated	10-1/2"	Each	12/96

### SPAGHETTI TONGS

ITEM	DESCRIPTION	SIZE	UOM	CASE
ST-8	Mirror Finish	8"	Each	12/240

### ICE TONGS

ITEM	DESCRIPTION	SIZE	UOM	CASE
ICT-7	Five Prong, Textured	7"	Each	12/144
IT-7	Three Prong, Satin Finish	7"	Each	12/120

### POM TONGS

ITEM	DESCRIPTION	SIZE	UOM	CASE
PT-6	Satin Finish	6"	Doz	4/24
PT-9	Satin Finish	9"	Doz	4/24

## STAINLESS STEEL SERVING TONGS



**POLYCARBONATE  
SERVING UTENSILS**



**NSF** PUT-SERIES



PUTF-6K



**NSF** PPT-SERIES



PSSB-SERIES



**NSF** PSS-SERIES



**NSF** PLD-SERIES

**UTILITY TONGS**

ITEM	DESCRIPTION	SIZE	UOM	CASE
PUT-6B	Beige	6"	Each	12/192
PUT-6C	Clear	6"	Each	12/192
PUT-6K	Black	6"	Each	12/192
PUT-6R	Red	6"	Each	12/192
PUT-9B	Beige	9"	Each	12/144
PUT-9C	Clear	9"	Each	12/144
PUT-9K	Black	9"	Each	12/144
PUT-9R	Red	9"	Each	12/144
PUT-9W	White	9"	Each	12/144
PUT-12B	Beige	12"	Each	12/144
PUT-12C	Clear	12"	Each	12/144
PUT-12K	Black	12"	Each	12/144
PUT-12R	Red	12"	Each	12/144

**FLAT TONGS**

ITEM	DESCRIPTION	SIZE	UOM	CASE
PUTF-6B	Beige	6"	Each	12/432
<b>NSF</b> PUTF-6C	Clear, NSF	6"	Each	12/432
PUTF-6K	Black	6"	Each	12/432

**SPAGHETTI TONGS**

◆ Heat-resistant up to 302°F (150°C)

ITEM	DESCRIPTION	SIZE	UOM	CASE
PPT-11B	Beige	11"	Each	24/144
PPT-11C	Clear	11"	Each	24/144
PPT-11K	Black	11"	Each	24/144

**BUFFET SPOONS**

◆ 3/4 oz capacity

ITEM	DESCRIPTION	SIZE	UOM	CASE
PSSB-10B	Beige	10"	Each	12/384
<b>NSF</b> PSSB-10C	Clear, NSF	10"	Each	12/384
PSSB-10K	Black	10"	Each	12/384
PSSB-10R	Red	10"	Each	12/384

**SERVING SPOONS**

ITEM	DESCRIPTION	SIZE	UOM	CASE
PSS-13C	Clear	13"	Doz	12
PSS-13K	Black	13"	Doz	12
PSS-13R	Red	13"	Doz	12
PSS-15K	Black	15"	Doz	12

**ONE-PIECE LADLES**

ITEM	DESCRIPTION	CAPACITY	SIZE	UOM	CASE
PLD-8B	Beige	3/4 Oz	8-1/2"	Each	12/192
PLD-8C	Clear	3/4 Oz	8-1/2"	Each	12/192
PLD-8K	Black	3/4 Oz	8-1/2"	Each	12/192
PLD-8R	Red	3/4 Oz	8-1/2"	Each	12/192
PLD-13B	Beige	1 Oz	13"	Each	12/192
PLD-13C	Clear	1 Oz	13"	Each	12/192
PLD-13K	Black	1 Oz	13"	Each	12/192
PLD-13R	Red	1 Oz	13"	Each	12/192



### FRENCH WHIPS

◆ Stainless steel, NSF listed

ITEM	DESCRIPTION	UOM	CASE
FN-10	10"	Each	12/72
FN-12	12"	Each	12/72
FN-14	14"	Each	12/72
FN-16	16"	Each	12/60
FN-18	18"	Each	12/60
FN-20	20"	Each	12/60
FN-22	22"	Each	12/60
FN-24	24"	Each	12/60



### PIANO WHIPS

◆ Stainless steel, NSF listed

ITEM	DESCRIPTION	UOM	CASE
PN-10	10"	Each	12/72
PN-12	12"	Each	12/72
PN-14	14"	Each	12/72
PN-16	16"	Each	12/72
PN-18	18"	Each	12/72

### KETTLE & MAYONNAISE WHIPS

ITEM	DESCRIPTION	UOM	CASE
MWP-40	Mayonnaise Whip, 40"	Each	8
KWP-48	Kettle Whip, 48"	Each	8

### STAINLESS STEEL WHIPS



### PERFECT MASHER

*Our Connoisseur Perfect Masher effortlessly mashes, rices, and whips potatoes and vegetables in 60 seconds, allowing dishes to achieve the quality texture deserving of professional chefs.*

- ◆ Nine (9) diamond-shaped blades cut through food with ease, allowing greater control over food consistency
- ◆ Ergonomic rubberized handle for ease of use
- ◆ Dishwasher safe

ITEM	DESCRIPTION	UOM	CASE
PTMCO-9	9-Blade Masher	Each	6/24

### PLASTIC HANDLE POTATO MASHERS

*Our professional-quality mashers are nickel-plated, heavy-duty enough to be used for all root vegetables. The handles are chrome-plated for durability with a choice of polypropylene or wooden handles.*

ITEM	DESCRIPTION	SIZE	UOM	CASE
PTMP-18R	Round	4" x 18"	Each	6/12
PTMP-18S	Square	4-1/2" x 17-3/4"	Each	6/12
PTMP-24R	Round	5" x 24-1/2"	Each	6/12
PTMP-24S	Square	5-1/4" x 24"	Each	6/12

### WOODEN HANDLE POTATO MASHERS

ITEM	DESCRIPTION	SIZE	UOM	CASE
PTM-18R	4" Round	18" Handle	Each	6/12
PTM-18S	4-1/2" Square	17-3/4" Handle	Each	6/12
PTM-24R	5" Round	24-1/2" Handle	Each	6/12
PTM-24S	5-1/4" Square	24" Handle	Each	6/12

### POTATO RICERS

◆ Stainless steel

ITEM	DESCRIPTION	UOM	CASE
PR-9	Economy, Round	Each	6
PR-16	Square	Each	6

### MASHERS



PTMCO-9

Patented S/S diamond shape cutting blades

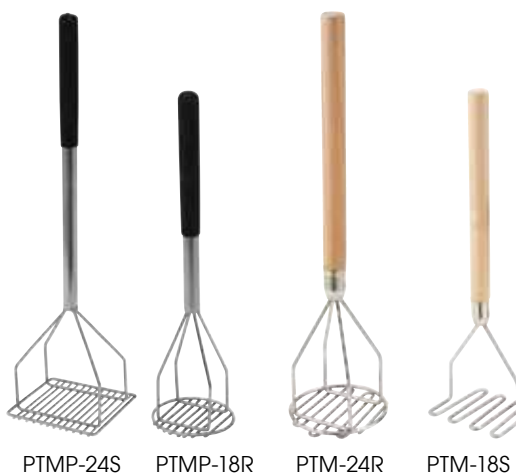

PTMP-24S

PTMP-18R

PTM-24R

PTM-18S



PR-9

PR-16



## COOKING TOOLS



### BLACK NYLON COOKING TOOLS

◆ Heat resistant up to 410°F (210°C)

ITEM	DESCRIPTION	UOM	CASE
NC-WS	A. Slotted Spatula	Each	12/144
NC-SL2	B. Slotted Spoon	Each	12/144
NC-SS1	C. Solid Spoon	Each	12/144
NC-PF2	D. 2-Prong Fork	Each	12/144
NC-PS1	E. Pasta Fork	Each	12/144
NC-RS	F. Fish Spatula	Each	12/144
NC-LD	G. Ladle	Each	12/144
NC-MS	H. Masher	Each	12/144
NC-SK	I. Skimmer	Each	12/144

### STAINLESS STEEL MIXING PADDLES

ITEM	DESCRIPTION	UOM	CASE
MPD-24	24"	Each	12
MPD-36	36"	Each	12
MPD-48	48"	Each	12
MPD-60	60"	Each	12

### WOODEN STIRRING PADDLES

ITEM	DESCRIPTION	UOM	CASE
WSP-18	18"	Each	4/36
WSP-24	24"	Each	4/36
WSP-36	36"	Each	4/36
WSP-48	48"	Each	4/36



### NYLON MIXING PADDLES

*Mix, fold or spread anything from icing to batters with this nylon mixing paddle. The stain-resistant, sturdy one-piece construction is resistant to high temperatures, making it ideal for melting chocolate on hot stove tops.*

- ◆ High temperature nylon is heat-resistant up to 425°F (220°C)
- ◆ BPA-free

ITEM	DESCRIPTION	UOM	CASE
NSP-10W	10"	Each	12/120
NSP-14W	14"	Each	12/120
NSP-20W	20"	Each	12/120



### NYLON SPOONS

- ◆ Easy to clean one-piece construction
- ◆ Ideal for non-stick cookware; Stain resistant
- ◆ Heat resistant up to 475°F (246°C)
- ◆ BPA-free

ITEM	DESCRIPTION	UOM	CASE
NS-12B	12", Blue	Each	24/144
NS-12R	12", Red	Each	24/144
NS-12T	12", Tan	Each	24/144
NS-12W	12", Off-white	Each	24/144
NS-15B	15", Blue	Each	24/72
NS-15R	15", Red	Each	24/72
NS-15T	15", Tan	Each	24/72
NS-15W	15", Off-white	Each	24/72



### WOODEN SPOONS

ITEM	DESCRIPTION	UOM	CASE
WWP-12	12"	Doz	8
WWP-14	14"	Doz	8
WWP-16	16"	Doz	8
WWP-18	18"	Doz	8



BPA FREE

NSP-SERIES

NEW COLOR



NS-15B

NEW COLOR



NS-15R



NS-15T



NS-15W

BPA FREE

NS-SERIES



WWP-SERIES



**ALLERGEN-FREE COLOR CODED SCRAPER**

Solve the challenges of maintaining an allergen-aware kitchen! Improve customer dining experiences while raising the bar for food safety. Prevent cross-contaminating allergens with the extensive line of Allergen-Free tools by Winco®. Whether it's gluten, nuts or more, use this stand-out purple color to designate these scrapers as allergen-free.

- ◆ Features raised ridges for resting to prevent messy counters
- ◆ Nylon handles heat-resistant up to 600°F (315°C)

ITEM	DESCRIPTION	UOM	CASE
PSH-10P	10-1/2"	Each	24/144
PSH-14P	14"	Each	24/144
PSH-16P	16-1/4"	Each	24/144

**SILICONE SCRAPERS**

- ◆ Features raised ridges for resting to prevent messy counters
- ◆ Nylon handles heat-resistant up to 600°F (315°C)

ITEM	DESCRIPTION	UOM	CASE
PSH-10	10-1/2"	Each	24/144
PSH-14	14"	Each	24/144
PSH-16	16-1/4"	Each	24/144

**BOWL-SHAPED SILICONE SCRAPERS**

- ◆ Heat-resistant up to 500°F (260°C)

ITEM	DESCRIPTION	UOM	CASE
PSG-10	10"	Each	12/120
PSG-14	14"	Each	12/120
PSG-16	16"	Each	12/120

**ECONOMY SILICONE SCRAPERS**

- ◆ Heat-resistant up to 500°F (260°C)

ITEM	DESCRIPTION	UOM	CASE
PSD-10	10"	Each	12/120
PSD-14	14"	Each	12/120
PSD-16	16"	Each	12/120

**BOWL-SHAPED PLASTIC SCRAPERS**

- ◆ BPA-free

ITEM	DESCRIPTION	UOM	CASE
PSGE-10	10"	Each	12/120
PSGE-14	14"	Each	12/72
PSGE-16	16"	Each	12/36

**PLASTIC SCRAPERS**

- ◆ BPA-free

ITEM	DESCRIPTION	UOM	CASE
PSC-10	10"	Each	24/360
PSC-14	14"	Each	12/288
PSC-16	16"	Each	12/288

**SCRAPERS**

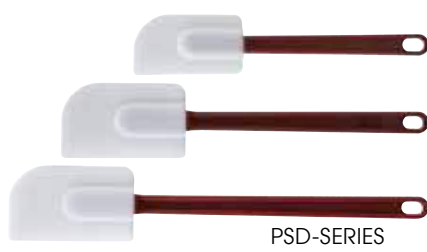
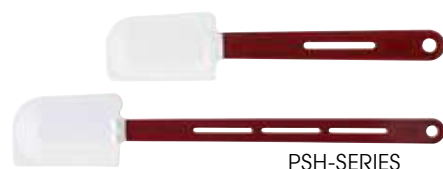

## MINI MEASURING LADLES

**NEW**

MSL-5S



**NEW**

MSL-11



## MINI MEASURING LADLES

Easily portion and serve smaller quantities with mini ladles in varying capacities.

- ◆ Ideal for either measuring or serving small quantities
- ◆ Durable 18/8 stainless steel construction
- ◆ Capacity stamped on each handle

ITEM	DESCRIPTION	UOM	CASE
MSL-5S	5-Pc Set: 1/8 Tsp, 1/4 Tsp, 1/2 Tsp, 1 Tsp, 1 Tbsp	Set	12/72
MSL-11	3/4 Tbsp	Each	60/300



## MEASURING SPOONS



MSP-4P



MSPD-4X



MSPP-4

**BPA FREE**

## STAINLESS STEEL MEASURING SPOON SETS

- ◆ Set includes: 1/4 Tsp, 1/2 Tsp, 1 Tsp, 1 Tbsp

ITEM	DESCRIPTION	UOM	CASE
MSP-4P	4-Pc Set	Set	12/288
MSPD-4X	Deluxe 4-Pc Set	Set	24/240

## PLASTIC MEASURING SPOON SET

- ◆ Set includes: 1/4 Tsp, 1/2 Tsp, 1 Tsp, 1 Tbsp
- ◆ BPA-free

ITEM	DESCRIPTION	UOM	CASE
MSPP-4	4-Pc Set	Set	12/216

## PLASTIC MEASURING CUPS



MCPP-4

**BPA FREE**

## PLASTIC MEASURING CUP SET

- ◆ Set includes: 1/4 Cup, 1/3 Cup, 1/2 Cup, 1 Cup
- ◆ BPA-free

ITEM	DESCRIPTION	UOM	CASE
MCPP-4	4-Pc Set	Set	12/72

**STAINLESS STEEL MEASURING CUP SET**

◆ Set includes: 1/4 Cup, 1/3 Cup, 1/2 Cup, 1 Cup

ITEM	DESCRIPTION	UOM	CASE
MCP-4P	4-Pc Set	Set	12/48

**STAINLESS STEEL MEASURING CUPS**



MCP-4P

**ALUMINUM MEASURES**

ITEM	DESCRIPTION	UOM	CASE
AM-05	1/2 Qt	Each	48
AM-1	1 Qt	Each	36
AM-2	2 Qt	Each	36
AM-4	4 Qt	Each	24

**ALUMINUM MEASURES**



AM-2

**DELUXE MEASURING CUPS**

- ◆ Molded one-piece break-resistant polycarbonate
- ◆ Raised external markings in both quarts (red letters) and liters (blue letters)
- ◆ Tapered open handle for a secure grip; stackable
- ◆ Dishwasher safe

ITEM	DESCRIPTION	UOM	CASE
PMCP-25	1 Cup	Each	6/72
PMCP-50	1 Pint	Each	6/72
PMCP-100	1 Qt	Each	6/36
PMCP-200	2 Qt	Each	6/36
PMCP-400	4 Qt	Each	6/24
PMCP-5SET	Complete 5-Pc Set	Set	6



**POLYCARBONATE MEASURING CUPS**



PMCP-SERIES NSF

**MEASURING CUPS**

- ◆ Durable polycarbonate w/raised graduation markings
- ◆ NSF listed

ITEM	DESCRIPTION	UOM	CASE
PMU-25	1 Cup	Each	36
PMU-50	1 Pint	Each	36
PMU-100	1 Qt	Each	36
PMU-200	2 Qt	Each	36
PMU-400	4 Qt	Each	12



PMU-SERIES NSF



# SPATULAS & TURNERS

- ◆ Stainless steel, satin finish blade
- ◆ Ergonomic handle with slip-free comfort grip reduces hand fatigue
- ◆ Dishwasher safe
- ◆ NSF listed (TNH-Series)

**HIGH-QUALITY  
LOW COST**



**NEW**



DESCRIPTION	BLADE SIZE (LxW)	UOM	HIGH-HEAT ORANGE NYLON ERGO HANDLE		WOODEN HANDLE	
			ITEM	CASE	ITEM	CASE
Mini Turner	2" x 2-1/4"	* Each			TN32	12/120
Sandwich Spreader	3-5/8" x 1-1/4"	Each			TN713	12/144
Small Scraper	4-1/2" x 3-1/8"	Each			TN526	12/72
Large Scraper	4-7/8" x 4"	Each			TN54	12/72
Steak/Burger Turner	4-1/8" x 3-3/4"	* Each			TN46	12/72
Turner	8" x 4"	Each	TNH-42	12/48	TN48	12/24
Grill Spatula	4-1/4" x 2-3/16"	* Each			TN165	12/72
Teppanyaki Turner, Full Tang	4" x 3-1/2"	* Each			TN43	12/72
Pie Server	4-5/8" x 2-3/8"	* Each			TN166	12/72
Fish Spatula	6-3/4" x 3-1/4"	Each	TNH-60	12/144	FST-6	12/144
Hamburger Turner	5-1/8" x 2-7/8"	* Each	TNH-61	12/72	TN719	12/72
Extra Heavy Turner, Cutting Edge Blade	5" x 6"	* Each	TNH-63	12/48	TN56	12/48
Square Edge Turner	6-1/4" x 3"	* Each	TNH-64	12/72		
Square Edge Turner	7-1/4" x 3"	* Each	TNH-70	12/48		
Flexible Turner	8-1/4" x 2-7/8"	* Each	TNH-90	12/48	TN249	12/72
Flexible Turner (Perforated Blade)	8-1/4" x 2-7/8"	* Each	TNH-91	12/48	TN409	12/72
Offset Giant Turner	8-1/2" x 2-7/8"	* Each			TN44	12/48
Offset Spatula	3-1/2" x 3/4"	* Each			TOS-4	24/288
Offset Spatula	6-1/2" x 1-5/16"	* Each			TOS-7	12/144
Offset Spatula	8-1/2" x 1-1/2"	* Each			TOS-9	12/72
Bakery Spatula	4" x 3/4"	Each			TNS-4	24/288
Bakery Spatula	7-15/16" x 1-1/4"	Each			TNS-7	12/144
Bakery Spatula	10" x 1-3/8"	Each			TNS-9	12/72

\*Measurement reflects blade size not including offset

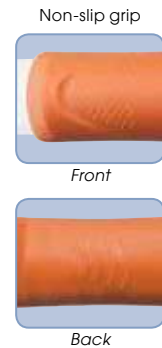
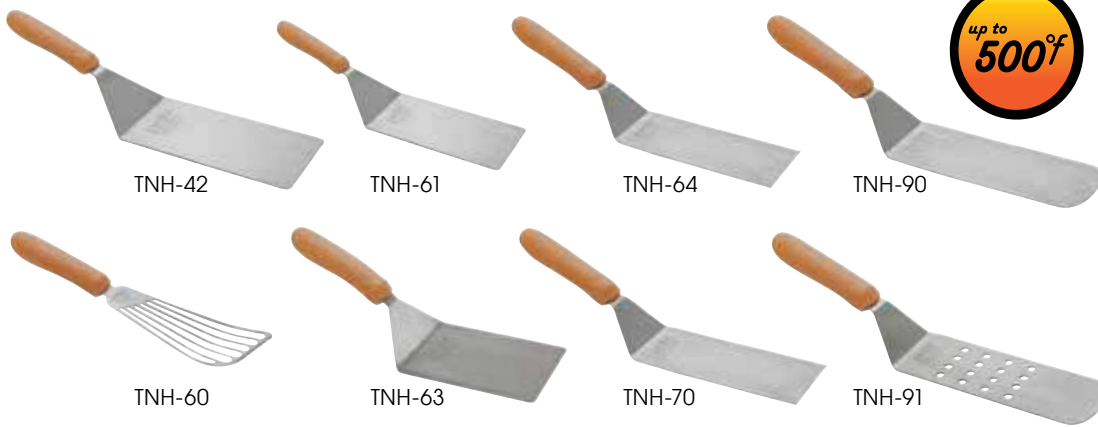

**NSF** TNH-SERIES (ORANGE)



Relative size comparisons shown

# SPATULAS & TURNERS

- ◆ Stainless steel, satin finish blade
- ◆ Ergonomic handle with slip-free comfort grip reduces hand fatigue
- ◆ Dishwasher safe
- ◆ NSF listed



DESCRIPTION	BLADE SIZE (L X W)	UOM	BLACK ERGO HANDLE		WHITE ERGO HANDLE	
			ITEM	CASE	ITEM	CASE
Mini Turner	2" x 2-1/4"	* Each	TKP-30	12/120	TWP-30	12/120
Sandwich Spreader	3-5/8" x 1-1/4"	Each	TKP-31	12/144	TWP-31	12/144
Small Scraper	4-1/2" x 3-1/8"	Each	TKP-32	12/72	TWP-32	12/72
Large Scraper	4-7/8" x 4"	Each	TKP-40	12/120	TWP-40	12/120
Steak/Burger Turner	4-1/8" x 3-3/4"	* Each	TKP-41	12/72	TWP-41	12/72
Turner	8" x 4"	Each	TKP-42	12/48	TWP-42	12/48
Grill Spatula	4-1/4" x 2-3/16"	* Each	TKP-50	12/72	TWP-50	12/72
Pie Server	4-5/8" x 2-3/8"	* Each	TKP-51	12/72	TWP-51	12/72
Fish Spatula	6-3/4" x 3-1/4"	Each	TKP-60	12/144	TWP-60	12/144
Hamburger Turner	5-1/8" x 2-7/8"	* Each	TKP-61	12/72	TWP-61	12/72
Extra Heavy Turner, Cutting Edge Blade	5" x 6"	* Each	TKP-63	12/48		
Flexible Turner	8-1/4" x 2-7/8"	* Each	TKP-90	12/72	TWP-90	12/48
Flexible Turner (Perforated Blade)	8-1/4" x 2-7/8"	* Each	TKP-91	12/72	TWP-91	12/48
Offset Spatula	3-1/2" x 3/4"	* Each	TKPO-4	24/288	TWPO-4	24/288
Offset Spatula	6-1/2" x 1-5/16"	* Each	TKPO-7	12/144	TWPO-7	12/144
Offset Spatula	8-1/2" x 1-1/2"	* Each	TKPO-9	12/144	TWPO-9	12/144
Bakery Spatula	4" x 3/4"	Each	TKPS-4	24/288	TWPS-4	24/288
Bakery Spatula	7-15/16" x 1-1/4"	Each	TKPS-7	12/144	TWPS-7	12/144
Bakery Spatula	10" x 1-3/8"	Each	TKPS-9	12/144	TWPS-9	12/144

\*Measurement reflects blade size not including offset



TKP-SERIES (BLACK) NSF

TWP-SERIES (WHITE) NSF

PASTA BASKETS



MPSP-69



MPF-57

MPF-59

MPF-67

The Connoisseur premium pasta baskets are made with 18/8 stainless steel that is electro-polished for added resistance to corrosion. The extra-heavyweight construction stands up to constant knocking of its edges when removing pasta. The cylindrical design allows water to flow freely for even cooking. The comfortable ergonomic handle has an open end for hang drying. The baskets can be used with most pasta cooker machines and standard stock pots.



**SINGLE PLY PERFORATED CONNOISSEUR PASTA BASKET**

- ◆ Designed for all pasta types
- ◆ 18/8 stainless steel, extra-heavyweight
- ◆ Electro-polished perforated stainless steel for added corrosion protection
- ◆ Durable frame handles extra-tough commercial kitchen use

ITEM	DESCRIPTION	UOM	CASE
MPSP-69	6-1/2"Dia x 9"H, Tall	Each	8



**SUPER FINE MESH CONNOISSEUR PASTA BASKETS**

- ◆ Designed specifically for fine pasta, such as capellini and linguine
- ◆ 18/8 stainless steel, with reinforced frame

ITEM	DESCRIPTION	UOM	CASE
MPF-57	5"Dia x 7"H, Short	Each	8
MPF-59	5"Dia x 9"H, Tall	Each	8
MPF-67	6-1/2"Dia x 7"H, Wide	Each	8

PASTA BOIL BASKETS



MPN-57

MPN-59

MPN-67

**PASTA BOIL BASKETS**

- ◆ 18/8 stainless steel frame and normal mesh makes it ideal for cooking capellini
- ◆ Fits standard pasta cookers and stock pots

ITEM	DESCRIPTION	UOM	CASE
MPN-57	5-1/4" Dia x 7"H, Short	Each	2/8
MPN-59	5" Dia x 9"H, Tall	Each	2/8
MPN-67	6-1/2" Dia x 7"H, Wide	Each	2/6

BULK PASTA BASKET

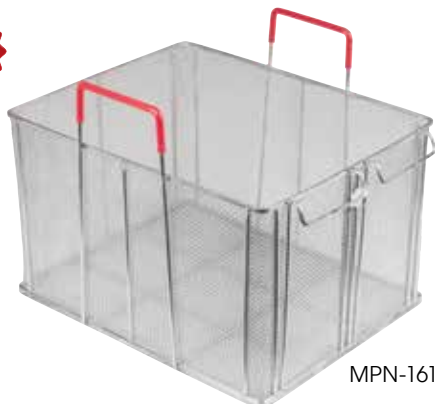

MPN-1613

**BULK PASTA/IMMERSION BASKET**

- ◆ Durable 18/8 stainless steel
- ◆ Plastic coated handles rated for temperatures up to 250°F (120°C)
- ◆ Suitable for cooking all types of pasta in bulk
- ◆ Fits standard cookers



ITEM	DESCRIPTION	UOM	CASE
MPN-1613	16-1/4"L x 12-7/8"W x 10"H	Each	2



### HOLLOW HANDLE BOUILLON STRAINERS

- ◆ Extra-fine mesh

ITEM	DESCRIPTION	UOM	CASE
CCB-8	8"	Each	6
CCB-8R	8", Reinforced	Each	6
CCB-10	10"	Each	6
CCB-10R	10", Reinforced	Each	6

Replaces former CCBH-Series

### CHINA CAP STRAINERS, STAINLESS STEEL

- ◆ Perforated 18/8 stainless steel with welded handle

ITEM	DESCRIPTION	UOM	CASE
CCS-8F	8" Fine	Each	12
CCS-10F	10" Fine	Each	12
CCS-12F	12" Fine	Each </td <td>12</td>	12
CCS-8C	8" Coarse	Each	12
CCS-10C	10" Coarse	Each	12
CCS-12C	12" Coarse	Each	12

### STAINLESS STEEL STRAINERS



### CHINOIS PESTLE

- ◆ Solid wood construction
- ◆ Press, crush and push mixtures through a bouillon strainer
- ◆ Fits standard size strainers

ITEM	DESCRIPTION	UOM	CASE
WPST-13	13-7/8"L x 3-1/8"Dia	Each	6/24

### WOODEN PESTLE



### SCOOP COLANDER

Scoop and strain pasta or vegetables with the scoop colander. With its long handle, the scoop colander is ideal for easily lifting food out of pots, woks or friers.

- ◆ 18/8 stainless steel

ITEM	DESCRIPTION	UOM	CASE
CODS-7	7"L x 4"W, 11"L Hdl	Each	4/16

### SCOOP COLANDER



## SKIMMERS



### HEAVY-DUTY SKIMMER

◆ One-piece stainless steel construction

ITEM	DESCRIPTION	HANDLE	UOM	CASE
SCS-6H	6-1/4"Dia	16"	Each	12/72

### SKIMMERS

◆ Stainless steel

ITEM	DESCRIPTION	HANDLE	UOM	CASE
SCS-5	4-1/2"Dia	13"	Each	12/120
SCS-6	5-3/4"Dia	13-1/2"	Each	12/120

### EXTRA STRENGTH SHORT HANDLE SKIMMER

◆ Stainless steel

ITEM	DESCRIPTION	UOM	CASE
SC-12	12"Dia	Each	12/24

## WIRE SKIMMERS

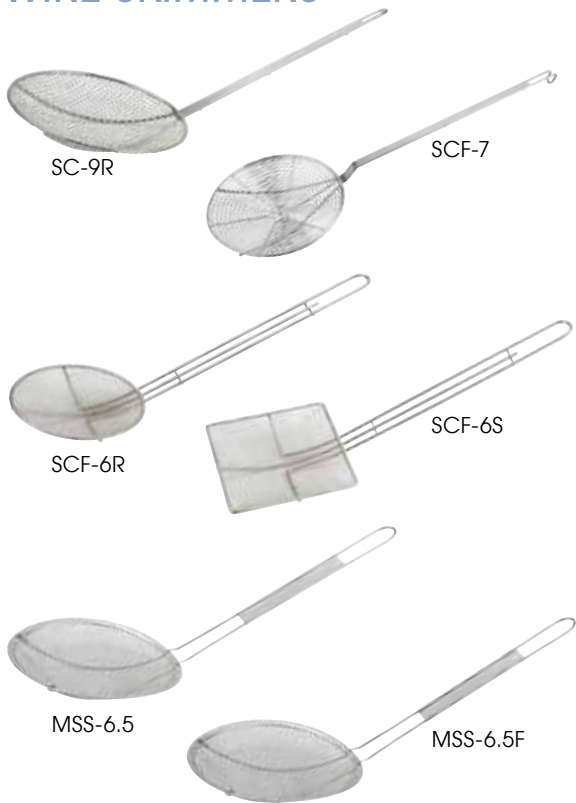

### WIRE SKIMMERS

◆ Nickel plated

ITEM	DESCRIPTION	HANDLE	UOM	CASE
SC-5R	5"Dia	13"	Each	12/36
SC-6R	6"Dia	13"	Each	12/36
SC-7R	7"Dia	13"	Each	12/36
SC-8R	8"Dia	13"	Each	12/24
SC-9R	9"Dia	13"	Each	12/24
SC-12R	12"Dia	13"	Each	12/24

### SPIRAL SKIMMERS

◆ Nickel plated

ITEM	DESCRIPTION	HANDLE	UOM	CASE
SCF-7	7"Dia	14"	Each	12/48
SCF-9	9"Dia	14"	Each	12/48

### MESH SKIMMERS

◆ Nickel plated

ITEM	DESCRIPTION	HANDLE	UOM	CASE
SCF-6R	6-1/2"Dia	13"	Each	12/48
SCF-6S	6-3/4" x 6-3/4"	13"	Each	12/48

### SINGLE MESH SKIMMERS

◆ Stainless steel

ITEM	DESCRIPTION	HANDLE	UOM	CASE
MSS-6F	6"Dia, Fine	13"	Each	12/120
MSS-6.5F	6-1/2"Dia, Fine	13"	Each	12/120
MSS-6	6"Dia, Coarse	13"	Each	12/120
MSS-6.5	6-1/2"Dia, Coarse	13"	Each	12/120

## STRAINERS



### STAINLESS STEEL SPAGHETTI STRAINER

◆ 18/8 stainless steel

◆ Tri-riveted handle with helper hook that rests over rim of pot



ITEM	DESCRIPTION	HANDLE	UOM	CASE
SSS-3	8-1/2"Dia	8"	Each	6/24

### ALUMINUM SPAGHETTI STRAINERS

ITEM	DESCRIPTION	HANDLE	UOM	CASE
ASS-09	9"Dia	7-1/2"	Each	12
ASS-10	10"Dia	6-3/4"	Each	12



**REINFORCED DOUBLE MESH**

◆ Nickel plated

ITEM	DESCRIPTION	DIA	UOM	CASE
MST-10RB	Flat Handle	10-1/2"	Each	12
MST-1010D	Round Handle	10-1/2"	Each	12
MST-12D	Round Handle	12"	Each	6
MST-14D	Round Handle	14"	Each	6

**FINE MESH STRAINERS**

◆ Stainless steel

ITEM	DESCRIPTION	DIA	UOM	CASE
MS3A-8D	Double Mesh	8"	Each	12/48
MS3A-8S	Single Mesh	8"	Each	12/48
MS2K-10D	Double Mesh	10-1/2"	Each	12/48
MS2K-10S	Single Mesh	10-1/2"	Each	12/48

**TINNED DOUBLE MESH**

ITEM	DESCRIPTION	DIA	UOM	CASE
MSTF-6D	Fine	6-1/4"	Each	12/96
MSTF-8D	Fine	8"	Each	12/48
MSTF-10D	Fine	10-1/4"	Each	12/24
MST-6D	Medium	6-1/4"	Each	12/96
MST-8D	Medium	8"	Each	12/48
MST-10D	Medium	10-1/2"	Each	12/24

**TINNED SINGLE MESH**

ITEM	DESCRIPTION	DIA	UOM	CASE
MSTF-6S	Fine	6-1/4"	Each	12/96
MSTF-8S	Fine	8"	Each	12/48
MSTF-10S	Fine	10-1/4"	Each	12/24
MST-6S	Medium	6-1/4"	Each	12/96
MST-8S	Medium	8"	Each	12/48
MST-10S	Medium	10-1/4"	Each	12/24

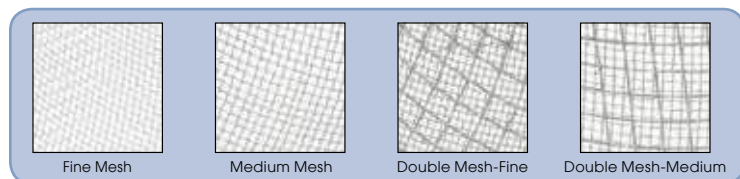

**SINGLE MESH STRAINER**

ITEM	DESCRIPTION	DIA	UOM	CASE
MSH-5	Deep Bowl	5-1/2"	Each	12/48

**CULINARY BASKETS**

◆ Nickel plated steel

ITEM	DESCRIPTION	DIA	UOM	CASE
MSB-08	Coarse Mesh	8"	Each	12/36
MSB-08M	Medium Mesh	8"	Each	12/36
MSB-08F	Fine Mesh	8"	Each	12/36
MSB-10	Coarse Mesh	10"	Each	12/36
MSB-10M	Medium Mesh	10"	Each	12/36
MSB-10F	Fine Mesh	10"	Each	12/36
MSB-12	Coarse Mesh	12"	Each	30
MSB-12M	Medium Mesh	12"	Each	30
MSB-12F	Fine Mesh	12"	Each	30

**STAINLESS STEEL MESH STRAINERS**



**CULINARY BASKETS**



DISPENSERS & FUNNELS



OC-24



PBST-1.5



SF-6



SF-6S



SAF-05

SAF-1

SAF-2

SAF-4



SAF-1ST



SAF-1ST inside detail



SAF-8



PF-32



OIL CAN WITH BRASS COVER

ITEM	DESCRIPTION	UOM	CASE
OC-24	24 Oz	Each	12



PLASTIC BASTER

◆ 1-1/2 oz capacity with rubber bulb

ITEM	DESCRIPTION	UOM	CASE
PBST-1.5	7-1/2" Tube, 11" O.L.	Each	12/72

WIDE-MOUTH FUNNELS & REMOVABLE STRAINERS

◆ Stainless steel mirror finish for SF-5 and SF-6

ITEM	DESCRIPTION	UOM	CASE
SF-5	5" Funnel	Each	12/72
SF-6	5-3/4" Funnel	Each	12/72
SF-6S	Strainer for SF-6	Each	120/480

SPUN ALUMINUM FUNNELS

◆ Made of one-piece spun aluminum

ITEM	DESCRIPTION	UOM	CASE
SAF-05	1/2 Pt, 3-7/8"Dia x 3-5/8"H	Each	12/192
SAF-1	1 Pt, 5-1/4"Dia x 5-1/2"H	Each	12/192
SAF-1ST	1 Pt w/Strainer, 5-1/4"Dia x 5-1/4"H	Each	6/150
SAF-2	1 Qt, 7"Dia x 6-5/8"H	Each	6/54
SAF-4	2 Qt, 9-1/8"Dia x 7-3/4"H	Each	6/72
SAF-8	4 Qt, 8-3/4"Dia x 8"H	Each	6/54

PLASTIC FUNNELS

ITEM	DESCRIPTION	SIZE	UOM	CASE
PF-8	8 Oz	4"Dia	Each	6/324
PF-16	16 Oz	5-1/4"Dia	Each	6/324
PF-32	32 Oz	6-1/4"Dia	Each	6/216

**BUTTER ROLLER**

- ◆ Standard 1/6 size steam table pan, fits into 7"L x 6-3/8"W size opening
- ◆ Reduces butter and dressing waste
- ◆ Roller is removable for easy cleaning
- ◆ Spreads butter quickly and evenly
- ◆ Sturdy stainless steel construction
- ◆ Designed for countertop access
- ◆ Provides safe and sanitary food preparation

ITEM	DESCRIPTION	UOM	CASE
SPBR-604	7"L x 6-3/8"W	Each	6

**DISPENSERS**



SPBR-604

**WIDE-MOUTH SQUEEZE BOTTLES**

- ◆ Open tip, no cutting required, easy to refill
- ◆ Each pack contains six (6) pieces
- ◆ BPA-free

ITEM	DESCRIPTION	UOM	CASE
PSW-12	12 Oz, Clear	Pack	12
PSW-12R	12 Oz, Red	Pack	12
PSW-12Y	12 Oz, Yellow	Pack	12
PSW-16	16 Oz, Clear	Pack	8
PSW-16R	16 Oz, Red	Pack	8
PSW-16Y	16 Oz, Yellow	Pack	8
PSW-24	24 Oz, Clear	Pack	8
PSW-24R	24 Oz, Red	Pack	8
PSW-24Y	24 Oz, Yellow	Pack	8
PSW-32	32 Oz, Clear	Pack	6
PSW-32R	32 Oz, Red	Pack	6
PSW-32Y	32 Oz, Yellow	Pack	6



Wide-mouth squeeze bottle



6 per pack



PSW-24

PSW-SERIES



**REGULAR SQUEEZE BOTTLES**

- ◆ Open tip, no need for cutting
- ◆ Each pack contains six (6) pieces

ITEM	DESCRIPTION	UOM	CASE
PSB-08C	8 Oz, Clear	Pack	12
PSB-08R	8 Oz, Red	Pack	12
PSB-08Y	8 Oz, Yellow	Pack	12
PSB-12C	12 Oz, Clear	Pack	12
PSB-12R	12 Oz, Red	Pack	12
PSB-12Y	12 Oz, Yellow	Pack	12
PSB-24C	24 Oz, Clear	Pack	6
PSB-24R	24 Oz, Red	Pack	6
PSB-24Y	24 Oz, Yellow	Pack	6



PSB-SERIES



**SYRUP DISPENSERS**

- ◆ Stainless steel dispenser slide prevents dripping
- ◆ Ideal for batter, dressing, juice
- ◆ BPA-free

ITEM	DESCRIPTION	UOM	CASE
PSUD-32	32 Oz	Each	12
PSUD-48	48 Oz	Each	12
PSUD-WLid	Lid, White	Each	24/144
PSUD-RLid	Lid, Red	Each	24/144
PSUD-TLid	Lid, Tan	Each	24/144



PSUD-RLID



PSUD-TLID



PSUD-48



PSUD-32



## SCOOPS



IS-4



SSC-3



AS-85



ASFB-SERIES



PS-SERIES



PS-64

### STAINLESS STEEL SCOOPS

ITEM	DESCRIPTION	UOM	CASE
IS-4	4 Oz Ice Scoop	Each	12/144

### STAINLESS STEEL SCOOPS

ITEM	DESCRIPTION	UOM	CASE
SSC-2	2 Qt Utility Scoop	Each	6/24
SSC-3	3 Qt Utility Scoop	Each	6/18

### ALUMINUM SCOOPS

◆ Hand wash only

ITEM	DESCRIPTION	UOM	CASE
AS-5	5 Oz	Each	12/60
AS-12	12 Oz	Each	12/60
AS-24	24 Oz	Each	12/60
AS-38	38 Oz	Each	12/48
AS-58	58 Oz	Each	12/36
AS-85	85 Oz	Each	12/24

### ALUMINUM FLAT BOTTOM SCOOPS

◆ Hand wash only

ITEM	DESCRIPTION	UOM	CASE
ASFB-4	4 Oz	Each	12/72
ASFB-7	7 Oz	Each	12/72
ASFB-16	16 Oz	Each	12/72
ASFB-24	24 Oz	Each	12/48

### POLYCARBONATE SCOOPS

◆ NSF listed

ITEM	DESCRIPTION	UOM	CASE
PS-5	5 Oz	Each	24/144
PS-10	10 Oz	Each	24/144
PS-20	20 Oz	Each	24/144
PS-32	32 Oz	Each	12/72
PS-50	50 Oz	Each	12/72

### POLYPROPYLENE SCOOP

ITEM	DESCRIPTION	UOM	CASE
PS-64	64 Oz, White	Each	12/48

## SCOOP HOLDERS



WHW-4



WHW-7



Scoops sold separately

### SCOOP HOLDERS

- ◆ Mounted to the wall for ease of reach and sanitation
- ◆ Keeps scoops off food prep surfaces
- ◆ Plastic coated wire

ITEM	DESCRIPTION	SIZE (L X W)	UOM	CASE
WHW-4	Holds AS-12, AS-24, PS-10 & PS-20	4-1/4" x 5-3/8"	Each	12/48
WHW-7	Holds AS-38, AS-58, PS-32 & PS-50	7" x 8"	Each	12/48



## ERGONOMIC KITCHEN TOOLS

- ◆ Made of stainless steel with a comfortable non-slip soft-grip handle
- ◆ Dishwasher safe
- ◆ NSF listed

ITEM	DESCRIPTION	UOM	CASE
VP-300	Straight Edge "Y" Peeler	Each	12/72
VP-301	Serrated Edge "Y" Peeler	Each	12/72
VP-302	Julienne Peeler	Each	12/72
VP-303	Straight Peeler	Each	12/72
VP-304	Serrated Edge Straight Peeler	Each	12/72
VP-305	Apple Corer	Each	12/72
VP-306	Zester/Lemon Peeler	Each	12/72
VP-307	Melon Baller	Each	12/72
VP-308	Tomato Stem Corer	Each	12/72
VP-309	Cheese Plane	Each	12/72
VP-310	Butter Curler	Each	12/72
VP-314	2-7/8" Oyster/Clam Knife	Each	12/72
VP-315	Small Pizza Cutter 2-1/2" Wheel Blade	Each	12/72
VP-316	Large Pizza Cutter 4" Wheel Blade	Each	12/72
VP-311	Grater w/1.5mm Dia Holes	Each	12/72
VP-312	Grater w/3mm Dia Holes	Each	12/72
VP-313	Grater w/6mm Dia Holes	Each	12/72



**EXTRA STRENGTH  
WIRE FRAME  
RESISTS BENDING**

## ERGONOMIC KITCHEN TOOLS

VP-SERIES **NSF**



VP-300



VP-301



VP-302



VP-303



VP-304



VP-305



VP-306



VP-307



VP-308



VP-309



VP-310



VP-314



VP-315



VP-316



VP-311



VP-312



VP-313



## ROTARY CHEESE GRATERS



### STAINLESS STEEL CHEESE GRATER

- ◆ 18/8 stainless steel rotary grater with one drum for grating fine cheeses

ITEM	DESCRIPTION	UOM	CASE
GRTS-1	8-1/4"L x 4-3/4"W x 3-3/8"H	Each	12/36



### PLASTIC CHEESE GRATER

- ◆ Ideal for grating hard cheese or chocolate
- ◆ Includes two (2) interchangeable drums for fine and coarse grating
- ◆ Dishwasher safe

ITEM	DESCRIPTION	UOM	CASE
PRTS-2	7"L x 3-1/2"W x 4-3/8"H	Each	6/24

## GRATERS WITH COVER

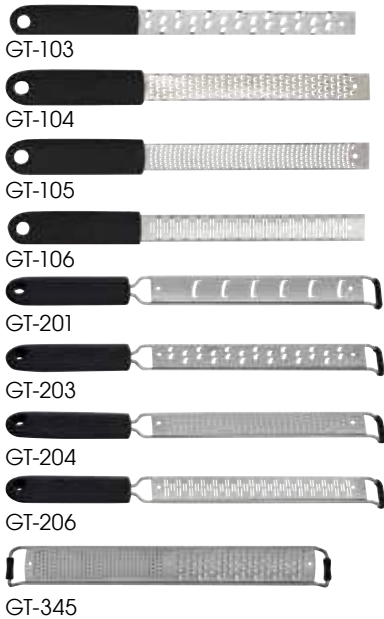

### GRATERS WITH COVER

- ◆ Etched 18/8 stainless steel blade, black soft-grip handle
- ◆ Anti-corrosive and durable
- ◆ Anti-slip feet (only available on GT-201/203/204/206)
- ◆ Two blade types in one product (GT-345 only)
- ◆ Dishwasher safe

ITEM	DESCRIPTION	UOM	CASE
GT-103	Medium Coarse Blade	Each	12/72
GT-104	Zester Blade	Each	12/72
GT-105	Fine Blade	Each	12/72
GT-106	Ribbon Blade	Each	12/72
GT-201	Slicer Blade & Anti-Slip Feet	Each	12/72
GT-203	Medium Coarse Blade & Anti-Slip Feet	Each	12/72
GT-204	Zester Blade & Anti-Slip Feet	Each	12/72
GT-206	Ribbon Blade & Anti-Slip Feet	Each	12/72
GT-345	Half Zester / Half Fine Blade & Anti-Slip Feet	Each	12/72

	GT-100 series, with soft grip handle, one side blade (one type per item)	GT-200 series, with additional anti-slip feet feature and all features of GT-100 series	GT-301 with anti-slip feet and 2 types of blade on one item	GT-401 with 5 sides of different blades and soft grip handle
<b>SLICER</b>			GT-201	✓
<b>MEDIUM COARSE</b>		GT-103	GT-203	✓
<b>ZESTER</b>		GT-104	GT-204	✓
<b>FINE</b>		GT-105		✓
<b>RIBBON</b>		GT-106	GT-206	✓

## BOX GRATERS



### ERGONOMIC BOX GRATER

- ◆ Etched 18/8 stainless steel blade, black soft-grip handles

ITEM	DESCRIPTION	UOM	CASE
GT-401	5-Sided Grater: Slicer, Medium Coarse, Zester, Fine, Ribbon	Each	12/48

### STAINLESS STEEL BOX GRATERS

ITEM	DESCRIPTION	SIZE	UOM	CASE
SQG-1	Tapered Grater	4" x 3" x 9"	Each	12/72
SQG-4	Box Grater	9" x 4"	Each	12/24

**PINEAPPLE CORER**

- ◆ Heavy-duty stainless steel cutting shaft
- ◆ Cores and rings pineapple with a simple twist, extracting fruit without eyes or peels attached
- ◆ Includes cap to protect serrated teeth when not in use

ITEM	DESCRIPTION	UOM	CASE
SPC-3	Pineapple Corer	Each	6/24

**FRUIT PREP TOOLS**



SPC-3

**CHERRY CORER**

- ◆ Quickly and easily remove cherry or olive pits
- ◆ Stainless steel
- ◆ Dishwasher safe

ITEM	DESCRIPTION	UOM	CASE
SCC-5	5-1/4" O.L.	Each	12/144



SCC-5

**APPLE DIVIDER/CORER**

- ◆ Aluminum

ITEM	DESCRIPTION	UOM	CASE
AAD-12	4-3/8"Dia	Each	12/48



AAD-12

**TOMATO STEM CORER**

ITEM	DESCRIPTION	UOM	CASE
TSC-2	Stainless Steel	Doz	24/144



TSC-2

**MELON BALLER**

ITEM	DESCRIPTION	UOM	CASE
MB-1	2-Sided, Wooden Hdl	Each	24/240



MB-1

**GRAPEFRUIT SPOON**

*Complete any table setting with this grapefruit spoon. The serrated edge cuts easily into any citrus fruit, which also makes it ideal for food prep.*

- ◆ Stainless steel

ITEM	DESCRIPTION	UOM	CASE
SRS-6	6-1/4" O.L.	Doz	25



SRS-6

**MANUAL JUICE SQUEEZER**

- ◆ Stainless steel

ITEM	DESCRIPTION	UOM	CASE
JC-4	5"Dia	Each	24



JC-4

**HANDHELD CITRUS SQUEEZERS**

*Extract all the juice without the rind, pulp or seeds.*

- ◆ Made from aluminum with baked-on enamel coating
- ◆ Place citrus half with cut side down in juicer and extract
- ◆ Dishwasher safe, long lasting, won't absorb odors, as well as resistant to moisture, heat and stains

ITEM	DESCRIPTION	UOM	CASE
LS-8G	2-1/2"Dia	Each	6/48
LS-9O	3-1/2"Dia	Each	9/36
LS-9Y	3"Dia	Each	6/48

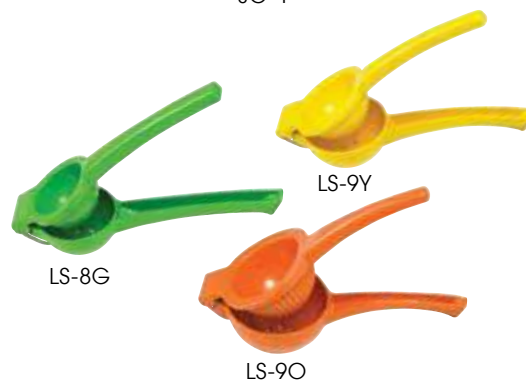

LS-8G

LS-9Y

LS-9O

SPECIALTY UTENSILS

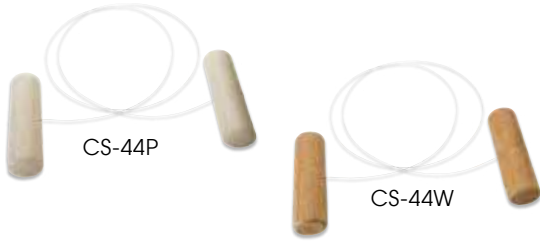

WIRE CHEESE SLICERS

- ◆ Provides a smoother cut than cheese knives
- ◆ 44" long 18/8 stainless steel wire
- ◆ Customized control over slicing thickness and angle
- ◆ Easy cleanup

ITEM	DESCRIPTION	UOM	CASE
CS-44P	Polyethylene Hdl	Each	24/144
CS-44W	Wooden Hdl	Each	24/144



PLK-11G



PLASTIC LETTUCE KNIFE

- ◆ Prevents oxidation so lettuce will not turn brown
- ◆ Serrated edges are also ideal for cutting fruits, and slicing bread and cake
- ◆ Safe to use on non-stick cookware
- ◆ Dishwasher safe

ITEM	DESCRIPTION	UOM	CASE
PLK-11G	11-1/2"L	Each	24/144



POA-8



PAIL OPENER

- ◆ Aluminum

ITEM	DESCRIPTION	UOM	CASE
POA-8	8-7/16"L x 1-7/16"W x 2-3/4"H	Each	6/72

SHEARS



KS-06



Detachable



KS-01



KITCHEN SHEARS

ITEM	DESCRIPTION	UOM	CASE
KS-01	All purpose	Each	12/120
KS-06*	All purpose, Detachable	Each	12/72

\*Replaces KS-04



KS-02



POULTRY SHEARS

ITEM	DESCRIPTION	UOM	CASE
KS-02	Stainless Steel, Soft PP Hdl	Each	12/72
KS-03	Stainless Steel	Each	10/50



KS-03



Easily cut, chop, and mince herbs



KS-05



HERB SHEARS

Chopping fresh herbs is now easy with these shears featuring five (5) durable stainless steel blades.

- ◆ Works well on basil, thyme, mint and more
- ◆ Ideal for cutting, chopping and mincing herbs
- ◆ Comfortable PP and TPR handles for easy grip

ITEM	DESCRIPTION	UOM	CASE
KS-05	5-Layer Blade	Each	12/72



**GARLIC PRESS & SLICER**

- ◆ All-in-one garlic press and slicer
- ◆ Made of rust-resistant aluminum alloy with a non-stick coating
- ◆ Simplify cleaning with tool attached to inside of handle
- ◆ Easy to store and convenient to use
- ◆ Solid, sturdy, comfortable-to-squeeze handles

ITEM	DESCRIPTION	UOM	CASE
GP-2	Aluminum Alloy, Non-Stick	Each	72

**GARLIC PRESS**

ITEM	DESCRIPTION	UOM	CASE
GP-1	Aluminum Alloy	Each	12/96

**NUT CRACKER**

- ◆ Stainless steel

ITEM	DESCRIPTION	UOM	CASE
LC-04	4-3/4"	Each	24/144

**VEGETABLE PEELERS**

ITEM	DESCRIPTION	UOM	CASE
VP-1	Nickel Plated Handle	Doz	2/24
VP-2	Plastic Handle	Doz	2/24

**SERRATOR**

- ◆ Stainless steel

ITEM	DESCRIPTION	UOM	CASE
SRT-7	7" w/Wooden Hdl	Each	12/72

**EGG SEPARATOR**

- ◆ 8-1/2" easy-grip hollow handle
- ◆ Stainless steel handle and blade
- ◆ Easy to separate an egg white from its yolk
- ◆ Great for preparing crême brûlée, pudding, tiramisu and soufflé
- ◆ Dishwasher safe

ITEM	DESCRIPTION	UOM	CASE
SES-3	2-7/8"Dia	Each	24/96

**EGG SLICERS**

- ◆ Square egg slicer's stainless steel wires are clamped into the wire casing
- ◆ No risk of wires slipping out of the pegs
- ◆ Aluminum

ITEM	DESCRIPTION	UOM	CASE
AES-1	Round	Each	12/144
AES-4	Square	Each	96

**SPECIALTY UTENSILS**



GP-2



GP-1



LC-04



VP-1



VP-2



SRT-7



SES-3



AES-1



AES-4

## MEAT PREP TOOLS



MT-4



AMT-2



AMT-3



AMT-4



SWA-5

SWA-2



HP-4



PSM-SERIES

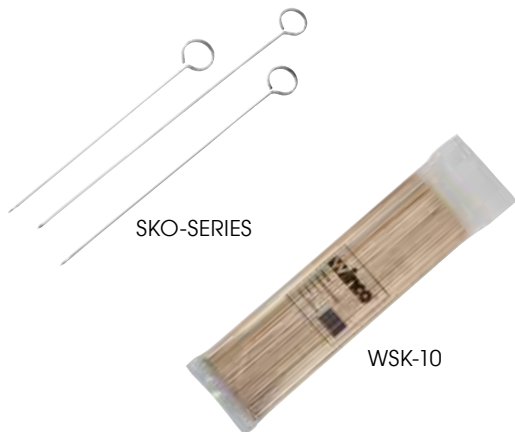

SKO-SERIES

WSK-10

## ALUMINUM MEAT TENDERIZERS

ITEM	DESCRIPTION	HEAD SIZE	O.L.	UOM	CASE
MT-4	2-Sided, Wooden Hdl,	3" x 2-1/2"	13"	Each	12/24
AMT-2	2-Sided	3" x 3"	10-1/2"	Each	36
AMT-3	3-Sided	3" x 2-3/8"	11"	Each	20
AMT-4	2-Sided, Heavy Alu	4-1/4" x 2-3/4"	12-3/4"	Each	12

## STEAK WEIGHTS

- ◆ Press meats for even cooking

ITEM	DESCRIPTION	SIZE	UOM	CASE
SWA-1	1 Lb Cast Alu	4-1/4" x 8-1/4"	Each	12
SWA-5	1 Lb Cast Alu	5-1/4" x 9"	Each	12
SWA-2	2 Lbs Cast Iron	4-1/4" x 8-1/4"	Each	6
SWA-9	2.5 Lbs Cast Iron	5-1/4" x 9"	Each	6

## HAMBURGER PRESS

- ◆ Adjustable patty thickness

ITEM	DESCRIPTION	UOM	CASE
HP-4	4-1/2"Dia	Each	12/36

## STEAK MARKERS

- ◆ Each bag contains 1,000 pieces
- ◆ 2.0mm thickness
- ◆ Labeled for rare, medium rare, medium, medium well and well done

ITEM	DESCRIPTION	COLOR	UOM	CASE
PSM-R	Rare	Red	Bag	5
PSM-MR	Medium Rare	Pink	Bag	5
PSM-M	Medium	White	Bag	5
PSM-MW	Medium-Well	Yellow	Bag	5
PSM-W	Well Done	Tan	Bag	5

## OVAL STAINLESS STEEL SKEWERS

- ◆ Flat needle keeps food from turning while cooking/grilling

ITEM	DESCRIPTION	UOM	CASE
SKO-8	8"	Doz	5/100
SKO-10	10"	Doz	5/60
SKO-12	12"	Doz	5/60

## BAMBOO SKEWERS

- ◆ Each bag contains 100 pieces

ITEM	DESCRIPTION	UOM	CASE
WSK-06	6"	Bag	30/240
WSK-08	8"	Bag	30/240
WSK-10	10"	Bag	30/120
WSK-12	12"	Bag	30/120

### SHRIMP DEVEINER

- ◆ Devein and peel shrimp with one tool
- ◆ Aluminum

ITEM	DESCRIPTION	UOM	CASE
SDA-7	2-Pcs/Pk	Pack	12/144

### SCALE PEELER

- ◆ Stainless steel
- ◆ NSF listed

ITEM	DESCRIPTION	UOM	CASE
FSP-9	9-1/2"L	Each	60/240

### LOBSTER CRACKERS

ITEM	DESCRIPTION	SIZE	UOM	CASE
LC-01	Stainless Steel	6"	Each	12/72
LC-03	Chrome Plated, Large	6"	Each	12/144
LC-04	Nut / Lobster Cracker	4-3/4"	Each	24/144
LC-05	Zinc Alloy	6"	Each	12/72
LC-85	Zinc Alloy, Carded	6"	Each	12/72

### SEAFOOD PICKS

- ◆ 18/8 stainless steel with decorative lobster stamp
- ◆ Narrow two-fine fork designed to effortlessly reach more shellfish meat
- ◆ Each pack contains four (4) pieces

ITEM	DESCRIPTION	UOM	CASE
LC-08	8"L x 3/4"W	Pack	30/120

## SEAFOOD PREPARATION



SDA-7



FSP-9



LC-01



LC-03



LC-04

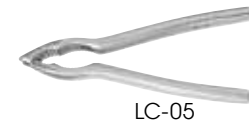

LC-05



LC-85



LC-08

### OYSTER/CLAM KNIVES

ITEM	DESCRIPTION	SIZE	UOM	CASE
VP-314	2-7/8" Blade, Soft Rubber Grip NSF	7-5/8" O.L.	Each	12/72
KCL-5P	3" Blade, Plastic Handle, NSF	6-3/4" O.L.	Each	12/72
KCL-1	2-3/4" Blade, Wooden Handle	5-7/8" O.L.	Each	12/72
KCL-2	2-7/8" Blade, Wooden Handle	6-5/8" O.L.	Each	12/72
KCL-3	3-1/2" Blade, Wooden Handle	7-1/2" O.L.	Each	12/72

### OYSTER/CLAM KNIVES



VP-314



KCL-5P



KCL-3



KCL-2



KCL-1

### STAINLESS STEEL PROTECTIVE MESH GLOVES

Made for meat processing, the rust-resistant 304L stainless steel rings that form these mesh gloves protect hands from cuts and punctures while deboning and butchering. Each glove is reversible and is fixed with a wrist strap that features a snap and cinch fastener to keep it secure.

- ◆ Lightweight and non-corrosive
- ◆ Wrist length

ITEM	DESCRIPTION	SIZE	UOM	CASE
PMG-1S	White Strap	Small	Each	10/50
PMG-1M	Red Strap	Medium	Each	10/50
PMG-1L	Blue Strap	Large	Each	10/50

### PROTECTIVE GLOVES



Closure Detail



Mesh Detail



PMG-1L

GRILL TOOLS



KFP-71



KFP-121



KFP-140



KFP-180



KPF-612



KPF-210



ACERO FORGED COOK'S FORKS

◆ Extra heavyweight with POM handle

ITEM	DESCRIPTION	LENGTH	UOM	CASE
KFP-71	11" O.L. Straight	4" Prongs	Each	6/36
KFP-121	12" O.L. Curved	8" Prongs	Each	6/36
KFP-140	14" O.L. Curved	9" Prongs	Each	6/36
KFP-180	18" O.L. Curved	9" Prongs	Each	6/36

POT FORKS

ITEM	DESCRIPTION	UOM	CASE
KPF-612	12-5/8" O.L.	Each	12/120
KPF-210	21-7/8" O.L.	Each	12/72



STN-3



PANCAKE TURNER

◆ Heat resistant up to 608°F (320°C)

◆ Nylon blade with 18/8 stainless steel handle

ITEM	DESCRIPTION	UOM	CASE
STN-3	15-7/16" O.L.	Each	24/48

SERVING TURNERS

◆ Stainless steel

ITEM	DESCRIPTION	UOM	CASE
STN-6	14" O.L., Solid	Each	12/120
STN-8	14" O.L., Slotted	Each	12/120



STN-6

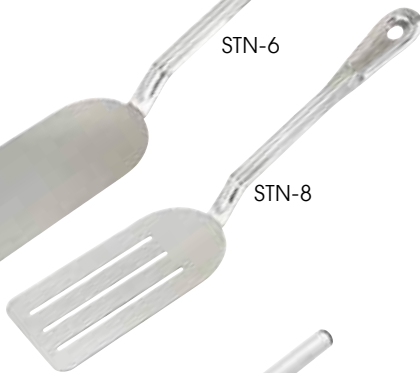

STN-8



APP-20

ALUMINUM PIZZA/BURGER PEEL

◆ 14 gauge, 1.6mm thick

◆ 11" handle, 20" overall length

ITEM	DESCRIPTION	UOM	CASE
APP-20	9"L x 6-3/4"W Blade	Each	12/48

### EGG RINGS

- ◆ Stainless steel

ITEM	DESCRIPTION	UOM	CASE
EGR-3	3" Dia x 1"L	Each	12/144
EGR-4	4" Dia x 1"L	Each	12/144
EGR-5	5" Dia x 1"L	Each	12/144
EGR-6	6" Dia x 1"L	Each	12/96
EGRS-44	4" Square x 1"	Each	12/144

### GRILL TOOLS



EGR-6



EGRS-44

### GRILL BASTING COVERS

- ◆ Contain mess and splatter from frying food on the grill
- ◆ Cover entrée to keep it warm until ready to serve
- ◆ Aluminum with Bakelite knob handle

ITEM	DESCRIPTION	UOM	CASE
ADBC-7	7"Dia	Each	6/12
ADBC-8	8"Dia	Each	6/12
ADBC-9	9"Dia	Each	6/12
ADBC-10	10"Dia	Each	6/12



ADBC-7

### DOMED GRILL BASTING COVER

- ◆ Used to cover hamburgers and hold in steam for thorough, even cooking
- ◆ Aluminum

ITEM	DESCRIPTION	UOM	CASE
AHC-6	6"Dia	Each	12/48



AHC-6

### FRENCH FRY BAGGERS

ITEM	DESCRIPTION	UOM	CASE
FFB-1R	Right Handle	Each	12/36
FFB-2	Dual Handles	Each	12/36

### FRYER ACCESSORIES



FFB-1R



FFB-2

### FRYER FILTER STAND & FILTER

- ◆ Cloth filters are heat resistant up to 392°F (200°C)

ITEM	DESCRIPTION	UOM	CASE
FF-10	10" Fryer Filter Stand	Each	20
FF-RC	Rayon Cloth Filter Cones (10-Pcs/Box)	Box	60



FF-10 & FF-RC

### FRYER SCREEN

- ◆ For use with: Imperial: IFS-40; DCS: FRFG-40; American Range: AF-45; PITCO: 35C and 45C
- ◆ Chrome-plated

ITEM	DESCRIPTION	UOM	CASE
FS-1313	13" x 13"	Each	12/48

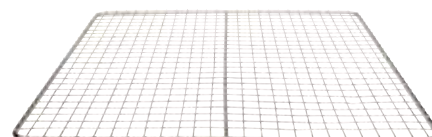

FS-1313

The **SIGNATURE LOOK**  
GREAT QUALITY. GREAT VALUE.



**SIGNATURE CHEF APPAREL**

*Keep your staff looking sharp in the kitchen with the Signature Chef clothing collection.*

- ◆ Short-sleeved chef shirts feature a chest pocket and snap-button fasteners
- ◆ Lightweight, 65/35 poly-cotton blend
- ◆ Available in black and white



UNF-1KL



UNF-1WL

**BLACK CHEF SHIRTS**

ITEM	COLOR	SIZE	UOM	CASE
UNF-1KS	Black	S	Each	24
UNF-1KM	Black	M	Each	24
UNF-1KL	Black	L	Each	24
UNF-1KXL	Black	XL	Each	24
UNF-1KXXL	Black	2X	Each	24

**WHITE CHEF SHIRTS**

ITEM	COLOR	SIZE	UOM	CASE
UNF-1WS	White	S	Each	24
UNF-1WM	White	M	Each	24
UNF-1WL	White	L	Each	24
UNF-1WXL	White	XL	Each	24
UNF-1WXXL	White	2X	Each	24

SIGNATURE CHEF APPAREL



**CHEF JACKETS**

- ◆ Universal fit
- ◆ Double breasted with pen/thermometer pocket
- ◆ 65/35 poly-cotton blend
- ◆ Available in black and white

ITEM	COLOR	SIZE	UOM	CASE
UNF-5KS	Black	S	Each	24
UNF-5KM	Black	M	Each	24
UNF-5KL	Black	L	Each	24
UNF-5KXL	Black	XL	Each	24
UNF-5KXXL	Black	2X	Each	24

ITEM	COLOR	SIZE	UOM	CASE
UNF-5WS	White	S	Each	24
UNF-5WM	White	M	Each	24
UNF-5WL	White	L	Each	24
UNF-5WXL	White	XL	Each	24
UNF-5WXXL	White	2X	Each	24



UNF-5KL Chef Jacket  
UNF-4KL Houndstooth Pants



UNF-5WL Chef Jacket  
UNF-2KL Black Pants

**BLACK CHEF PANTS**

- ◆ Relaxed fit
- ◆ Elastic waistband with drawstring
- ◆ 65/35 poly-cotton blend

ITEM	COLOR	SIZE	UOM	CASE
UNF-2KS	Black	S	Each	24
UNF-2KM	Black	M	Each	24
UNF-2KL	Black	L	Each	24
UNF-2KXL	Black	XL	Each	24
UNF-2KXXL	Black	2X	Each	24

**HOUNDSTOOTH CHEF PANTS**

- ◆ Relaxed fit
- ◆ Elastic waistband with drawstring
- ◆ 65/35 poly-cotton blend

ITEM	COLOR	SIZE	UOM	CASE
UNF-4KS	Houndstooth	S	Each	24
UNF-4KM	Houndstooth	M	Each	24
UNF-4KL	Houndstooth	L	Each	24
UNF-4KXL	Houndstooth	XL	Each	24
UNF-4KXXL	Houndstooth	2X	Each	24

SIZING GUIDE

**SHIRT SIZING CHART**

MEASUREMENT (INCHES)	S	M	L	XL	2XL
Chest	44	48	51	54	56
Center Back	27	28	30	32	33

**JACKET SIZING CHART**

MEASUREMENT (INCHES)	S	M	L	XL	2XL
Chest	43-45	46-48	50-52	52-55	56-60
Center Back	30	31	32	32.5	33

**PANTS SIZING CHART**

MEASUREMENT (INCHES)	S	M	L	XL	2XL
Waist	36	40	43	46	49
Hip	40	44	47	50	53
Inseam	29	30	31	32	33

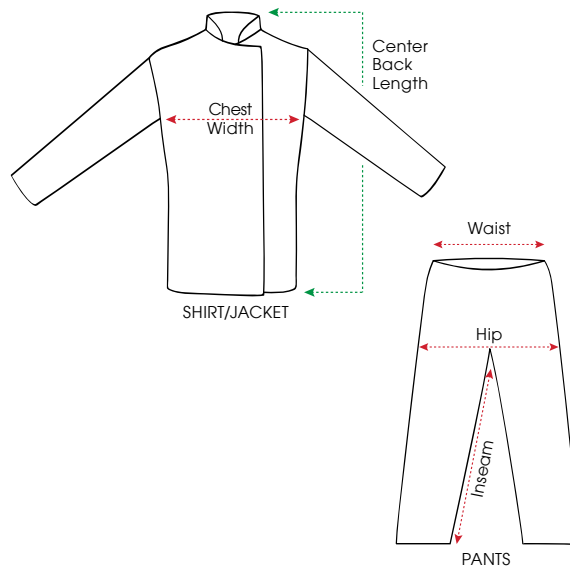

## CHEF HATS



Adjustable  
velcro closure



CH-13LG



CH-13BG



CH-13BK



CH-13BL



CH-13GN



CH-13RD



CH-13WH



CH-13YL



DCH-12



DCH-9



DCH-3



## PROFESSIONAL CHEF HATS

- ◆ Cotton-poly blend, machine wash and dry
- ◆ Wrinkle resistant
- ◆ Adjustable velcro closure, one size fits most
- ◆ 13" high, band dimension adjusts from 21" to 24"
- ◆ Assorted colors available

ITEM	DESCRIPTION	UOM	CASE
CH-13BG	Burgundy	Each	24/96
CH-13BK	Black	Each	24/96
CH-13BL	Blue	Each	24/96
CH-13GN	Green	Each	24/96
CH-13LG	Light Green	Each	24/96
CH-13RD	Red	Each	24/96
CH-13WH	White	Each	24/96
CH-13YL	Yellow	Each	24/96

## DISPOSABLE CHEF HATS

ITEM	DESCRIPTION	SIZE	UOM	CASE
DCH-3	3" H	100 pcs/Box	Box	10
DCH-9	9" H	10 pcs/Bag	Bag	20
DCH-12	12" H	10 pcs/Bag	Bag	20

## BIB APRONS



BA-SERIES W/ PEN & PAD POCKETS



BA-SERIES  
WITHOUT POCKETS



BA-LA



BA-HN



## KITCHEN APRONS

- ◆ Pen and pad pockets on select items
- ◆ Cotton-poly blend, machine wash and dry
- ◆ Wrinkle resistant
- ◆ Assorted colors available
- ◆ 31"L x 26"W

ITEM	DESCRIPTION	UOM	CASE
BA-3226BK	Black w/o Pockets	Each	12/60
BA-3226WH	White w/o Pockets	Each	12/60
BA-PBG	Burgundy w/Pockets	Each	12/60
BA-PBK	Black w/Pockets	Each	12/60
BA-PBL	Blue w/Pockets	Each	12/60
BA-PGN	Green w/Pockets	Each	12/60
BA-PLG	Light Green w/Pockets	Each	12/60
BA-PRD	Red w/Pockets	Each	12/60
BA-PWH	White w/Pockets	Each	12/60
BA-PYL	Yellow w/Pockets	Each	12/60



## PREPPING APRONS

ITEM	DESCRIPTION	SIZE	UOM	CASE
BA-HN	Heavy Naugahyde w/Pocket	26-1/2"W x 41-1/4"L	Each	12/24
BA-LA	Latex, Black	37"W x 44-1/2"L	Each	12



**WHITE COTTON SERVICE GLOVES**

ITEM	DESCRIPTION	UOM	CASE
GLC-M	Medium (6 pairs)	Doz	100
GLC-L	Large (6 pairs)	Doz	100

**BISTRO-LENGTH APRON**

◆ Cotton-poly blend, machine wash and dry, wrinkle resistant

ITEM	DESCRIPTION	UOM	CASE
WA-3129K	31"L x 29-1/2"W	Each	12/60

**3-POCKET WAIST APRONS**

◆ Cotton-poly blend, machine wash and dry, wrinkle resistant

ITEM	DESCRIPTION	COLOR	UOM	CASE
WA-1221	12-1/2" x 21-3/4"	Black	Each	12/60
WA-1221G	12-1/2" x 21-3/4"	Green	Each	12/60
WA-1221R	12-1/2" x 21-3/4"	Burgundy	Each	12/60
WA-1221W	12-1/2" x 21-3/4"	White	Each	12/60

**WAIT SERVICE**



**TABLE COVERS**

◆ Easy clean vinyl with polyester-flannel backing  
 ◆ Checkered pattern available in multiple colors & sizes

ITEM	DESCRIPTION	SIZE	COLOR	UOM	CASE
TBCS-52B	Square	52" x 52"	Blue	Each	24
TBCS-52G	Square	52" x 52"	Green	Each	24
TBCS-52R	Square	52" x 52"	Red	Each	24
TBCS-52K	Square	52" x 52"	Black	Each	24
TBCO-70B	Rectangular	52" x 70"	Blue	Each	24
TBCO-70G	Rectangular	52" x 70"	Green	Each	24
TBCO-70R	Rectangular	52" x 70"	Red	Each	24
TBCO-70K	Rectangular	52" x 70"	Black	Each	24
TBCO-90B	Rectangular	52" x 90"	Blue	Each	24
TBCO-90G	Rectangular	52" x 90"	Green	Each	24
TBCO-90R	Rectangular	52" x 90"	Red	Each	24
TBCO-90K	Rectangular	52" x 90"	Black	Each	24

**TABLE COVERS**



**TABLE CLOTH CLIP**

◆ Perfect for outdoor events

ITEM	DESCRIPTION	UOM	CASE
TBC-1	Stainless steel	Doz	6/60

**GLASS POLISHING TOWEL**

◆ 100% Cotton, lint-free and non-abrasive to eliminate streaking, yet is gentle on glassware  
 ◆ Thousands of microscopic fibers pick up dirt and dust  
 ◆ Absorbs seven times its weight in liquids, also ideal for countertops and tabletops

ITEM	DESCRIPTION	UOM	CASE
BTGP-21	16" x 29", Red Pinstripes	Doz	10/20

**BAR & KITCHEN TOWELS**



**HERRINGBONE BAR TOWEL**

◆ 100% cotton; Super absorbent  
 ◆ Green stripe provides easy designation of towel for specific use to prevent cross-contact

ITEM	DESCRIPTION	UOM	CASE
BTH-2028G	20" x 28"	Doz	10/20

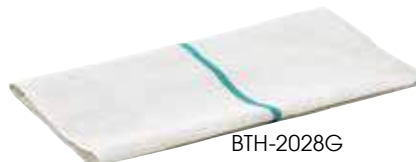

**MICROFIBER TOWELS**

◆ Light-weight, super absorbent and quick drying  
 ◆ Assorted pack contains white, green, yellow, brown, orange and red towels

ITEM	DESCRIPTION	UOM	CASE
BTM-16AC	16" x 16" Assorted, 6-Pcs/Pk	Pack	20
BTM-16W	16" x 16" White, 6-Pcs/Pk	Pack	20



**COTTON BAR TOWEL**

◆ 100% white cotton

ITEM	DESCRIPTION	UOM	CASE
BTW-30	16" x 19"	Doz	10/20



## POT HOLDERS



## POT HOLDERS

ITEM	DESCRIPTION	SIZE	UOM	CASE
PH-8B	One Side Fire Retardant, Other Side Terrycloth	8" x 8"	Doz	25
PH-8S	Cotton	8" x 8"	Doz	25
PH-9W	White Terrycloth w/Pocket	8-1/2" x 9-1/2"	Doz	15

## PAN GRABBER



## PAN GRABBER

◆ Heat-resistant up to 400°F (205°C)

ITEM	DESCRIPTION	SIZE	UOM	CASE
PH-811W	Terry Cloth	11" x 8"	Doz	15

## PAN HANDLE SLEEVES



## PAN HANDLE SLEEVES

◆ Heat-resistant up to 250°F (121°C)

ITEM	DESCRIPTION	SIZE	UOM	CASE
HDH-7S	Cotton Sleeve	3-1/2" x 6-1/2"	Doz	24
HDH-6C	Chili Peppers Cotton Sleeve	3-1/2" x 6-1/2"	Doz	24

## OVEN MITTS



## OVEN MITTS

◆ Heat-resistant up to 200°F (93°C)

◆ 100% cotton

ITEM	DESCRIPTION	UOM	CASE
OMS-13	13"	Each	12/72
OMS-15	15"	Each	12/72
OMS-17	17"	Each	12/72

## FLAME RETARDANT OVEN MITTS

◆ Flame-resistant up to 400°F (205°C)

◆ OMF-24 is extra-long for full arm protection

ITEM	DESCRIPTION	UOM	CASE
OMF-13	13"	Each	12/72
OMF-15	15"	Each	12/72
OMF-17	17"	Each	12/72
OMF-24	24"	Each	12/72

## TERRY-CLOTH OVEN MITTS

◆ Heat-resistant up to 600°F (315°C)

ITEM	DESCRIPTION	UOM	CASE
OMT-13	13"	Each	12/72
OMT-17	17"	Each	12/72

# BACK OF HOUSE

## *Clean & Organize*



## GLOVES



NLG-816



NLGH-18



NLG-1018



GLC-M



GLP-M



### HEAVY-DUTY NATURAL LATEX GLOVES

- ◆ Soft, comfortable and durable
- ◆ Made especially for dish washers, launderers, car washers and gardeners

ITEM	DESCRIPTION	UOM	CASE
NLGH-18	10-1/2" x 18-1/2"	Pair	12/24



### NATURAL LATEX GLOVES

ITEM	DESCRIPTION	UOM	CASE
NLG-816	Small, Yellow	Pair	12/60
NLG-916	Medium, Yellow	Pair	12/60
NLG-1018	Large, Black	Pair	12/60



### GLOVES

- ◆ Each box contains 500 pieces
- ◆ PE textured

ITEM	DESCRIPTION	UOM	CASE
GLP-M	Medium	Box	10
GLP-L	Large	Box	10



### WHITE SERVICE GLOVES

- ◆ 100% Cotton

ITEM	DESCRIPTION	UOM	CASE
GLC-M	Medium (6 Pairs)	Doz	100
GLC-L	Large (6 Pairs)	Doz	100

## WALL BRACKETS



WHW-5



WHW-10  
(Gloves not included)

### WIPES BOX BRACKET

ITEM	DESCRIPTION	UOM	CASE
WHW-5	4" x 5" x 8-1/4"	Each	12/24

### GLOVE BOX HOLDER

ITEM	DESCRIPTION	UOM	CASE
WHW-10	10" x 3" x 5"	Each	12/24

## FIRST AID CABINET



SFAC-12



### FIRST AID CABINET

- ◆ Stainless steel with lockable glass door

ITEM	DESCRIPTION	UOM	CASE
SFAC-12	12" x 12" x 4-3/4"	Each	4

## BOX CUTTER



BXC-4



BXC-B100

### RETRACTABLE BOX CUTTER

- ◆ Handy for opening boxes or slicing cardboard
- ◆ Blade retracts into metal safety sleeve



ITEM	DESCRIPTION	UOM	CASE
BXC-4	4"L	Doz	50
BXC-B100	Replacement Blade, 100-Pcs/Pk	Pack	50

**CARPET FLOOR MATS**

- ◆ Vinyl backing prevents curling/ripping and stays flat for safe footing

ITEM	DESCRIPTION	COLOR	UOM	CASE
FMC-310C	3' x 10'	Charcoal	Each	1
FMC-310U	3' x 10'	Burgundy	Each	1
FMC-35C	3' x 5'	Charcoal	Each	1
FMC-35U	3' x 5'	Burgundy	Each	1
FMC-46C	4' x 6'	Charcoal	Each	1
FMC-46U	4' x 6'	Burgundy	Each	1

**FLOOR MATS**

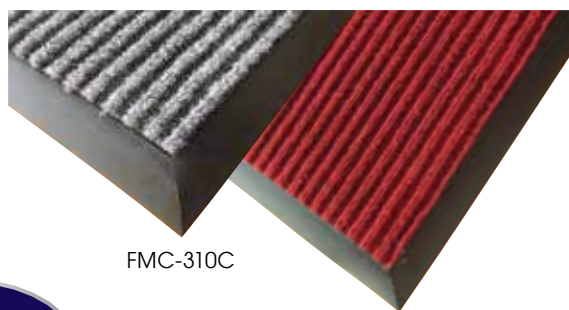

FMC-310C

FMC-310U

**TAPERED,  
WEIGHTED,  
DURABLE**



Lays flat, does not curl/rip with constant foot traffic



Tapered, weighted edge and durable

- ◆ Top-grade rubber
- ◆ Durable for long-term wear

**STRAIGHT EDGE NATURAL RUBBER FLOOR MATS**

- ◆ Grease resistant

ITEM	DESCRIPTION	COLOR	UOM	CASE
RBMH-35K	3' x 5' x 3/4" Anti-Fatigue	Black	Each	1
RBMH-35R	3' x 5' x 3/4" Grease-Proof	Red	Each	1

**RUBBER FLOOR MATS**

**3/4" THICK**

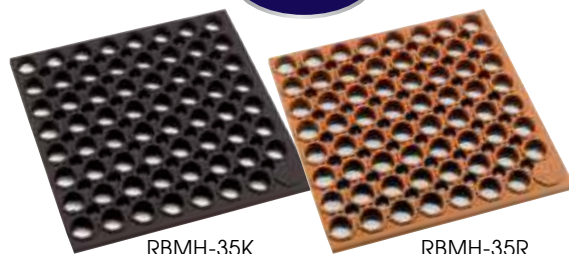

RBMH-35K

RBMH-35R

**BEVELED EDGE RUBBER FLOOR MATS**

ITEM	DESCRIPTION	COLOR	UOM	CASE
RBM-35K	3' x 5' x 1/2"	Black	Each	1
RBM-35R	3' x 5' x 1/2"	Red	Each	1

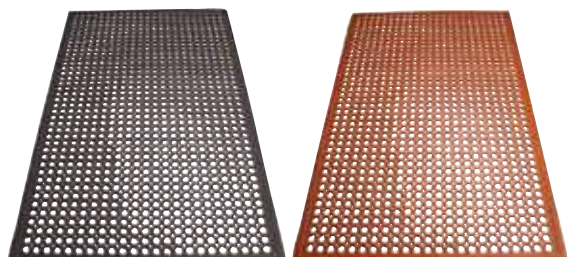

RBM-35K

RBM-35R

**PREMIUM BEVELED EDGE RUBBER FLOOR MAT**

- ◆ Natural rubber

ITEM	DESCRIPTION	COLOR	UOM	CASE
RBMM-35K	3' x 5' x 3/8"	Black	Each	1

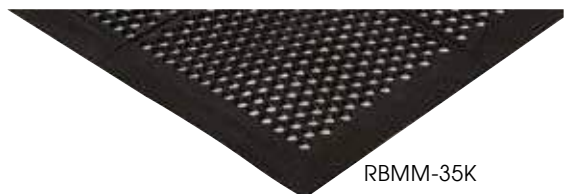

RBMM-35K

**RUBBER INTERLOCKING FLOOR MATS**

ITEM	DESCRIPTION	COLOR	UOM	CASE
RBMI-33K	3' x 3' x 1/2"	Black	Each	1
RBMI-33R	3' x 3' x 1/2"	Red	Each	1



RBMI-33R

WASTE RECEPTACLE



WR-35

WASTE RECEPTACLE

- ◆ Features tray-top design with 9"H self-return door
- ◆ Fits up to 35 gallon capacity trash can
- ◆ Inside dimensions: 32"L x 21"W x 20-3/4"H
- ◆ Ships knocked down
- ◆ Light natural-wood color

ITEM	DESCRIPTION	UOM	CASE
WR-35	23-3/4"L x 23-1/2"W x 44"H	Each	1

SLENDER TRASH CANS

SLENDER TRASH CANS

- ◆ Lid sold separately

ITEM	DESCRIPTION	COLOR	UOM	CASE
PTC-23SG	23 Gallon	Gray	Each	1
PTC-23B	23 Gallon	Brown	Each	1
PTC-23K	23 Gallon, Black	Black	Each	1
PTC-23L	23 Gallon Recycle Can	Blue	Each	1
PTCL-23	Lid for PTC-23SG	Gray	Each	4
PTCL-23B	Lid for PTC-23B	Brown	Each	4
PTCL-23K	Lid for PTC-23K	Black	Each	4
PTCL-23L	Lid for PTC-23L	Blue	Each	4



PTCL-23L



PTCL-23K



PTC-23L



PTC-23K



PTC-23SG



PTC-23B



PTCB-23L



PTCP-23L

SPECIALTY LIDS

ITEM	DESCRIPTION	COLOR	UOM	CASE
PTCB-23L	Bottle/Can Recycling Cover for PTC-23L	Blue	Each	6
PTCP-23L	Paper Recycling Cover for PTC-23L	Blue	Each	6

**WIRE TRASH CAN CART**

Move slender trash cans from one location to another with the ease of a rolling cart built for the task.

- ◆ Capacity up to 400 Lbs
- ◆ Wheels measure 3-3/4" diameter each
- ◆ Compatible with PTC-Series 23 gallon slender trash cans

ITEM	DESCRIPTION	UOM	CASE
DWR-1708	18-1/2"L x 9-1/2"W x 7"H	Each	4

*Shown with PTC-23SG*

**TRASH CAN CART**



Fits standard slim trash cans



DWR-1708

**HEAVY-DUTY TRASH CANS**

- ◆ Lid sold separately

ITEM	DESCRIPTION	COLOR	UOM	CASE
PTC-32G	32 Gallon	Gray	Each	1
PTC-44G	44 Gallon	Gray	Each	1
FCW-10	10 Gallon, NSF	White	Each	6
FCW-20*	20 Gallon, NSF	White	Each	6
FCW-32*	32 Gallon, NSF	White	Each	6

*\*Works with DLR-series dollies (see below section)*

**HEAVY-DUTY TRASH CANS & DOLLIES**



PTC-32G & PTCL-32

**FCW-SERIES ALSO SAFE FOR FOOD STORAGE**



FCW-32 & FCW-32L



FCW-32RC

FCW-SERIES **NSF**

**HEAVY-DUTY TRASH CAN LIDS**

ITEM	DESCRIPTION	COLOR	UOM	CASE
PTCL-32	Lid for PTC-32G	Gray	Each	6
PTCL-44	Lid for PTC-44G	Gray	Each	6
FCW-10L	Lid for FCW-10, NSF	White	Each	24
FCW-20L	Lid for FCW-20, NSF	White	Each	12
FCW-32L	Lid for FCW-32, NSF	White	Each	12
FCW-10RC	Rotating Lid for FCW-10, NSF	White	Each	6
FCW-20RC	Rotating Lid for FCW-20, NSF	White	Each	6
FCW-32RC	Rotating Lid for FCW-32, NSF	White	Each	6

ITEM #	CAPACITY (GALLONS)	CAPACITY (CUPS)	FLOUR (LBS)	SUGAR (LBS)
FCW-10	10	150	47	65
FCW-20	20	300	94	130
FCW-32	32	500	156	217

**EXTRA HEAVY-DUTY DOLLY**

- ◆ Holds up to 900 lbs

ITEM	DESCRIPTION	UOM	CASE
DLR-2	Extra-Heavy Dolly	Each	2
DLR-2-C	Caster for DLR-2	Each	1



DLR-2

**DOLLY**

- ◆ Holds up to 400 lbs

ITEM	DESCRIPTION	UOM	CASE
DLR-18	18"Dia x 6"H, Black	Each	2
DLR-18-W	Caster for DLR-18	Each	1



DLR-18

FLOOR CARE



MPB-36

MPB-36W



WCS-27T

WCS-25

CSF-4 & CSF-SET



WSS-12

WS-15



FSC-60H

FSS-24



MOP-24C

MOP-32W



MOPH-7M

MOPH-7P

MOP BUCKET WITH SIDE PRESS WRINGER

ITEM	DESCRIPTION	UOM	CASE
MPB-36	36 Qt, Yellow	Each	1
MPB-36W	Replacement Wringer for MPB-36	Each	2
MPB-36WH	Caster for MPB-36	Each	4

FLOOR SIGNS

ITEM	DESCRIPTION	UOM	CASE
WCS-27T	27"H, Caution Cone	Each	5
WCS-25	25" x 12", English/Spanish Floor Sign	Each	12
CSF-4	Pop-up Caution Cone	Each	12/48
CSF-SET	Set of CSF-4 and CSF-4H	Set	6/36

SQUEEGEES

ITEM	DESCRIPTION	UOM	CASE
WSS-12	12" with 23" Handle	Each	6/24
WS-15	15" Window Squeegee with Telescopic Handle Aluminum handle extends from 30" to 55"	Each	20
FSS-24	24", Straight Squeegee, Handle sold separately	Each	6
FSC-60H	55" Wooden Handle for FSS-24	Each	6

PREMIUM YARN MOP HEADS

- ◆ Poly-cotton blend
- ◆ 4-ply yarn
- ◆ 1-1/4" narrow band

ITEM	DESCRIPTION	SIZE	UOM	CASE
MOP-24	Blue Loop End	24oz, 600g	Each	20
MOP-32	Blue Loop End	32oz, 800g	Each	20
MOP-24C	Blue Cut End	24oz, 600g	Each	20
MOP-32C	Blue Cut End	32oz, 800g	Each	20
MOP-24W	White Loop End	24oz, 600g	Each	20
MOP-32W	White Loop End	32oz, 800g	Each	20
MOP-24WC	White Cut End	24oz, 600g	Each	20
MOP-32WC	White Cut End	32oz, 800g	Each	20

MOP HANDLES

ITEM	DESCRIPTION	SIZE	UOM	CASE
MOPH-7M	Metal, Quick-Change	57"	Each	6
MOPH-7P	Plastic, Side-Release	57"	Each	6



### FLOOR SCRUB BRUSH

ITEM	DESCRIPTION	UOM	CASE
BRF-10R	10"W	Each	12

### WOODEN HANDLES

ITEM	DESCRIPTION	UOM	CASE
BR-36W	36" O.L. fits BR-10	Each	48
BR-60W	55" O.L. fits BR-10	Each	6/24
FSC-60H	55" O.L. fits FSS-24	Each	6

### LOBBY BROOM & PAN

- ◆ Built-in cover for mess-free transport

ITEM	DESCRIPTION	UOM	CASE
BRM-60L	60"L HdI	Each	12
DP-13C	13"W Pan	Set	10

### DUST MOP

- ◆ 60" aluminum handle
- ◆ Includes frame, mop head and handle

ITEM	DESCRIPTION	UOM	CASE
DM-24	24"W Dust Mop	Each	6
DM-24H	Replacement Head for DM-24, Frame not Included	Each	24

### ROTARY SWEEPER

- ◆ Non-electric rotary sweeper and dust pan with natural bristles and steel handle

ITEM	DESCRIPTION	UOM	CASE
FSW-11	11"L x 7-3/4"W x 43"H	Each	4

### MOP & BROOM RACKS

Maximize space with these mop/broom racks that offer versatile hanging options. Outfitted with non-slip bristles, hooks and clips, they keep kitchen cleaning tools organized and within easy reach.

- ◆ MHH-36 & MHH-24 constructed of aluminum with non-slip rubber bristles that hold tools securely in place
- ◆ MHH-5 constructed of durable ABS plastic with five (5) clips and six (6) hooks

ITEM	DESCRIPTION	UOM	CASE
MHH-5	16"L, 5 Clips and 6 Hooks	Each	12
MHH-24	24"L Mop Rack, Rubber Bristles	Each	6/24
MHH-36	36"L Mop Rack, Rubber Bristles	Each	6/12

### FLOOR CARE



BRF-10R



BR-60W



FSC-60H



BRM-60L



DM-24



FSW-11



DP-13C



MHH-36



MHH-5

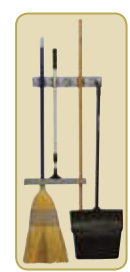

## CLEANING ACCESSORIES



PPL-6G

PPL-6R



PPL-20D



BTGP-21



BTH-2028G



BTM-16AC



BTM-16W

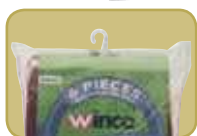

Package comes with hanging hook



BTW-30



SPG-50



PSR-9



SP-96N

### CLEANING BUCKETS

- ◆ Green pail for soap solution
- ◆ Red pail for sanitizing solution
- ◆ Not for use with food products

ITEM	DESCRIPTION	UOM	CASE
PPL-3G	3 Qt, Green	Each	12
PPL-3R	3 Qt, Red	Each	12
PPL-6G	6 Qt, Green	Each	12
PPL-6R	6 Qt, Red	Each	12

### PLASTIC DOUBLE PAIL

- ◆ Wide pour spout with compartments to separate clean wash water from rinse water

ITEM	DESCRIPTION	UOM	CASE
PPL-20D	19.55 Qt, Gray	Each	6

### GLASS POLISHING TOWEL

- ◆ 100% cotton
- ◆ Lint-free and non-abrasive to eliminate streaking, yet is gentle on glassware
- ◆ Thousands of microscopic fibers pick up dirt and dust
- ◆ Absorbs seven times its weight in liquids, also ideal for countertops and tabletops

ITEM	DESCRIPTION	UOM	CASE
BTGP-21	16" x 29", Red Pinstripes	Doz	10/20

### HERRINGBONE BAR TOWEL

- ◆ 100% cotton
- ◆ Super absorbent, ideal for wiping down tables or countertops
- ◆ Green stripe provides easy designation of towel for specific use to prevent cross-contamination

ITEM	DESCRIPTION	UOM	CASE
BTH-2028G	20" x 28"	Doz	10/20

### MICROFIBER BAR & KITCHEN TOWELS

- ◆ Lightweight, absorbent and quick drying
- ◆ BTM-16AC includes white, green, yellow, brown, orange and red
- ◆ Each pack contains six (6) pieces

ITEM	DESCRIPTION	UOM	CASE
BTM-16AC	16" x 16", Assorted Colors	Pack	20
BTM-16W	16" x 16", White	Pack	20

### WHITE BAR TOWEL

- ◆ 100% cotton

ITEM	DESCRIPTION	UOM	CASE
BTW-30	16" x 19"	Doz	10/20

### STAINLESS STEEL SPONGES

ITEM	DESCRIPTION	UOM	CASE
SPG-50	50g	Each	12/144
SPG-105	105g	Each	12/72

### SCOURING PADS

- ◆ Each pack contains six (6) pieces

ITEM	DESCRIPTION	UOM	CASE
SP-96N	6" x 9-3/8", Nylon	Pack	60

### PLASTIC SPRAY BOTTLE

ITEM	DESCRIPTION	UOM	CASE
PSR-9	28 Oz, 900 ml	Each	50

**HAACP COLOR-CODED CUTTING BOARD BRUSHES**

ITEM	DESCRIPTION	UOM	CASE
CBR-WT	White	Each	24/96
CBR-BN	Brown	Each	24/96
CBR-BU	Blue	Each	24/96
CBR-GR	Green	Each	24/96
CBR-RD	Red	Each	24/96
CBR-YL	Yellow	Each	24/96

**BRUSHES**



CBR-SERIES



**BEER MUG WASHER**

Eliminate hand-scrubbing glassware with Winco's Beer Mug Washer. The long-lasting nylon bristles are tough enough to get out grime, yet soft enough to not scratch or damage glass. Four suction feet hold to surfaces, preventing movement while in use.

- ◆ Features one glass washer in the center with additional scrubbing bristles on the sides
- ◆ Wide enough to accommodate a beer mug & the handle
- ◆ Dirty water can be drained through detachable hose
- ◆ Durable plastic construction at space-saving size

ITEM	DESCRIPTION	UOM	CASE
GWB-1	Beer Mug Washer	Each	6



GWB-1

**GLASS WASHER BRUSHES**

- ◆ Four suction feet provide stability on slippery surfaces
- ◆ Dishwasher safe

ITEM	DESCRIPTION	UOM	CASE
GWB-3	3 Brushes with Base	Each	12
GWB-3-BR	Brush for GWB-3	Each	100



GWB-3

GWB-3-BR

**COFFEE DECANTER BRUSH**

- ◆ Brush head: 1-1/4" diameter

ITEM	DESCRIPTION	UOM	CASE
CDB-11	11" O.L.	Each	12/96



CDB-11

BR-24

BR-25

BR-28

**EQUIPMENT BRUSHES**

ITEM	DESCRIPTION	UOM	CASE
BR-24	24-1/2" L-Shaped Fryer Brush	Each	12/96
BR-25	25" Urn Brush	Each	12/96
BR-28	28-1/4" Kettle Valve Brush	Each	12/96

**POT SCRUBBING BRUSHES**

- ◆ Plastic handle with nylon bristles

ITEM	DESCRIPTION	UOM	CASE
BRN-8P	8"	Each	12/72
BRN-20P	20"	Each	12/72

**ALL PURPOSE CLEAN-UP BRUSHES**

**POT BRUSHES**

- ◆ Wooden handle with coir bristles

ITEM	DESCRIPTION	UOM	CASE
BRP-10	10"	Each	12/72
BRP-20	20"	Each	6/48



BRN-8P

BRN-20P

BRP-10

BRP-20



## OVEN & BROILER BRUSHES



BR-27



BR-30



BR-31



BR-21



BR-10



BR-36W

BR-60W



BR-9



BR-12

### PIZZA OVEN SCRAPER

- ◆ Carbon wire brush and scraper

ITEM	DESCRIPTION	UOM	CASE
BR-27	Scraper with 27" Hdl	Each	12

### PIZZA OVEN/BROILER BRUSH

- ◆ Stiff stainless steel wire bristles make cleaning heavy oven residue effortless
- ◆ Quick and easy removal of heavy carbon deposits, rust and burned-on food buildup

ITEM	DESCRIPTION	UOM	CASE
BR-30	Brush w/30" Hdl	Each	8/32

### COMMERCIAL BROILER BRUSH

- ◆ 1-1/4" L steel wire bristles
- ◆ Beechwood brush base (7-11/16" L x 2-19/32" W x 1-1/64" H)
- ◆ 3/4" diameter zinc-plated iron handle

ITEM	DESCRIPTION	UOM	CASE
BR-31	31" O.L.	Each	12



### DUAL-HEAD BRUSH

- ◆ 1-1/2" L steel wire bristles on thick brush
- ◆ 1-1/4" L flat steel wire bristles on thin brush

ITEM	DESCRIPTION	UOM	CASE
BR-21	Dual-Headed Brush with 28" S/S Handle	Each	6

### PIZZA OVEN BRUSH HEAD

- ◆ Brass bristles with scraper

ITEM	DESCRIPTION	UOM	CASE
BR-10	Brush Head, 10-1/4" x 1-3/8" x 1-3/4"	Each	12/48
BR-36W	36" Wdn Hdl fits BR-10	Each	48
BR-60W	55" Wdn Hdl fits BR-10	Each	6/24

### BUTCHER BLOCK BRUSH

ITEM	DESCRIPTION	UOM	CASE
BR-9	Steel Bristles	Each	6/12

### OVEN & GRILL/BBQ BRUSH

ITEM	DESCRIPTION	UOM	CASE
BR-12	12" O.L., Brass Bristles	Each	12/72

**ALUMINUM GRILL SCRAPER**

A great way to clean the grill quickly and safely. The handle is designed to keep hands and fingers away from the hot grill surface.

ITEM	DESCRIPTION	BLADE	UOM	CASE
SCRP-16	16" Scraper	5"	Each	6
SCRP-5B	Replacement Blade for SCR-16		Each	12/48

**GRILL MAINTENANCE**



**ECONOMY GRILL SCRAPER**

ITEM	DESCRIPTION	BLADE	UOM	CASE
SCRP-12	12" Alu Scraper	4"	Each	12/72
SCRP-4B	Replacement Blades for SCR-12, 10-Pcs/Pk		Pack	10/100



**GRIDDLE CLEANERS**

ITEM	DESCRIPTION	UOM	CASE
GSH-1	Griddle Screen Holder, 5" x 2-3/4"	Each	12/48
GSN-4	Grill Screen, Fits with GSH-1; 4" x 5-1/2", 20 pcs/pk;	Pack	20/80
GBH-2	Griddle Brick Holder, 7" x 3-1/2"	Each	6/72
GBK-348	Grill Brick, Fits with GBH-2; 3-1/2" x 4" x 8"	Doz	1

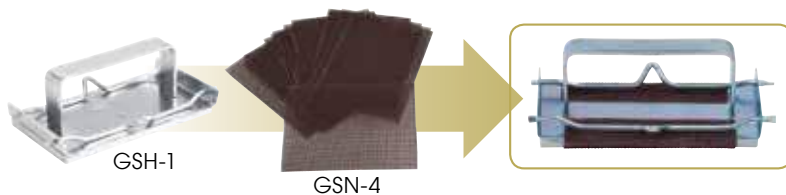

**MINI UTILITY BRUSHES**

◆ Ideal for cleaning ceramic tiles and narrow spaces

ITEM	DESCRIPTION	UOM	CASE
BR-7B	7" O.L., Brass Bristles	Each	48/576
BR-7S	7" O.L., S/S Wire Bristles	Each	48/576

**SCRATCH BRUSHES**



**SCRATCH BRUSHES**

ITEM	DESCRIPTION	UOM	CASE
BR-319	14" O.L., Steel Bristles	Doz	12
BR-500	20" O.L., Wire Bristles	Each	6/48

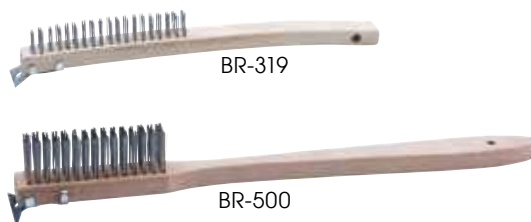

**RESTROOM NECESSITIES**



TD-600



TD-700



TD-300



TD-330



TD-500



AFD-1



SD-100



**PAPER TOWEL CABINETS**

- ◆ Dispenses 400 C-Fold or 525 M-fold towels (3-1/8" to 3-13/16") without adjustments or adapters

ITEM	DESCRIPTION	UOM	CASE
TD-600	White Epoxy-Coated Iron	Each	6
TD-700	Stainless Steel	Each	6

**M-FOLD PAPER TOWEL DISPENSER**

- ◆ Dispenser accommodates paper pack size of 8-1/2" x 3-1/8" x 6" (maximum of 200 pieces) with an approximate weight of 0.88 lbs

ITEM	DESCRIPTION	UOM	CASE
TD-300	Fits M/C-Fold	Each	10

**PAPER TOWEL DISPENSER**

- ◆ Dispenser accommodates a paper roll size of 7-7/8" Dia x 7-7/8"L with an approximate weight of 3.19 lbs

ITEM	DESCRIPTION	UOM	CASE
TD-330	Center-Pull	Each	6

**PAPER TOWEL DISPENSER, LEVER HANDLE**

- ◆ Dispenser accommodates a paper roll size of 7-1/2" Dia x 7-7/8"L with an approximate weight of 3.30 lbs

ITEM	DESCRIPTION	UOM	CASE
TD-500	Fits 7-1/2" Dia Paper Roll	Each	3



**AUTOMATIC AIR FRESHENER**

- ◆ Fully programmable dispenser
- ◆ Spray intervals are 5, 10, 15 or 30 minutes
- ◆ Working time setting options are day, night or 24 hours
- ◆ Accommodates standard size 6.6 oz refill sprays (not included)

ITEM	DESCRIPTION	UOM	CASE
AFD-1	Automatic Intervals	Each	6/24

**MANUAL SOAP DISPENSER**

ITEM	DESCRIPTION	UOM	CASE
SD-100	1 Liter, Wall Mount	Each	24

**RESTROOM NECESSITIES**

**TWIN ROLLS TOILET TISSUE DISPENSER**

◆ Dispenser accommodates two tissue paper rolls, each with an approximate size of 9-1/2" Dia x 4"H and each with an approximate weight of 1.71 lbs

ITEM	DESCRIPTION	UOM	CASE
TD-220	Twin Rolls	Each	3



TD-220

**JUMBO ROLL PAPER DISPENSERS**

◆ Dispenser accommodates a tissue paper roll with an approximate weight of 4.18 lbs

ITEM	DESCRIPTION	UOM	CASE
TD-120	14"Dia	Each	3
TD-120S	11"Dia	Each	6



TD-120S



TTH-1



TTH-2



**TOILET TISSUE HOLDERS**

◆ Chrome-plated steel

ITEM	DESCRIPTION	UOM	CASE
TTH-1	Single Roll	Each	36
TTH-2	Double Roll	Each	24

**TOILET SEAT COVERS**

ITEM	DESCRIPTION	UOM	CASE
TSC-10	Half-Fold Dispenser	Each	20
TSC-250	Half-Fold Covers, 250-Pcs/Bag	Bag	20



TSC-10



TSC-250

**RUBBER PLUNGER WITH WOODEN HANDLE**

ITEM	DESCRIPTION	UOM	CASE
TP-300	19" O.L.	Each	48



TP-300

**TOILET BRUSH WITH PLASTIC HANDLE**

ITEM	DESCRIPTION	UOM	CASE
BR-15	12" O.L.	Each	12/48



BR-15

**URINAL SCREEN WITH DEODORIZER BLOCK**

ITEM	DESCRIPTION	UOM	CASE
USF-4	Screen & Deodorizer	Each	12/144



USF-4



## HOOD FILTERS



HFS-1620

HFS-1625

HFS-2020

## STAINLESS STEEL HOOD FILTERS

ITEM	DESCRIPTION	UOM	CASE
HFS-1620	16"L x 20"W	Each	6
HFS-1625	16"L x 25"W	Each	6
HFS-2016	20"L x 16"W	Each	6
HFS-2020	20"L x 20"W	Each	6
HFS-2025	20"L x 25"W	Each	6

## INSECT CONTROL



EIZ-1E

EIZ-2G

### INSECT ZAPPER

- ◆ UVA bulbs attract insects to cylinder, high voltage kills them
- ◆ Made for indoor or outdoor use
- ◆ 1,600 ft range

ITEM	DESCRIPTION	UOM	CASE
EIZ-1E	Electric Insect Zapper	Each	1

### INSECT TRAPPER

- ◆ Two shatter-proof 15W UV lamps attract insects to glue board
- ◆ Eco-friendly; no toxic chemical emissions
- ◆ Conforms to international hygiene standards
- ◆ 1,100 ft range

ITEM	DESCRIPTION	UOM	CASE
EIZ-2G	Insect Glue Trap	Each	4
EIZ-2G-GB	Glue Board for EIZ-2G	Each	50/250

## JANITORIAL ACCESSORIES



OP-7

POA-8

SIK-3

RSB-6

PF-32

SF-6

SF-6S

### PAIL OPENER

- ◆ Aluminum

ITEM	DESCRIPTION	UOM	CASE
POA-8	8-7/16" x 1-7/16" x 2-3/4"	Each	6/72

### SINK STRAINER

- ◆ Stainless steel

ITEM	DESCRIPTION	UOM	CASE
SIK-3	3"Dia w/Stopper	Each	24/144

### OVERFLOW PIPES

ITEM	DESCRIPTION	UOM	CASE
OP-7	7"L x 1"Dia	Each	24/288
OP-11	11"L x 1"Dia	Each	12/144

### RUBBER SCRAP BLOCK

ITEM	DESCRIPTION	UOM	CASE
RSB-6	6-1/2"Dia x 4"H	Each	12

### PLASTIC FUNNELS

ITEM	DESCRIPTION	UOM	CASE
PF-8	4"Dia	Each	6/324
PF-16	5-1/4"Dia	Each	6/324
PF-32	6-1/4"Dia	Each	6/216

### WIDE MOUTH FUNNELS & REMOVABLE STRAINERS

- ◆ Stainless steel mirror finish for SF-5 and SF-6

ITEM	DESCRIPTION	UOM	CASE
SF-5	5"Dia	Each	12/72
SF-6	5-3/4"Dia	Each	12/72
SF-6S	Strainer for SF-6	Each	120/480



## WIRE SHELVING SETS

- ◆ Shelving set includes four (4) shelves and four (4) 72" high posts
- ◆ Heavy-duty wire construction
- ◆ Bright chrome-plated / epoxy-coated finish to reduce dust and dirt accumulation
- ◆ Easy to assemble, no tools required
- ◆ Withstands temperatures from -100°F to 500°F
- ◆ Capacities: under 48" in length, up to 850 lbs per shelf; over 48" in length, up to 600 lbs per shelf

### CHROME-PLATED WIRE SHELVING SET

- ◆ NSF listed for use in dry storage and heated environments

ITEM	DESCRIPTION	UOM	CASE
VCS-1836	18" x 36"	Set	1
VCS-1848	18" x 48"	Set	1
VCS-2436	24" x 36"	Set	1
VCS-2448	24" x 48"	Set	1



VCS-SERIES NSF

### EPOXY COATED WIRE SHELVING SET

- ◆ NSF listed for use in all environments, including humid areas

ITEM	DESCRIPTION	UOM	CASE
VEXS-1836	18" x 36"	Set	1
VEXS-1848	18" x 48"	Set	1
VEXS-2436	24" x 36"	Set	1
VEXS-2448	24" x 48"	Set	1



VEXS-SERIES NSF

### 3-TIER WIRE SHELVING CARTS

Winco's sturdy shelving now comes in a full cart set! Unlike traditional carts that have fixed heights, these wire shelving carts are height-adjustable to fit your storage needs.

- ◆ Includes three (3) adjustable-height shelves
- ◆ Capacity up to 800 Lbs
- ◆ Step-lock feature on two casters
- ◆ Ships knocked down

ITEM	DESCRIPTION	UOM	CASE
VCCD-1836B	18" x 36"	Set	1
VCCD-2448B	24" x 48"	Set	1



NEW



VCCD-1836B

### MOBILE SHELVING EXTENSION HANDLE

- ◆ Use extension handles on mobile units for easy transport
- ◆ Includes two (2) sleeve clips per handle

ITEM	DESCRIPTION	UOM	CASE
VCH-14	14"W	Each	12
VCH-18	18"W	Each	12
VCH-21	21"W	Each	12
VCH-24	24"W	Each	12



VCH-24

## WIRE SHELVES

- ◆ NSF listed for use in dry storage and heated environments
- ◆ Heavy-duty wire construction
- ◆ Bright chrome-plated finish reduces dust and dirt accumulation
- ◆ Mix-and-match the various sizes to suit any need
- ◆ Easy to assemble, no tools required
- ◆ Capacities: under 48" in length, up to 850 lbs per shelf; over 48" in length, up to 600 lbs per shelf
- ◆ Includes four (4) sleeve clips per shelf



**NSF** VC-SERIES SHELVES



Customize the Chrome-Plated Wire Shelves to accommodate all of your storage needs

**NEW SIZES**



**NSF** VC-SERIES POSTS



VCB-SERIES WALL MOUNT BRACKET



VC-HK



## CHROME-PLATED WIRE SHELVES

- ◆ Withstands temperatures from -100°F to 500°F
- ◆ Must purchase in multiples of two (2)
- ◆ NSF listed

ITEM	DESCRIPTION (WxL)	UOM	CASE
VC-1424	14" x 24"	Each	2
VC-1430	14" x 30"	Each	2
VC-1436	14" x 36"	Each	2
VC-1448	14" x 48"	Each	2
VC-1460	14" x 60"	Each	2
VC-1472	14" x 72"	Each	2
VC-1824	18" x 24"	Each	2
VC-1830	18" x 30"	Each	2
VC-1836	18" x 36"	Each	2
VC-1842	18" x 42"	Each	2
VC-1848	18" x 48"	Each	2
VC-1854	18" x 54"	Each	2
VC-1860	18" x 60"	Each	2
VC-1872	18" x 72"	Each	2
VC-2124	21" x 24"	Each	2
VC-2130	21" x 30"	Each	2
VC-2136	21" x 36"	Each	2
VC-2148	21" x 48"	Each	2
VC-2160	21" x 60"	Each	2
VC-2172	21" x 72"	Each	2
VC-2424	24" x 24"	Each	2
VC-2430	24" x 30"	Each	2
VC-2436	24" x 36"	Each	2
VC-2442	24" x 42"	Each	2
VC-2448	24" x 48"	Each	2
VC-2454	24" x 54"	Each	2
VC-2460	24" x 60"	Each	2
VC-2472	24" x 72"	Each	2

## CHROME-PLATED POSTS



- ◆ For wire shelving
- ◆ Must purchase in multiples of four (4)
- ◆ Withstands temperatures from -100°F to 500°F
- ◆ NSF listed

ITEM	DESCRIPTION	UOM	CASE
VC-8P	8"H	Each	4
VC-34P	34"H	Each	4
VC-48P	48"H	Each	4
VC-54P	54"H	Each	4
VC-63P	63"H	Each	4
VC-72P	72"H	Each	4
VC-86P	86"H	Each	4

## CHROME-PLATED WALL MOUNT BRACKETS

- ◆ Brackets for mounting single wire shelving
- ◆ Each pack contains two (2) pieces

ITEM	DESCRIPTION	UOM	CASE
VCB-14	14"W	Pair	2
VCB-18	18"W	Pair	2
VCB-21	21"W	Pair	2
VCB-24	24"W	Pair	2

## S/N-STYLE HOOK FOR CHROME-PLATED SHELVING

- ◆ Holds shelves together when standing next to each other

ITEM	DESCRIPTION	UOM	CASE
VC-HK	S/N Hook for VC-series Shelves	Each	20/200



### EPOXY-COATED WIRE SHELVES

- ◆ Withstands temperatures from -100°F to 500°F
- ◆ Must purchase in multiples of two (2)
- ◆ NSF listed

ITEM	DESCRIPTION (WxL)	UOM	CASE
VEX-1424	14" x 24"	Each	2
VEX-1430	14" x 30"	Each	2
VEX-1436	14" x 36"	Each	2
VEX-1448	14" x 48"	Each	2
VEX-1460	14" x 60"	Each	2
VEX-1472	14" x 72"	Each	2
VEX-1824	18" x 24"	Each	2
VEX-1830	18" x 30"	Each	2
VEX-1836	18" x 36"	Each	2
VEX-1842	18" x 42"	Each	2
VEX-1848	18" x 48"	Each	2
VEX-1854	18" x 54"	Each	2
VEX-1860	18" x 60"	Each	2
VEX-1872	18" x 72"	Each	2
VEX-2124	21" x 24"	Each	2
VEX-2130	21" x 30"	Each	2
VEX-2136	21" x 36"	Each	2
VEX-2148	21" x 48"	Each	2
VEX-2160	21" x 60"	Each	2
VEX-2172	21" x 72"	Each	2
VEX-2424	24" x 24"	Each	2
VEX-2430	24" x 30"	Each	2
VEX-2436	24" x 36"	Each	2
VEX-2442	24" x 42"	Each	2
VEX-2448	24" x 48"	Each	2
VEX-2454	24" x 54"	Each	2
VEX-2460	24" x 60"	Each	2
VEX-2472	24" x 72"	Each	2



### EPOXY-COATED POSTS

- ◆ For wire shelving
- ◆ Must purchase in multiples of four (4)
- ◆ Withstands temperatures from -100°F to 500°F
- ◆ NSF listed

ITEM	DESCRIPTION	UOM	CASE
VEX-8P	8"H	Each	4
VEX-34P	34"H	Each	4
VEX-48P	48"H	Each	4
VEX-54P	54"H	Each	4
VEX-63P	63"H	Each	4
VEX-72P	72"H	Each	4
VEX-86P	86"H	Each	4

### EPOXY-COATED WALL MOUNT BRACKETS

- ◆ Brackets for mounting single wire shelving
- ◆ Each pack contains two (2) pieces

ITEM	DESCRIPTION	UOM	CASE
VEXB-14	14"W	Pair	2
VEXB-18	18"W	Pair	2
VEXB-21	21"W	Pair	2
VEXB-24	24"W	Pair	2

### S/N-STYLE HOOK FOR EPOXY-COATED SHELVING

- ◆ Holds shelves together when standing next to each other

ITEM	DESCRIPTION	UOM	CASE
VEX-HK	S/N Hook for VEX-series Shelves	Each	20/200

## WIRE SHELVES

- ◆ NSF listed for use in all environments, including humid areas
- ◆ Heavy-duty wire construction
- ◆ Bright epoxy-coated finish reduces dust and dirt accumulation
- ◆ Mix-and-match the various sizes to suit any need
- ◆ Easy to assemble, no tools required
- ◆ Capacities: under 48" in length, up to 850 lbs per shelf; over 48" in length, up to 600 lbs per shelf
- ◆ Includes four (4) sleeve clips per shelf



VEX-SERIES SHELVES



Customize the Epoxy Coated Wire Shelves to accommodate all of your storage needs



VEX-SERIES POSTS

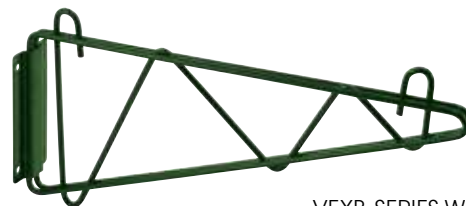

VEXB-SERIES WALL MOUNT BRACKET



VEX-HK



## SHELVING MATS



VM-SERIES

### SHELVING MATS

- ◆ Creates a solid surface for wire shelves to prevent small debris and leaks from falling through
- ◆ Protects epoxy coated shelves from scratches
- ◆ 0.75mm thick polypropylene
- ◆ 4-Pcs/Pk

ITEM	DESCRIPTION (WxL)	UOM	CASE
VM-1424	14" x 24"	Pack	4
VM-1436	14" x 36"	Pack	4
VM-1448	14" x 48"	Pack	4
VM-1460	14" x 60"	Pack	4
VM-1824	18" x 24"	Pack	4
VM-1836	18" x 36"	Pack	4
VM-1848	18" x 48"	Pack	4
VM-1860	18" x 60"	Pack	4
VM-2424	24" x 24"	Pack	4
VM-2436	24" x 36"	Pack	4
VM-2448	24" x 48"	Pack	4
VM-2460	24" x 60"	Pack	4

## SHELVING PARTS & ACCESSORIES



VC-LF



VC-SC2



VC-FP



VC-CT



VC-CTB

### PARTS FOR WIRE SHELVING

- ◆ Secure shelving to floors
- ◆ Each pack contains four (4) pieces

ITEM	DESCRIPTION	UOM	CASE
VC-LF	Shelf Leveling Foot	Pack	100
VC-SC2	Shelf Sleeve Clips	Pack	150

### SHELVING FOOT PLATE

- ◆ Secure shelving to floors
- ◆ Each pack contains four (4) pieces

ITEM	DESCRIPTION	UOM	CASE
VC-FP	Foot Plate w/Screws	Pack	100

### CASTERS FOR WIRE SHELVING

- ◆ 5" diameter

ITEM	DESCRIPTION	UOM	CASE
VC-CT	Caster	Each	4/24
VC-CTB	Casters with Brake	Each	4/24

## DUNNAGE RACKS



ASDR-1424



ASDR-SERIES



ADRK-2036



ADRK-SERIES

### ALUMINUM DUNNAGE RACKS

- ◆ Great for storing items off the floor in any environment
- ◆ NSF listed



ITEM	DESCRIPTION	SIZE (L X W X H)	UOM	CASE
ASDR-1424	Holds up to 1200 Lbs	14" x 24" x 8"	Each	8
ASDR-2036	Holds up to 1800 Lbs	20" x 36" x 8"	Each	6
ASDR-2048	Holds up to 1500 Lbs	20" x 48" x 8"	Each	6
ASDR-2060	Holds up to 1200 Lbs	20" x 60" x 8"	Each	6
ADRK-2036	Holds up to 1800 Lbs	20" x 36" x 12"	Each	6
ADRK-2048	Holds up to 1500 Lbs	20" x 48" x 12"	Each	6
ADRK-2060	Holds up to 1200 Lbs	20" x 60" x 12"	Each	6

Made for the most demanding restaurant kitchens, aluminum sheet pan racks from Winco accommodate standard full-size 18" x 26" sheet/bun pans, or twice the capacity for half-size 18" x 13" pans. All racks are shipped knocked down and require assembly, except for the welded series.

## ALUMINUM SHEET PANS & BUN RACKS

### WELDED SHEET PAN RACKS

- ◆ Featuring Winco's exclusive Weld<sup>2</sup> Dual Weldment System
- ◆ Heavy-duty caster wheels to handle loads up to 650 lbs
- ◆ NSF listed

ITEM	DESCRIPTION	UOM	CASE
 AWRK-10	10 Tier, 3" Spacing	Each	1
 AWRK-20	20 Tier, 3" Spacing	Each	1



Winco's exclusive Weld<sup>2</sup> System features fail-safe rigidity through both bolting and welding at both critical joints, to prevent warping with long term, high-traffic use



Specialty bolts secure each joint





Bolt caps are welded over completely to form extra strength juncture

AWRK-20  
\*10 Tier Available

ALRK/AWRK-SERIES 



### SHEET PAN RACKS WITH BRAKES

- ◆ Ships knocked down
- ◆ NSF listed

ITEM	DESCRIPTION	UOM	CASE
 ALRK-10BK	10 Tier, 3" Spacing, NSF	Each	1
 ALRK-20BK	20 Tier, 3" Spacing, NSF	Each	1
 ALRK-30BK	30 Tier, 2" Spacing (w/ heavy weight casters)	Set	1

### SHEET PAN RACKS

- ◆ Ships knocked down
- ◆ NSF listed

ITEM	DESCRIPTION	UOM	CASE
 ALRK-10	10-Tier w/o Brake	Each	1
 ALRK-20	20-Tier w/o Brake	Each	1

### SHEET PAN RACK ACCESSORIES

ITEM	DESCRIPTION	UOM	CASE
ALRK-10-CV	Cover for 10 Tier Rack	Each	12
ALRK-20-CV	Cover for 20 and 30 Tier Racks	Each	12
ALRC-5ST	Caster for ALRK and AWRK-series	Each	12
ALRC-5STK	Caster w/Brake for ALRK & AWRK-series	Each	12
ALRC-5H	Caster for ALRK-30BK, Heavy Weight	Each	12
ALRC-5HK	Caster w/Brake for ALRK-30BK, Heavy Weight	Each	12

### REPLACEMENT CASTERS FOR SHEET PAN RACKS

ITEM	ALRK-3	ALRK-15	ALRK-10	ALRK-20	ALRK-10BK	ALRK-20BK	ALRK-30BK	AWRK-10	AWRK-20
ALRC-5P	4								
ALRC-5ST		2	4	4	2	2		4	2
ALRC-5STK		2			2	2			2
ALRC-5H							2		
ALRC-5HK							2		



ALRK-30BK  ALRK-10BK  ALRK-20BK 



ALRC-5STK  
5" caster with brake



ALRK-10-CV



ALRK-20-CV



ALRK-10 



ALRK-20 

## COUNTER-HEIGHT SHEET PAN RACK



NSF ALRK-15

## SHEET PAN TRUCK



NSF ALRK-3

## WIRE DOLLY



Transport dough boxes

SEE PAGE 172 FOR DOUGH BOXES

NEW



DWR-2617



## COUNTER-HEIGHT SHEET PAN RACK

- ◆ Rack has slides and a hard top that can be used as cutting board stand
- ◆ 14 gauge 6063 aluminum with 1" extruded tube frame
- ◆ Full swivel casters, 5" diameter x 1-1/4"
- ◆ Capacity is 15 full-size (18" x 26") or 30 half-size (18" x 13") sheet pans (not included)
- ◆ Ships knocked down

ITEM	DESCRIPTION	UOM	CASE
ALRK-15	20-7/8"W x 26-1/8"D x 31-5/8"H	Set	1



## SHEET PAN TRUCK

- ◆ 14 gauge 6063 aluminum with 1" extruded aluminum tube frame
- ◆ Full swivel casters, 5" diameter x 1-1/4" width
- ◆ Capacity is 54 full-size (18" x 26") or 108 half-size (13" x 18") sheet pans (not included)
- ◆ Ships knocked down

ITEM	DESCRIPTION	UOM	CASE
ALRK-3	20-5/8"W x 28-7/8"D x 33-3/8"H	Set	1
ALRC-5P	Replacement Caster for ALRK-3, No Retail Pkg.	Each	12

## WIRE DOUGH BOX DOLLY

Transport multiple dough boxes with ease using this wire dolly, currently the only one on the market!

- ◆ Capacity up to 400 lbs
- ◆ Winco® exclusive
- ◆ Wheels measure 3-3/4" Dia each



ITEM	DESCRIPTION	UOM	CASE
DWR-2617	27"L x 18-1/4"W x 2-1/2"H	Each	1

## UNIVERSAL CASTERS

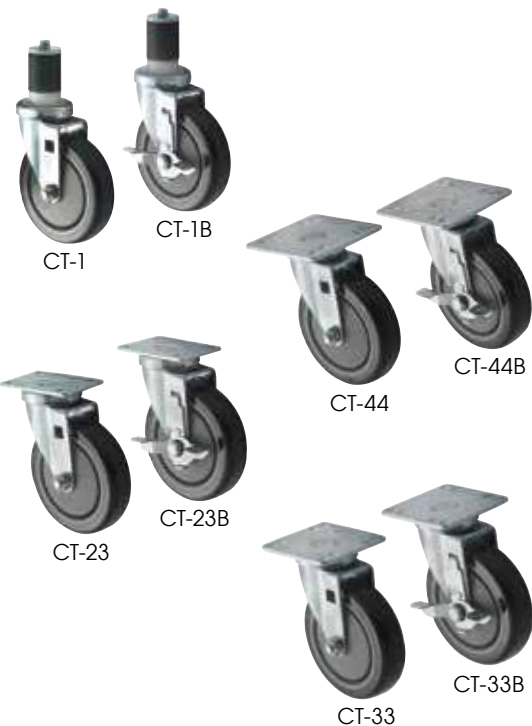

## UNIVERSAL CASTERS, EXTRA HEAVY-DUTY

- ◆ Great for use with most appliances including ranges or walk-in refrigerators
- ◆ Polyurethane, skid-free - will not mark floors
- ◆ High-quality grease-resistant wheel
- ◆ Temperature range from 14°F to 212°F
- ◆ 5" diameter wheels (will raise height of equipment by 6")
- ◆ Wheel capacity: 220 lbs each
- ◆ CT-1 and CT-1B fit standard 1-5/8" or 1-1/2" tubing
- ◆ Shipped in packs of two (2) pieces per set

ITEM	DESCRIPTION	PLATE SIZE	UOM	CASE
CT-1	Worktable Stem Caster Set		Set	12
CT-1B	Worktable Stem Caster Set With Brake		Set	12
CT-23	Universal Plate Caster Set	2-3/8" x 3-5/8"	Set	12
CT-23B	Universal Plate Caster Set With Brake	2-3/8" x 3-5/8"	Set	12
CT-33	Universal Plate Caster Set	3-1/2" x 3-1/2"	Set	12
CT-33B	Universal Plate Caster Set With Brake	3-1/2" x 3-1/2"	Set	12
CT-44	Universal Plate Caster Set	4" x 4"	Set	12
CT-44B	Universal Plate Caster Set With Brake	4" x 4"	Set	12

### FLATWARE CYLINDERS & HOLDERS

ITEM	DESCRIPTION	UOM	CASE
FC-PL	Perforated, Plastic	Each	36/144
FC-SS	Perforated, S/S	Each	20/80
FC-SL	Solid, S/S	Each	20/80
FC-4H	4-Holes/2-Tier Holder, S/S	Each	4
FC-6H	6-Holes/2-Tier Holder, S/S	Each	2

### CUTLERY ORGANIZERS

ITEM	DESCRIPTION	UOM	CASE
OGZ-6	Organizer Bin Set	Set	1
OGZ-1B	Bin for OGZ-6	Each	6

### CUTLERY COMPARTMENT BINS

ITEM	DESCRIPTION	UOM	CASE
PL-4B	Plastic	Each	12
SCB-4	Stainless Steel	Each	8

### CUTLERY DISHWASHER BASKET

- ◆ Eight (8) compartments, molded-in handles
- ◆ NSF listed

ITEM	DESCRIPTION	UOM	CASE
PCB-8	17" x 8" x 6"	Each	12



PL-4B



SCB-4



PCB-8



### FLATWARE ORGANIZERS



FC-4H



FC-PL



FC-SS



FC-SL



OGZ-6

### DISH CADDY

- ◆ Rounded corner design made of polyethylene helps prevent impact damage to surrounding furnishings while caddy is in transit
- ◆ 6 adjustable divider posts allow caddy to hold trays, plates and a wide array of dish sizes
- ◆ Each column holds 45-60 plates with a diameter of 4-1/2" to 13"
- ◆ Sure-grip handle for easy and safe transporting
- ◆ Includes cover



ITEM	DESCRIPTION	UOM	CASE
DCA-6	30-5/6"L x 27-1/2"W x 25-1/8"H	Set	1
DCA-C10	10" Caster for DCA-6	Each	1
DCA-C5B	5" Brake Caster for DCA-6	Each	1



4 columns 4-1/2" plates  
2 columns 5-1/2" - 7" plates  
2 columns 7" - 9" plates



4 columns 9"-13" plates



6 columns 7" - 9" plates



6 columns 5-1/2" - 7" plates



5 columns 5" plates  
2 columns 9"-13" plates



5 columns 4-1/2" plates  
3 columns 7" - 9" plates

### DISH CADDY



DCA-6



Includes vinyl cover



## HEAVYWEIGHT DISH BOXES



PLW-7W



PLW-7G



PLW-7K

## HEAVYWEIGHT DISH BOXES

- ◆ Larger, thicker and stronger than standard dish boxes
- ◆ Polypropylene
- ◆ Freezer safe
- ◆ BPA-free
- ◆ NSF listed

ITEM	DESCRIPTION	COLOR	UOM	CASE
PLW-7G	21" x 17" x 7"	Gray	Each	1
PLW-7K	21" x 17" x 7"	Black	Each	1
PLW-7W	21" x 17" x 7"	White	Each	1
PLW-CG	Cover	Gray	Each	12
PLW-CK	Cover	Black	Each	12
PLW-CW	Cover	White	Each	12



PLW-SERIES

## STANDARD DISH BOXES



## STANDARD DISH BOXES

- ◆ Polypropylene
- ◆ BPA-free
- ◆ NSF listed

ITEM	DESCRIPTION	COLOR	UOM	CASE
PL-5G	20-1/4" x 15-1/2" x 5"	Gray	Each	1
PL-5K	20-1/4" x 15-1/2" x 5"	Black	Each	1
PL-5W	20-1/4" x 15-1/2" x 5"	White	Each	1
PL-7G	21-1/2" x 15" x 7"	Gray	Each	1
PL-7B	21-1/2" x 15" x 7"	Brown	Each	1
PL-7K	21-1/2" x 15" x 7"	Black	Each	1
PL-7W	21-1/2" x 15" x 7"	White	Each	1
PL-57C	Cover	Gray	Each	12
PL-57B	Cover	Brown	Each	12
PL-57K	Cover	Black	Each	12
PL-57W	Cover	White	Each	12



PL-SERIES



## DISH/BUS BOXES

### HEAVYWEIGHT DIVIDED BUS BOXES

- ◆ Two (2) compartments
- ◆ Economical storage for heavy loads
- ◆ Rounded corners for easy cleaning
- ◆ Polypropylene
- ◆ BPA-free

ITEM	DESCRIPTION	COLOR	UOM	CASE
PLTC-7G	21" x 16-3/4" x 6-1/2"	Gray	Each	1
PLTC-7K	21" x 16-3/4" x 6-1/2"	Black	Each	1



PLTC-7K

PLTC-SERIES **BPA FREE**

### HEAVYWEIGHT PERFORATED BUS BOXES

- ◆ Drains easily to eliminate excess water
- ◆ Ideal for thawing food
- ◆ Polypropylene
- ◆ BPA-free

ITEM	DESCRIPTION	COLOR	UOM	CASE
PLP-5G	21-1/4" x 15-3/8" x 4-7/8"	Gray	Each	1
PLP-5W	21-1/4" x 15-3/8" x 4-7/8"	White	Each	1



PLP-5W

PLP-SERIES **BPA FREE**



Perforated Bottom

### GRAY LUG BOX

- ◆ Stackable
- ◆ Polypropylene
- ◆ BPA-free

ITEM	DESCRIPTION	UOM	CASE
PL-8	24" x 15" x 8"	Each	1



PL-8 **BPA FREE**



Stackable for convenient storage

### WHITE MINI BIN

- ◆ Polypropylene
- ◆ BPA-free

ITEM	DESCRIPTION	UOM	CASE
PL-MB	14-3/4" x 12-1/2" x 5-3/8"	Each	24
PL-MBC	Cover	Each	24



PL-MB-SERIES **BPA FREE**

## UTILITY & BUS CARTS



UC-2415G shown with accessory bins

**NEW** UC-2415G



**NEW** UC-SB



**NEW** UC-RB



**NEW** UC-3019K



SUC-30

### UTILITY CARTS

- ◆ 3-tier cart
- ◆ Polypropylene
- ◆ UC-2415 series weighs 17.5 lbs
- ◆ UC-3019 series weighs 27 lbs
- ◆ Accessory bins sold separately
- ◆ Ships knocked down

IMPROVED

ITEM	DESCRIPTION	CAPACITY	COLOR	UOM	CASE
UC-2415G	32"L x 16-1/8"W x 36-3/4"H	330 Lbs	Gray	Set	1
UC-2415K	32"L x 16-1/8"W x 36-3/4"H	330 Lbs	Black	Set	1
UC-3019G	40-3/4"L x 19-1/2"W x 37-3/8"H	400 Lbs	Gray	Set	1
UC-3019K	40-3/4"L x 19-1/2"W x 37-3/8"H	400 Lbs	Black	Set	1
UC-RB	Refuse Bin			Each	3
UC-SB	Silverware Bin			Each	6

Replace former UC-35 Series, UC-40 Series, UC-B Series

### STAINLESS STEEL TROLLEY

- ◆ 3-tier cart
- ◆ Ships knocked down

ITEM	DESCRIPTION	UOM	CASE
SUC-30	30" x 16" x 33" 30" x 16" x 27" (w/o Wheels)	Set	1
SUC-30-C	Caster for SUC-30	Each	4/12
SUC-30-CB	Brake Caster for SUC-30	Each	4/12

## BOX CARTS



**NSF** ABBC-6



**NSF** ALBC-1



### ALUMINUM BUS BOX CART

- ◆ 14 gauge aluminum with a 1" extruded aluminum tube frame
- ◆ 5" Dia x 1-1/4" W, full swivel casters
- ◆ Ships knocked down
- ◆ Capacity: 6 or more (stacked) bus or lug boxes

ITEM	DESCRIPTION	UOM	CASE
ABBC-6	18-5/8" x 26" x 70-1/4"	Set	1
ALRC-5ST	Caster for ABBC-6	Each	12

Compatible WINCO® accessories:  
PL-5G, -5K, -5W, -7G, -7K, -7W bus boxes

### ALUMINUM LUG BOX CART

- ◆ 14 gauge aluminum with a 1" extruded aluminum tube frame
- ◆ 5" Dia x 1-1/4" W, full swivel casters
- ◆ Ships knocked down
- ◆ Compatible with single or stacked lug boxes

ITEM	DESCRIPTION	UOM	CASE
ALBC-1	16-3/4" x 25-1/16" x 19"	Set	1
ALRC-5ST	Caster for ALBC-1	Each	12

Compatible WINCO® accessory: PL-8 lug box

### DELIVERY BAGS

- ◆ Outer shell/liner: polyester, Filling: EPE
- ◆ Heat retention: 2 hours @ 167°F; 4 hours @ 131°F; 6 hours @ 95°F

ITEM	DESCRIPTION	UOM	CASE
BGDV-12	12" x 12" x 12"	Each	6
BGDV-22	22" x 22" x 13"	Each	6

### PIZZA BAGS

- ◆ Outer shell/liner: polyester, Filling: EPE
- ◆ Insulated lining to keep food warm for longer periods of time

ITEM	DESCRIPTION	UOM	CASE
BGPZ-18	18" x 18" x 5"	Each	6
BGPZ-20	20" x 20" x 5"	Each	6
BGPZ-24	24" x 24" x 5"	Each	6

### PIZZA/DELIVERY BAGS



BGDV-SERIES



BGPZ-SERIES

### INSULATED ICE CADDY

- ◆ Can be used inside or outdoors, in hot or humid conditions
- ◆ Drain shelf keeps ice separate from the water, greatly increasing storage time
- ◆ Polyethylene molded body is durable and light-weight, top lid slides open
- ◆ Polyurethane foam insulation effectively keeps ice cold for several days
- ◆ Recessed front handle for convenient pulling or lifting
- ◆ No assembly required; oil caster wheel bearings before use
- ◆ 125 lb capacity
- ◆ NSF listed



### INSULATED ICE CADDY



IIC-29

IIC-SERIES

ITEM	DESCRIPTION	SIZE	UOM	CASE
IIC-29	Ice Caddy w/Sliding Lid	Ext Dim: 23" x 31.5" x 29.25"	Set	1
IIC-C8	Caster for IIC-29	8"	Each	1
IIC-C5B	Brake Caster for IIC-29	5"	Each	1



### INGREDIENT BINS

- ◆ Ideal for mobile storage in the kitchen
- ◆ Advanced super-clasp lid design makes it easy to scoop ingredients without removing the entire cover
- ◆ Clear, plastic front cover makes it simple to identify the ingredients while keeping foods fresh longer
- ◆ 3" caster wheels with brakes make this bin convenient to move from one kitchen work area to another
- ◆ Scoop handle designed to remain out of ingredients and prevent contamination
- ◆ NSF listed

### INGREDIENT BINS



3" Caster Wheels with Brakes



Convenient Scoop Storage



IB-21

ITEM	DESCRIPTION	SIZE	UOM	CASE
IB-21	21 Gallon	13" x 29-1/4" x 28"	Set	1
IB-27	27 Gallon	15-1/2" x 29-1/2" x 28"	Set	1
IB-C3	Caster for IB-21 and IB-27	3"	Each	1
IB-C3B	Caster w/Brake for IB-21 & IB-27		Each	1
IB-21-LE	Lid for IB-21		Each	6
IB-27-LE	Lid for IB-27		Each	6

MODEL	WEIGHT SUGAR	WEIGHT FLOUR
IB-21	159 lbs	124 lbs
IB-27	197 lbs	154 lbs

IB-SERIES



## HOT / COLD FOOD TRANSPORTERS



IFT-1



IFT-2



IFT-1 & IFT-1D



IFT-1D (INCLUDES STRAP)  
Can also be used with IFPC-series



INTERIOR VIEW IFT-1



IFT-SERIES

## FULL-SIZE HOT/COLD FOOD TRANSPORTERS

- ◆ Molded with polypropylene and insulated with polyurethane foam to maintain safe food serving temperatures for hours without the use of electricity or sterno
- ◆ Adjustable vent cap equalizes outside and inside compartment pressure for easy lid opening
- ◆ Stackable and interlockable for easy storage and they're space saving
- ◆ Standard food service pans are easy to load and remove
- ◆ Easy-to-clean holding compartments
- ◆ NSF listed

ITEM	DESCRIPTION	UOM	CASE
IFT-1	Single Insulated Food Pan Cart, NSF	Set	1
IFT-2	Double Insulated Food Pan Cart, Built-In Dolly, NSF	Set	1
IFT-1D	Dolly w/Cargo Strap for IFC-1	Set	1
IFT-C5	5" Caster for IFT-2	Each	1
IFT-C5B	5" Brake Caster for IFT-2	Each	1

HOT		188°F	184°F	179°F	175.5°F	171.5°F
IFT						
IFPC		188°F	184.5°F	181.5°F	179°F	176°F
	Starting Temperature	1 hour	2 hours	3 hours	4 hours	
COLD		33.8°F	34.6°F	35.4°F	36.3°F	37.1°F
IFT						
IFPC		32°F	33°F	34°F	35.5°F	36.5°F
	Starting Temperature	1 hour	2 hours	3 hours	4 hours	

ITEM	DIMENSIONS	COMPARTMENT CAPACITY	
IFT-1	Exterior Dimensions: 18-3/4"W x 26-3/4"D x 24-1/2"H Interior Dimensions: 13-1/4"W x 21"D x 19-5/16"H	6 Full-Size, 2.5" H 4 Full-Size, 4" H 3 Full-Size, 6" H 4 Half-Size, 6" H	8 Half-Size, 4" H 9 1/3 Size, 6" H 12 1/3 Size, 4" H 6 1/3 Size, 8" H
IFT-2	Exterior Dimensions: 20"W x 27-1/2"D x 47-1/4"H Interior Dimensions for Each Compartment: 13-1/4"W x 21"D x 17"H	Each of the two compartments: 4 Full-Size, 2-1/2" H 3 Full-Size, 4" H 2 Full-Size, 6" H 10 Half-Size, 2-1/2" H	Can hold the following pans: 6 Half-Size, 4" H 4 Half-Size 6" H 6 1/3rd Size, 6" H 9 1/3rd Size, 4" H
IFT-1D		Use with IFT-1	

## COMPACT HOT/COLD FOOD TRANSPORTERS

- ◆ Compact carriers offer the perfect solution for transporting hot or cold foods
- ◆ NSF listed

ITEM	DESCRIPTION	UOM	CASE
IFPC-4	Up to 4" H Food Pans	Set	1
IFPC-6	Up to 6" H Food Pans	Set	1
IFPC-8	Up to 8" H Food Pans	Set	1

Spare parts available for sale

ITEM	DIMENSIONS	COMPARTMENT CAPACITY
IFPC-4	Exterior Dimensions 24-3/4"L x 17-1/4"W x 8-1/4"H Interior Height: 4"	Holds 4" H Pans, 1 Full-Size / 2 Half-Size / 3 Third-Size
IFPC-6	Exterior Dimensions 24-3/4"L x 17-1/4"W x 10-1/4"H Interior Height: 6"	Holds 6" H Pans, 1 Full-Size / 2 Half-Size / 3 Third-Size
IFPC-8	Exterior Dimensions 24-3/4"L x 17-1/4"W x 12"H Interior Height: 8"	Holds 8" H Pans, 1 Full-Size / 2 Half-Size / 3 Third-Size



IFPC-4



IFPC-6



IFPC-8

Adjustable vent cap on full-size & compact transporters



IFPC-6 Stackable view



IFPC-SERIES

# *Snack & Refreshment*

## **EQUIPMENT** *Cook & Merchandise*



# HEATED DISPLAY MERCHANDISERS

AVAILABLE IN JULY 2017

NEW



HDM-13  
13.6"L X 19"W X 26"H



Control Panel

## COUNTERTOP HEATED DISPLAY MERCHANDISERS

- ◆ Removable water pan to add and control humidity
- ◆ Three (3) adjustable shelves inside, top can also be used as a shelf
- ◆ Lighted front display for branding visuals
- ◆ Visible thermometer gauge to ensure food keeps at proper temperatures
- ◆ Adjustable thermostat from 85°F to 195°F (30°C to 90°C)
- ◆ Customer-facing front service and rear access doors
- ◆ 26" high
- ◆ One year warranty

ITEM	DESCRIPTION	UOM	CASE
HDM-13	850W, 7.1A, 13-1/2"L	Set	1
HDM-26	1050W, 8.8A, 26-1/2"L	Set	1
HDM-36	1200W, 10.0A, 36"L	Set	1
HDM-48	1650W, 13.75A, 48"L	Set	1



HDM-26  
26.6"L X 19"W X 26"H



HDM-36  
36"L X 19"W X 26"H



HDM-48  
48"L X 19"W X 26"H

## SOUP MERCHANDISERS

The Soup Merchandiser is the perfect solution for salad bars and sandwich shops. With an attractive artwork display that is both functional and inviting, it includes soup insets, covers, adaptor plates and ladles. Units are available in two 7 quart insets or three 4 quart insets.

DESCRIPTION	SIZE	WEIGHT	VOLTAGE	HZ	WATTAGE
Soup Merchandiser Warmer, (base for all models)	22-3/8"L x 14-9/16"W x 9 1/2"H Well inner depth: 6"	38 lbs.	120V	50/60	1200*

One (1) dedicated 20 Amp circuit with single outlet is required for the unit.



ESM-27HNB



ESM-34KNB

MODEL	STYLE	Items included in Package	ADAPTOR PLATE		INSET		COVER		LADLE
			ADP-808 (Fits 2: 7 qt.)	ADP-666 (Fits 3: 4 qt.)	INS-7.0M (7 qt.)	INS-4.0 (4 qt.)	INSH-7 (hinged)	INSC-4 (slotted)	LDC-4 (4 oz.)
ESM-27HNB	Hot & Hearty		X		2		2		2
ESM-34HNB	Hot & Hearty			X		3		3	3
ESM-27KNB	Kettle Fresh		X		2		2		2
ESM-34KNB	Kettle Fresh			X		3		3	3

Custom graphics available! Email sales@wincous.com for more information.

Built to order, extra three (3) day lead time required.

DISPLAY MERCHANDISERS

**ELECTRIC HEATED PIZZA MERCHANDISER**

Digital control of both temperature and humidity.

- ◆ Forced air for convection heating
- ◆ Active humidity with water fill-tray
- ◆ Display tray insert rotates when door is closed
- ◆ Accommodates four (4) full-size 18" pizzas
- ◆ Dimensions: 25-1/2"L x 23-3/4"W x 27-3/4"H
- ◆ One year warranty



ITEM	DESCRIPTION	UOM	CASE
EDM-1	1800W, 15A	Set	1



EDM-1



**ELECTRIC HEATED PIZZA/PRETZEL MERCHANDISERS**

Passive humidity control with removable water tray.

- ◆ Interior wire shelves hold four (4) 14" pizzas
- ◆ Optional pretzel rack insert, sold separately
- ◆ Display tray/rack insert rotates when door is closed
- ◆ Lighted display panel for branding visuals
- ◆ Removable crumb tray
- ◆ Dimensions: 18"L x 17-1/5"W x 31"H
- ◆ One year warranty



ITEM	DESCRIPTION	UOM	CASE
EDM-2	875W, 15A	Set	1
EDM-2PR	Optional Pretzel Rack Insert	Set	1
EDM-2PRS	Pretzel Sign, 5-3/4"H x 16-1/8"W	Each	1
EDM-2PZS	Pizza Sign, 5-3/4"H x 16-1/8"W	Each	1



EDM-2



EDM-2PRS



EDM-2PZS

Translucent Plastic Display Signs Available for EDM-2, Sold Separately



EDM-2PR  
Optional Pretzel Rack

ELECTRIC COFFEE WARMERS

ELECTRIC COFFEE WARMERS

Keep coffee fresh, hot and ready to serve at the optimal serving temperature. Coffee warmers are ideal for any self-service area.

- ◆ Low-profile for maximum product visibility and countertop space conservation
- ◆ Durable stainless steel body with ceramic-coated plates
- ◆ Separate lighted on/off switches for convenient operation
- ◆ 120V~60Hz, 100W per burner
- ◆ ETL listed for safety and sanitation

NEW SIZE  
ECW-2S



ITEM	DESCRIPTION	UOM	CASE
ECW-1	Single Burner, 100W	Each	6
ECW-2	Double Burners, 200W	Each	6
ECW-2S	Step-Up Double Burner, 200W	Each	1

ETL Intertek  
ECW-SERIES



ECW-1



ECW-2

REFRIGERATED COLD BEVERAGE DISPLAY

COUNTERTOP REFRIGERATED BEVERAGE DISPLAYS

With its clear panels and 4 LED light strips, this countertop display can keep up to 100 standard 12 oz cans chilled.

- ◆ Digital temperature control from 34°F to 44°F
- ◆ 360° view of refrigerated product
- ◆ 2 double-glass doors for versatile placement and easy access
- ◆ 4 LED strips for effective product lighting
- ◆ Comfortably fits up to 100 cans (standard 12 oz) with 25 cans per shelf
- ◆ Adjustable shelf height to fit multiple product sizes
- ◆ Durable triple-layered PVC-coated shelves
- ◆ Automatic defrost and ventilated cooling system
- ◆ Dimensions: 17"L x 17"W x 39"H
- ◆ 120V~60Hz, 230W, 1.4A
- ◆ One year warranty

AVAILABLE IN JUNE 2017

LED LIGHTED



CRD-1

ITEM	DESCRIPTION	UOM	CASE
CRD-1	White	Set	1
CRD-1K	Black	Set	1

NEW COLOR  
CRD-1K



ETL Intertek  
CRD-SERIES



Comfortably fits 100 cans



CONFECTIONARY MACHINES



**ELECTRIC COTTON CANDY MACHINE**

- ◆ Simple, easy-to-use controls
- ◆ Includes sugar scooper for pouring floss sugar
- ◆ 20-1/2" diameter bowl is stainless steel
- ◆ Spinner head accommodates 4 oz. of floss sugar
- ◆ Easy access to voltage meter and fuse for use on generators and power supplies
- ◆ Optional clear lid (sold separately) provides protection from wind and debris
  
- ◆ Base unit dimensions: 20-1/2"L x 20-1/2"W x 19"H
- ◆ 120V~60Hz, 1080W, 9A
- ◆ Cover only: 21"L x 21"W x 14"H
  
- ◆ One year warranty

ITEM	DESCRIPTION	UOM	CASE
CCM-28	1080W, 9A	Set	1
CCM-28C	Clear Plastic Dome Cover	Each	5



CCM-28

**POPCORN POPPERS**

- ◆ 8 oz stainless steel kettle is removable; POP-8R includes non-stick kettle
- ◆ Built-in warmer light
- ◆ Removable crumb tray
- ◆ Tempered glass side panels
- ◆ Clear plexiglass doors and stainless steel fold-out tray for easy access
  
- ◆ POP-8B: 15-3/4"L x 14-3/4"W x 23"H / 120V~60Hz, 1130W, 9.5A
- ◆ POP-8R: 22"L x 16-1/2"W x 30"H / 120V~60Hz, 1350W, 12A
  
- ◆ One year warranty

ITEM	DESCRIPTION	UOM	CASE
POP-8B	Black, 1130W	Set	1
POP-8R	Red w/Teflon® Coated Non-Stick Kettle, 1350W	Set	1



POP-8R



POP-8B

## ELECTRIC FOOD COOKER/WARMER, 1500W



FW-S600

## ELECTRIC FOOD COOKER/WARMER, 1500W

*With a unique design that not only meets but exceeds standard NSF-4 rethermalization testing requirements, the FSW-S600 is a multitasking cooker plus warmer that maintains temperatures for extended periods of time.*

- ◆ Energy-efficient insulated heating compartment for maximum efficiency
- ◆ Indicator light for monitoring status
- ◆ Easy control settings that cook and keep food at the right temperature all day
- ◆ Stainless steel body with vented sides
- ◆ 20" x 12" standard opening that holds full-size pans with depths of up to 6"
- ◆ 3 settings: Low = 140°F, Medium = 170°F, High = 200°F
- ◆ ETL listed for electrical safety, conforms to UL-197
- ◆ ETL listed for sanitation, conforms to NSF-4
- ◆ Overall dimensions: 22-1/2"L x 14-5/8"W x 10-5/8"H
- ◆ Inside dimensions: 20"L x 12"W x 6"H
- ◆ 120V~60Hz, 1500W
- ◆ One year warranty

ITEM	DESCRIPTION	UOM	CASE
FW-S600	Cooker/Warmer	Set	1

## ELECTRIC FOOD WARMER, 1200W



FW-S500

## ELECTRIC FOOD WARMER, 1200W

*With highly efficient heating distribution, Winco's food warmer is a workhorse that can endure the harshest kitchen environments.*

- ◆ Energy-efficient design for faster heating and lower utility costs
- ◆ Heavy-duty stainless steel body for commercial use
- ◆ Standard opening - 20" x 12" - fits most full-size pans with depths of up to 6"
- ◆ 3 settings: Low = 140°F, Medium = 170°F, High = 200°F
- ◆ ETL listed for electrical safety, conforms to UL-197
- ◆ ETL listed for sanitation, conforms to NSF-4
- ◆ Overall Dimensions: 22-1/2" L x 14-5/8" W x 9-3/8" H
- ◆ Inside Dimensions: 20" L x 12" W x 6" H
- ◆ 120V~60Hz, 1200W
- ◆ One year warranty

ITEM	DESCRIPTION	UOM	CASE
FW-S500	Warmer	Set	1

**COMMERCIAL ELECTRIC INDUCTION COOKER**

Safer than traditional gas or electric resistance burners, induction cooktops use magnetism to rapidly heat up induction cookware, which in turn heats up food. The ideal choice for tableside, catering and buffet line cooking, induction cooktops are faster and more efficient than installed gas stovetops.

- ◆ Digitally controlled wattage and temperature
- ◆ 11" x 11" German SCHOTT™ ceramic glass surface
- ◆ Up to 1800 watts of continuous heat
- ◆ Adjustable heat from 120°F to 460°F (50°C to 240°C)
- ◆ Durable stainless steel body construction
- ◆ Timer up to 150 min (2-1/2 hours)
- ◆ Adjustable foot for added stability
- ◆ Auto safety shut off at 2-1/2 hours
- ◆ ETL and NSF listed for commercial use in US and Canada
- ◆ Dimensions: 16-1/2"L x 13"W x 4"H
- ◆ 120V~60 Hz
- ◆ One year warranty

ITEM	DESCRIPTION	UOM	CASE
EIC-400	1800W, 15A	Each	2

**COMMERCIAL ELECTRIC INDUCTION COOKER**



EIC-SERIES





**PORTABLE BUTANE STOVE**

This portable and compact butane stove is great for camping, outdoor parties or catered events.

- ◆ Single solid brass burner, built-in pot support and wide base for stability
- ◆ Manually adjustable heat range with up to 9,500 BTU of power
- ◆ Comes with a black impact-resistant hard plastic carrying case for easy transport
- ◆ Automatic gas shut-off safety feature
- ◆ Uses standard 8 oz Butane DOT-2P canister (sold separately)
- ◆ CSA listed for commercial and outdoor use

ITEM	DESCRIPTION	UOM	CASE
PGS-1K	Portable Gas Cooker, Black, 9500 BTUs, Brass Burner w/Case	Each	6

**BUTANE STOVE**



Fits standard Butane canister

PGS-1K





**ELECTRIC WATER PAN**

- ◆ Stands alone or fits standard full-size chafer frames for an electric alternative
- ◆ Can accommodate full-size steam table pans
- ◆ Adjustable temperature
- ◆ Food pan sold separately
- ◆ Dimensions: 22-5/8"L x 13-5/8"W x 7"H
- ◆ 120V~60Hz, 900W, 7.5A
- ◆ One year warranty

ITEM	DESCRIPTION	UOM	CASE
EWP-2	Full-Size	Each	1

**ELECTRIC WATER PAN**



Fits inside standard full-size chafer

EWP-2



## PROFESSIONAL ELECTRIC FREESTANDING HEAT LAMP



EHL-2

INCLUDES 2 CLEAR, INFRARED 250W/120V BULBS



## PROFESSIONAL ELECTRIC FREESTANDING HEAT LAMP

Keep prepared food warm and appetizing at ideal serving temperatures under the twin-bulb infrared heat lamp, featuring maximum adjustability and improved stability on countertop surfaces.

- ◆ Extra heavy-duty 14 gauge aluminum frame with 1-1/8" jumbo square tube
- ◆ Includes two (2) shatter-resistant, clear, infrared 250W/120V bulbs
- ◆ Light-weight all-aluminum design
- ◆ 4-position adjustable height
- ◆ 6 foot power cord
- ◆ ETL listed for electrical safety in US and Canada, conforms to UL-197 and CSA C22.2
- ◆ ETL listed for sanitation, conforms to NSF-4
- ◆ Dimensions: 19-1/2"L x 14-1/4"W x 23-1/2"H
- ◆ Base: 16-1/4"L x 14-1/4"W
- ◆ 120V~60Hz
- ◆ One year warranty

ITEM	DESCRIPTION	UOM	CASE
EHL-2	4-Position Heat Lamp	Set	1
EHL-BR	Replacement Bulb for EHL-2, Red	Each	12
EHL-BW	Replacement Bulb for EHL-2, Clear	Each	12

## ELECTRIC HEAT LAMP



EHL-2C

INCLUDES 2 CLEAR, INFRARED 250W/120V BULBS



## ELECTRIC HEAT LAMP

Maintain ideal serving temperatures to keep prepared food warm and appetizing under this infrared twin-bulb heat lamp, featuring maximum adjustability, improved countertop stability and an easy-to-clean, scratch-resistant finish.

- ◆ Keeps plated foods at optimal serving temperatures
- ◆ Heavy-duty steel tubing
- ◆ Easy-to-clean, durable scratch-resistant electrostatic powder coated finish on hoods and frame
- ◆ 3-position adjustable height for controlling heat intensity
- ◆ Compatible with most standard-size food trays
- ◆ Includes two (2) shatter-resistant, clear, infrared 250W/120V bulbs
- ◆ 6 foot power cord
- ◆ ETL listed for electrical safety in US and Canada, conforms to UL-197 and CSA C22.2
- ◆ ETL listed for sanitation, conforms to NSF-4
- ◆ Height: adjustable to 24", 26.5", or 29"
- ◆ Base: 18"L x 14"W
- ◆ 120V~60 Hz
- ◆ One year warranty

ITEM	DESCRIPTION	UOM	CASE
EHL-2C	3-Position Heat Lamp	Set	1

**ELECTRIC STRIP HEATER**

- ◆ Includes undermount bracket and bolt set (ESH-UB) for optional mounting under shelves
- ◆ Extruded aluminum body for durability and cleanliness
- ◆ Tubular sheath heating element provides constant and reliable infrared heating
- ◆ Stand adjusts to three height positions: 17-1/2"H, 20"H, and 22-1/2"H
- ◆ Dimensions w/base: 25-1/2"L x 14"W x various heights
- ◆ Without base: 24"L x 6"W x 2-1/2"H
- ◆ 120V~60Hz, 500W, 4.2A
- ◆ One year warranty

ITEM	DESCRIPTION	UOM	CASE
ESH-1	Electric Strip Heater	Set	1

**ELECTRIC STRIP HEATER**



ESH-1



*Countertop fryers are a great, easy addition to any food service operation. Great for chicken, fries, onion rings, tempura, shrimp, vegetables and more!*

- ◆ Commercial fry basket(s) with safe secure handle
- ◆ Expedient heat-up
- ◆ Removable stainless steel fry well(s) for easy cleaning
- ◆ Removable power head(s)
- ◆ Fry well cover(s) included
- ◆ ETL listed for electrical safety in US and Canada, conforms to UL-197 and CSA C22.2
- ◆ ETL listed for sanitation, conforms to NSF-4
- ◆ One year warranty

**ELECTRIC COUNTERTOP DEEP FRYERS**



Cover(s) for well(s) are included



EFS-16

**ELECTRIC COUNTERTOP SINGLE WELL DEEP FRYER**

- ◆ 16 lb oil capacity
- ◆ 8 liters = 16 lbs = 2.3 gallons
- ◆ Overall dimensions: 11-3/4"L x 16"W x 13-5/8"H
- ◆ 120V~60Hz, 1750W, 15A

ITEM	DESCRIPTION	UOM	CASE
EFS-16	Single Well	Set	1

**ELECTRIC COUNTERTOP TWIN WELL DEEP FRYER**

- ◆ 32 lb oil capacity
- ◆ 2 x 8 liters (16 liters combined) = 32 lbs; total = 4.8 gallons
- ◆ Overall dimensions: 21-1/4"L x 16"W x 13-5/8"H
- ◆ 120V~60Hz, 2 x 1750W, 2 x 15A

ITEM	DESCRIPTION	UOM	CASE
EFT-32	Double Well	Set	1



EFT-32



## ELECTRIC COUNTERTOP SANDWICH GRILLS



ESG-1



ESG-2



ESG-SERIES



## COUNTERTOP SANDWICH GRILLS

*Flat-top grills are great for not only sandwiches, but are widely used for breakfast eggs and meats, flat breads, quesadillas and more!*

- ◆ Flat cast iron grill surface
- ◆ Hinged balanced top plate adjusts to food thickness
- ◆ Removable crumb and grease tray
- ◆ Power and ready light(s)
- ◆ Stainless steel construction
- ◆ Adjustable thermostat(s) up to 600°F
- ◆ ETL listed for electrical safety in US and Canada, conforms to UL-197 and CSA C22.2
- ◆ ETL listed for sanitation, conforms to NSF-4
- ◆ One year warranty

### SINGLE SANDWICH GRILL

- ◆ Grill surface: 14" x 9"
- ◆ Overall dimensions: 17"L x 12"W x 8"H
- ◆ 120V~60Hz, 1750W, 15A

ITEM	DESCRIPTION	UOM	CASE
ESG-1	Single Grill	Set	1

### DOUBLE SANDWICH GRILL

- ◆ Grill surface: 19" x 9"
- ◆ Overall dimensions: 22-1/2"L x 12"W x 8"H
- ◆ 120V~60Hz, 2 x 1750W, 2 x 15A

ITEM	DESCRIPTION	UOM	CASE
ESG-2	Double Grill	Set	1

## ELECTRIC COUNTERTOP PANINI GRILLS



EPG-1



EPG-2



EPG-SERIES



## COUNTERTOP PANINI GRILLS

*This versatile grill can be used in every type of food service operation for paninis, sandwiches, wraps, grilled vegetables, chicken or hamburgers.*

- ◆ Ribbed cast iron grill surface
- ◆ Hinged balanced top plate adjusts to food thickness
- ◆ Removable crumb and grease tray
- ◆ Power and ready light(s)
- ◆ Stainless steel construction
- ◆ Adjustable thermostat(s) to 600°F
- ◆ ETL listed for electrical safety in US and Canada, conforms to UL-197 and CSA C22.2
- ◆ ETL listed for sanitation, conforms to NSF-4
- ◆ One year warranty

### SINGLE PANINI GRILL

- ◆ Grill surface: 14" x 9"
- ◆ Overall dimensions: 17"L x 12"W x 8"H
- ◆ 120V~60Hz, 1750W, 15A

ITEM	DESCRIPTION	UOM	CASE
EPG-1	Single Grill	Set	1

### DOUBLE PANINI GRILL

- ◆ Grill surface: 19" x 9"
- ◆ Overall dimensions: 22-1/2"L x 12"W x 8"H
- ◆ 120V~60Hz, 2 x 1750W, 2 x 15A

ITEM	DESCRIPTION	UOM	CASE
EPG-2	Double Grill	Set	1

**ELECTRIC COUNTERTOP CONVECTION OVENS**

- ◆ Stainless steel construction
- ◆ Built-in 120 minute timer with "Stay On" feature
- ◆ Dual pane tempered glass door
- ◆ Spacious interior includes three chrome wire shelves
- ◆ Whisper quiet circulation
  
- ◆ ECO-250: 120V~60Hz, 1440W, 12A
- ◆ Overall Dimensions: 18-3/4"L x 19-7/8"W x 15"H
  
- ◆ ECO-500: 120V~60Hz, 1600W, 13.3A
- ◆ Overall Dimensions: 22-1/2"L x 22-3/4"W x 17-3/4"H
  
- ◆ One year warranty

ITEM	DESCRIPTION	UOM	CASE
ECO-250	Quarter-Size, 0.8 Cubic Ft	Set	1
ECO-500	Half-Size, 1.5 Cubic Ft	Set	1



Spacious interior

**ELECTRIC COUNTERTOP CONVECTION OVENS**



ECO-250



ECO-500



**ELECTRIC COUNTERTOP PIZZA OVEN**

- ◆ Dual independently controlled heating elements
- ◆ 60 minute timer with bell includes "Stay On" feature
- ◆ Pizza tray handle folds for storage
- ◆ Includes crumb tray
  
- ◆ Designed to easily fit up to a 12" diameter pizza
- ◆ Dimensions: 20-7/8"L x 14-3/4"W x 9-1/4"H
- ◆ 120V~60Hz, 1500W, 12.5A
  
- ◆ One year warranty

ITEM	DESCRIPTION	UOM	CASE
EPO-1	700°F w/Bell Timer and "Stay On" Function, 1500W	Set	1

**ELECTRIC PIZZA OVEN**



Easily fits 12" pizza



EPO-1

ELECTRIC RICE COOKERS

AVAILABLE IN MAY 2017

NEW



NSF SR-GA421H

UL US LISTED



RC-P300

ETL Intertek RC-SERIES



RC-S300

ETL Intertek RC-SERIES

PANASONIC 23-CUP COMMERCIAL ELECTRIC RICE COOKER

- ◆ Stainless steel lid with glass window
- ◆ Aluminum alloy inner pot is removable
- ◆ Built-in thermal safety fuse
- ◆ Automatic shut-off
- ◆ Keeps contents warm up to 5 hours
- ◆ Conforms to UL-197 and CSA C22.2
- ◆ NSF listed
- ◆ Dimensions: 16-7/8"L x 14-7/8"W x 11-7/8"H
- ◆ 120V~60Hz, 1550W, 12.9A
- ◆ One year warranty

ITEM	DESCRIPTION	UOM	CASE
SR-GA421H	23-Cup Capacity	Each	1
<i>Replaces former SR-42H2P-D</i>			

ELECTRIC RICE COOKER

Assembled with premium electrical parts from Korea and Japan, Winco's electric rice cooker makes up to 60 cups of delicious rice.

- ◆ Holds up to 30 cups of uncooked rice
- ◆ Inner pot seals in moisture
- ◆ Includes cover, inner pot, measuring cup and serving paddle
- ◆ ETL listed for electrical safety, conforms to UL-197 and UL-1026
- ◆ ETL listed for sanitation, conforms NSF-4
- ◆ Dimensions: 15-11/16"L x 15-11/16"W x 12-3/8"H
- ◆ 120V~60Hz, 1550W
- ◆ One year warranty

ITEM	DESCRIPTION	UOM	CASE
RC-P300	Rice Cooker	Set	1
RC-P300P	Inner pot for RC-P300P	Each	1
RC-F	Fuse for RC-S300 & RC-P300 Can be used in most commercial rice cookers	Each	50

ADVANCED ELECTRIC RICE COOKER/WARMER WITH HINGED COVER

Both a cooker and warmer, the Advanced Electric Rice Cooker from Winco is designed to keep rice at the ideal serving temperature and texture.

- ◆ Holds 30 cups of uncooked rice or 60 cups of cooked rice
- ◆ Fingerprint-proof satin finish on heavy-duty stainless steel body
- ◆ Non-stick inner pot seals in moisture
- ◆ Energy efficient heat absorption system
- ◆ Automatically keeps rice warm for up to 6 hours
- ◆ Major electrical parts made in Korea/Japan
- ◆ Includes inner pot, measuring cup and serving paddle
- ◆ ETL listed for electrical safety, conforms to UL-197 and UL-1026
- ◆ ETL listed for sanitation, conforms to NSF-4
- ◆ Dimensions: 17-1/2"L x 17-1/2"W x 15"H
- ◆ 120V~60Hz, 1550W
- ◆ One year warranty

ITEM	DESCRIPTION	UOM	CASE
RC-S300	Hinged-Cover Rice Cooker/ Warmer	Set	1
RC-S300PN	Inner pot for RC-S300	Each	1
RC-F	Fuse for RC-S300 & RC-P300 Can be used in most commercial rice cookers	Each	50





**ELECTRIC RICE WARMER**

Premium electrical parts are the foundation for the consistent quality and dependability of this 100-cup electric rice warmer from Winco.

- ◆ Holds 100 cups of uncooked rice
- ◆ Fingerprint-proof satin finish on heavy-duty stainless steel body
- ◆ Non-stick inner pot seals in moisture
- ◆ Energy efficient heat absorption system
- ◆ Keeps contents warm for up to 24 hours
- ◆ Major electrical parts made in Korea/Japan
- ◆ ETL listed for electrical safety, conforms to UL-197 and UL-1026
- ◆ ETL listed for sanitation, conforms to NSF-4
- ◆ Dimensions: 16-13/16"L x 16-13/16"W x 17-1/2"H
- ◆ 120V~60Hz, 84W
- ◆ One year warranty



ITEM	DESCRIPTION	UOM	CASE
RW-S450	100 Cup Electric Rice Warmer	Set	1
RW-450P	Inner pot for RW-S450	Each	1
RW-F	Fuse for RW-S450 Can be used in most commercial rice warmers	Each	48/192

**ELECTRIC RICE WARMER**



RW-S450



This extra large kettle-style soup warmer keeps contents at safe serving temperatures for hours on end, great for serving all day.

- ◆ 10-quart capacity for warming and holding soup
- ◆ Adjustable heat control keeps contents at a safe serving temperature without over-cooking
- ◆ Stainless steel hinged no-drip lid allows cover to be opened and reclosed during service
- ◆ Includes removable 18/8 stainless steel bain marie inner pot
- ◆ Outer surface stays cool to the touch thanks to double-wall construction
- ◆ Infinite thermostatic control
- ◆ ETL listed for electrical safety in U.S.A. and Canada, conforms to UL-197 and CSA C22.2
- ◆ ETL listed for sanitation, conforms to NSF-4
- ◆ Dimensions: 13-3/16"L x 13-3/16"W x 15"H
- ◆ 120V~60Hz, 400W
- ◆ One year warranty

**ELECTRIC SOUP WARMERS**



ESW-70



ESW-66

**ELECTRIC STAINLESS STEEL SOUP WARMER**

- ◆ Includes suction label holder and variety of pre-printed soup names

ITEM	DESCRIPTION	UOM	CASE
ESW-70	Soup Warmer Set	Set	1

**ELECTRIC SOUP WARMER**

- ◆ Infinite thermostatic control
- ◆ Includes magnetic label holder and a variety of pre-printed soup names

ITEM	DESCRIPTION	UOM	CASE
ESW-66	Soup Warmer Set, 3 Amps	Set	1
ESW-INS	Insert Pot for ESW-66 and ESW-70, No Retail Pkg	Each	2



ESW-SERIES



ACCELMIX™ BLENDER

**ACCELMIX™**  
by Winco®

ADD POWER & PERFORMANCE TO YOUR BAR

NEW



**ACCELMIX™ ELECTRIC COUNTERTOP BLENDER**

- ◆ High-performance motor with impact-resistant stainless steel blades
- ◆ Extra large 68 oz capacity, break-resistant Tritan™ container is BPA-free
- ◆ Simple "PULSE" and "ON/OFF" paddle controls and variable speed control dial
- ◆ Removable container cover and cap for adding ingredients mid-cycle, as well as for pressure reduction when blending hot foods
- ◆ Commercial-grade quality
- ◆ Container/pitcher is heat-resistant up to 226°F (108°C)
- ◆ Includes an 11-1/2" tamper to fit fully inside container and blend/stir up solid foods through the lid
- ◆ All parts except base are dishwasher safe
- ◆ ETL listed for electrical safety in US and Canada, conforms to UL-197 and CSA C22.2
- ◆ Overall dimensions: 9"L x 10"W x 20"H
- ◆ Container dimensions: 11-1/2"H x 6-5/8"W x 6-1/4"D
- ◆ 120V~60Hz, 1450W
- ◆ One year warranty

ITEM	DESCRIPTION	UOM	CASE
XLB-1000	Electric Blender with Paddle Controls	Set	4

ETL US Intertek XLB-1000

BPA FREE TRITAN™ CONTAINER



Cap removed and tamper inserted



Blend fruits, ice and a variety of other ingredients



# SPECTRUM

COUNTERTOP EQUIPMENT



**FOR THE GROWING  
ESTABLISHMENT**

By **Winco**<sup>®</sup>

COMMERCIAL STAINLESS STEEL  
**TOUCH CONTROL  
 MICROWAVE**



EMW-1000ST

MODEL	VOLTAGE	INPUT POWER (W)	OUTPUT POWER (W)	AMPS	OVEN CAPACITY	DIMENSIONS (INCHES)			LBS
						WIDTH	DEPTH	HEIGHT	
EMW-1000ST	120 V	1450 W	1000 W	12	0.9 Ft <sup>3</sup>	20.1"	17"	12.2"	32.19



A durable, attractive full **stainless steel exterior and interior** construction highlights the powerful and efficient **SPECTRUM TOUCH CONTROL MICROWAVE**. Offering 1000W of microwave power, this microwave is ideal for heating and warming grab-and-go items, soups, sandwiches, prepackaged lunches, beverages, and more at your concession stand, lunch room, snack bar, office, or quick-serve establishment. Built with the commercial user in mind, this unit accommodates 10 easy-to-program functions including defrost, and will withstand repeated use in a professional, high-volume environment. The unique motor-driven bottom antenna provides efficient energy distribution, peak performance, and consistent results to keep your establishment moving with ease. With multiple power levels and adjustable time intervals, as well as a spacious 0.9 cubic feet oven cavity, this microwave is flexible enough to accommodate a variety of items to meet all your cooking and warming needs.

- ◆ 1,000 watts of cooking power for quick heating
- ◆ Motor driven bottom antenna for efficient energy distribution and consistent results
- ◆ Engineered for commercial kitchen use
- ◆ Stainless steel interior with bottom ceramic plate
- ◆ Ample 0.9 cubic feet (25 L) oven capacity
- ◆ Accommodates 12" (30.5 cm) diameter platter
- ◆ Backlit LED display
- ◆ Interior oven light
- ◆ 3 customizable key beep volume levels
- ◆ Overall dimensions: 20.1"W x 17"D x 12.2"H
- ◆ One year warranty

ITEM	DESCRIPTION	UOM
EMW-1000ST	Spectrum Commercial Microwave, Touch, Stainless Steel, 1,000 W	Set

# COMMERCIAL STAINLESS STEEL DIAL CONTROL MICROWAVE



EMW-1000SD

MODEL	VOLTAGE	INPUT POWER (W)	OUTPUT POWER (W)	AMPS	OVEN CAPACITY	DIMENSIONS (INCHES)			LBS
						WIDTH	DEPTH	HEIGHT	
EMW-1000SD	120 V	1450 W	1000 W	12	0.9 Ft <sup>3</sup>	20.5"	17.9"	12.3"	42.55



Built with convenience, speed, operability, and durability in mind, the **SPECTRUM DIAL CONTROL MICROWAVE** provides quick heating capabilities via 1000W of microwave power, making it ideal for warming soups, sandwiches, prepackaged lunches, beverages, and more. Engineered for commercial kitchen use, this microwave features an all **stainless steel exterior and interior**, compared to competitors' painted interior units. Additionally the ceramic heating plate features a bottom energy feed system, allowing for peak performance, efficient energy distribution, and consistent results. With multiple power levels and adjustable time intervals, as well as a spacious 0.9 cubic feet oven cavity, this microwave is flexible enough to accommodate a variety of items to meet all your cooking and warming needs.

- ◆ 1,000 watts of cooking power for quick heating
- ◆ Motor driven bottom antenna for efficient energy distribution and consistent results
- ◆ Engineered for commercial kitchen use
- ◆ Stainless steel interior with bottom ceramic plate
- ◆ Ample 0.9 cubic feet (25 L) oven capacity
- ◆ Accommodates 12" (30.5 cm) diameter platter
- ◆ Customizable cooking timer up to 60 minutes
- ◆ Backlit LED display
- ◆ Interior oven light
- ◆ Overall dimensions: 20.5"W x 17.9"D x 12.3"H
- ◆ One year warranty

ITEM	DESCRIPTION	UOM
EMW-1000SD	Spectrum Commercial Microwave, Dial, Stainless Steel, 1,000 W	Set



DOUBLE WALL • STAINLESS STEEL

# COFFEE URN



CU-72

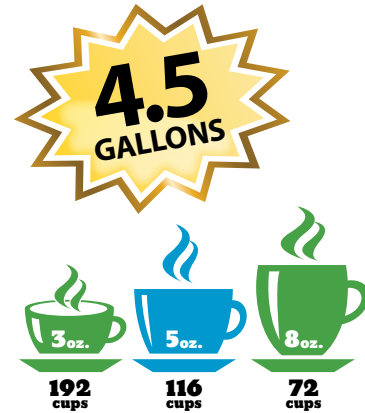

MODEL	8 OZ. CUPS / MINUTE	VOLTAGE	POWER (W)	AMPS	DIMENSIONS (INCHES)			LBS
					WIDTH	DEPTH	HEIGHT	
CU-72	1.5	120 V	1620 W	13.5 A	14.5"	14"	22.5"	9.86



Bring quality coffee to your next catered event with the **SPECTRUM COFFEE URN**. This 4.5 gallon percolating coffee urn consistently brews delicious, flavorful coffee day in and day out, and recycles automatically between brewing and holding modes to maintain the coffee at the ideal serving temperature. Featuring a durable, double-wall insulated stainless steel construction and plastic heat-resistant handles that keep the unit cool-to-the touch, this coffee urn brews up to 72 8 oz. cups within minutes to keep customers happy and perked up at your next event.

- ◆ Brews coffee and recycles automatically to maintain ideal serving temperature
- ◆ Durable double-wall insulation keeps body cool to the touch
- ◆ Plastic cool-touch handles and spout for easy handling
- ◆ Warming light to show unit is in warming/holding mode
- ◆ Sight gauge indicates level of remaining contents
- ◆ Automatic safety shut-off to prevent overheating
- ◆ Ideal for caterers, restaurants, schools, offices, hospitals, nursing homes, shops or open houses for example
- ◆ ETL listed for safety and sanitation
- ◆ One year warranty

ITEM	DESCRIPTION	UOM
CU-72	Stainless Steel Double-Wall Coffee Urn, Set 72 Cups (4.5 Gallons)	

# ELECTRIC COUNTERTOP CONVEYOR TOASTER



ECT-500 back view

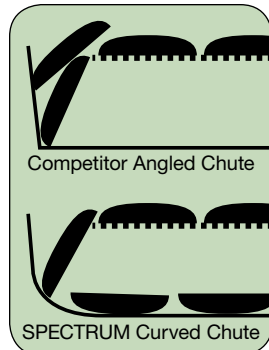

The curved return chute prevents larger food items from getting caught up.



ECT-500

MODEL	SLICES PER HOUR	VOLTAGE	POWER (W)	AMPS	DIMENSIONS (INCHES)			LBS
					WIDTH	DEPTH	HEIGHT	
ECT-500	500	208/240 V	2000/2600	9.6/10.8	14.6"	17"	15"	39.57

Dimensions do not include accessory pieces.



The **SPECTRUM CONVEYOR TOASTER** is perfect for high volume serving of bagels, toast, small pizzas and similar dough based products that need fast and consistent toasting. The conveyor toaster is easy to operate and the belt speed setting control allows for perfect doneness. The Spectrum Conveyor Toaster can utilize top and bottom heating elements simultaneously or independently. The specially designed product return ramp is extra wide for toasting oversized bagels. The conveyor toaster has front product return as well as optional rear product return. The Spectrum Conveyor Toaster is NSF, CUL and UL approved.

- ◆ Toaster makes up to 500 slices per hour
- ◆ Rounded return chute allows for extra-large bagels
- ◆ Infinite speed doneness control
- ◆ Independent 3-position heating element selector
- ◆ Multiple power and speed ("Doneness") settings to get the perfect toast
- ◆ Adjustable feet
- ◆ UL listed for compliance with UL-197
- ◆ NSF listed for compliance with NSF-4
- ◆ One year warranty

ITEM	DESCRIPTION	UOM
ECT-500	Electric Conveyor Toaster	Set



ELECTRIC COUNTERTOP  
**RollsRight COMMERCIAL  
 ROLLER GRILL**



EHD-50NS



EHD-30NS

Sneeze Guard  
 & Bun Drawer  
 Sold Separately

EHD-30NS with  
 EHD-30-SG &  
 EHD-30-BD



EHD-30NS and  
 EHD-50NS made with

MODEL	VOLTAGE	POWER (W)	AMPS	DIMENSIONS (INCHES)			LBS
				WIDTH	DEPTH	HEIGHT	
EHD-30NS	120V	1430W	12A	23.6"	20.5"	13.1"	41.01
EHD-50NS	120V	1760W	14.6A	35.4"	20.5"	13.1"	56.33



Non-Stick Rollers



**SPECTRUM ROLLER GRILLS** are engineered to give you long lasting cooking results under the harshest applications. They are perfect for convenience stores, concession stands, cafeterias and more. All grills come with our unique noise suppression motor and chain drive system. Dual temperature controls allow for both cooking and holding areas to operate independently, reducing waste and spoilage due to excessive overheating. Xylan® RollsRight non stick roller surfaces are durable and easy to clean. Spectrum Roller Grills come with full size grease drip pans and are UL, CUL, and NSF listed. Warranty and national onsite service program information can be found in the user manual.

- ◆ EHD-30NS: Up to 30 hot dog capacity
- ◆ EHD-50NS: Up to 50 hot dog capacity
- ◆ Stainless steel body and drip tray
- ◆ The rollers are coated using Whitford Xylan®, a fluoropolymer coating with superior resistance to wear and to all forms of abrasion
- ◆ Two-zone front and rear heating for cooking and warming simultaneously
- ◆ Multiple power levels to support different food products
- ◆ UL-listed for compliance with UL-197
- ◆ NSF-listed for compliance with NSF-4
- ◆ One year warranty

ITEM	DESCRIPTION	UOM
EHD-30NS	30-Dog Hot Dog Roller, Non-Stick with Xylan Coating	Set
EHD-50NS	50-Dog Hot Dog Roller, Non-Stick with Xylan Coating	Set





ROLLSRIGHT COMMERCIAL ROLLER GRILL  
**SNEEZE GUARD &  
 BUN DRAWER**



EHD-50-SG



EHD-50-SGD



EHD-30-BD



EHD-30-SGD



EHD-50-BD

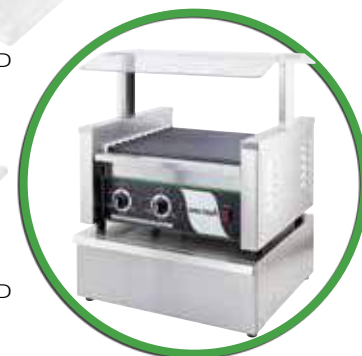

EHD-30NS with  
 EHD-30-SG and EHD-30-BD

MODEL	ITEM	DETAIL	DIMENSIONS (INCHES)			LBS
			WIDTH	DEPTH	HEIGHT	
EHD-30-SG	Sneeze Guard	Pass-Thru	24.375"	20.625"	9"	4.37
EHD-30-SGD	Sneeze Guard	Front Open Door	24.375"	21.275"	9.375"	4.5
EHD-30-BD	Bun Drawer	Holds Up to 36 Buns	23.5"	22"	8.5"	34.17
EHD-50-SG	Sneeze Guard	Pass-Thru	35.5"	20.625"	9"	5.95
EHD-50-SGD	Sneeze Guard	Front Open Door	36.175"	21.275"	9.375"	6.5
EHD-50-BD	Bun Drawer	Holds Up to 56 Buns	35.5"	22"	8.5"	49.6



**SPECTRUM ROLLER GRILLS** are engineered to give you long lasting cooking results under the harshest applications. They are perfect for convenience stores, concession stands, cafeterias and more. All grills come with noise suppression motor and chain drive system. Dual temperature controls allow for both cooking and holding areas to operate independently, reducing waste and spoilage due to excessive overheating. Xylan® RollsRight non-stick roller surfaces are durable and easy to clean. Spectrum Roller Grills come with full size grease drip pans and are UL, CUL, and NSF listed. Warranty and national onsite service program information can be found in the user manual.

- ◆ Sneeze guards increase sanitation and protect food from airborne contaminants
- ◆ Durable, protective panels allow customers a direct view of options
  
- ◆ Bun drawer adds convenience and saves space on the countertop
- ◆ Provides a sanitary holding area for hot dog buns
  
- ◆ One year warranty

ITEM	DESCRIPTION	UOM
EHD-30-SG	Sneeze Guard to fit EHD-30NS Hot Dog Roller	Each
EHD-30-SGD	Sneeze Guard w/Hinged Door to fit EHD-30NS	Each
EHD-30-BD	Bun Drawer to fit EHD-30NS Hot Dog Roller	Each
EHD-50-SG	Sneeze Guard to fit EHD-50NS Hot Dog Roller	Each
EHD-50-SGD	Sneeze Guard w/Hinged Door to fit EHD-50NS	Each
EHD-50-BD	Bun Drawer to fit EHD-50NS Hot Dog Roller	Each

Products count for 100% of their net price value, towards free freight program.



# ELECTRIC COUNTERTOP GRIDDLE



EGD-36



EGD-24

MODEL	VOLTAGE	POWER (W)	AMPS	DIMENSIONS (INCHES)			TEMPERATURES		LBS
				WIDTH	DEPTH	HEIGHT	°C	°F	
EGD-24	208/240 V	4200/5600W	20.2/23.4A	24"	21.7"	12.9"	65°-250°C	150°-480°F	92.92
EGD-36	208/240 V	6300/8400W	30/35A	36"	21.8"	12.9"	65°-250°C	150°-480°F	123.13



**SPECTRUM ELECTRIC GRIDDLES** feature a 1/2" polished steel grill surface with extra tall steel surround wall enclosures. The electric griddles have independent zone controlled heating that allow the operator to use any variety of heat settings from maximum grilling temperature to low warming and holding temperature. Spectrum Electric Griddles are NSF, CUL and UL approved. Warranty and national service program information can be found in the user manual.

- ◆ EGD-24: Two independently controlled heat zones, 24"W x 16-1/2"D grilling surface
- ◆ EGD-36: Three independently controlled heat zones, 36"W x 16-1/2"D grilling surface
- ◆ Stainless steel body and catch tray
- ◆ Stainless steel side and rear backsplash for food containment
- ◆ Solid steel plate with a 1/2" thickness on both EGD-24 and EGD-36
- ◆ EGD-24 supplied with a plug and lead (NEMA L6-30P) for quick installation/connection
- ◆ Adjustable feet
- ◆ UL listed for compliance with UL-197
- ◆ NSF listed for compliance with NSF-4
- ◆ One year warranty

ITEM	DESCRIPTION	UOM
EGD-24	Electric Griddle, 24", 240 Volts, with Plug and Lead	Set
 EGD-36	Electric Griddle, 36", 240 Volts	Set



# GAS COUNTERTOP HOT PLATE



GHP-4



Curved dome over pilot light protects from spills and food debris.



GHP-2

MODEL	# OF BURNERS	BTU/PER NAT/LP	TOTAL BTU/HR	PRESSURE IN. W.C	DIMENSIONS			LBS
					WIDTH	DEPTH	HEIGHT	
GHP-2	2	22,000	44,000	6 / 10	12"	26.75"	15"	58.75
GHP-4	4	22,000	88,000	6 / 10	24"	26.75"	15"	103.95

Note: Depths do not include gas inlet pipe, located at rear of the unit.



**SPECTRUM GAS HOT PLATES** come equipped with precision engineered manually controlled valves. The gas hot plates have dual pilot light assemblies that have individual gas feed lines to allow instant restarting if one pilot light goes out. Pilot lights are located away from the center of the burners and are covered under our specially designed burner trivets to keep them away from cooking debris. Spectrum Gas Hot Plates come with LP conversion kits and are ETL approved for sanitation and ANSI Z83.11 for U.S. and CSA 1.8b for Canada. Warranty and national onsite service program information can be found in the user manual.

- ◆ GHP-2: Two independently controlled burners
- ◆ GHP-4: Four independently controlled burners
- ◆ Stainless steel body, drip tray, and back splash
- ◆ Removable cast iron grills for easy cleaning
- ◆ Conversion kit allows the use of propane or natural gas
- ◆ Adjustable pilot light
- ◆ Adjustable feet
- ◆ ETL listed for safety and sanitation
- ◆ One year warranty

ITEM	DESCRIPTION	UOM
GHP-2	Gas 2 Open Burner Hot Plate & 1 Conversion Kit	Set
GHP-4	Gas 4 Open Burner Hot Plate & 1 Conversion Kit	Set



Conforms to ANSI STD  
Z83.11b-2009(R2012)  
Certified to CSA  
STD 1.8b-2009(R2012)



# GAS COUNTERTOP GRIDDLE



GGD-36M



GGD-24M

MODEL	# OF BURNERS	BTU/PER NAT/LP	TOTAL BTU/HR	PRESSURE IN. W.C	DIMENSIONS			GRILL SURFACE		LBS
					WIDTH	DEPTH	HEIGHT	WIDTH	DEPTH	
GGD-24M	2	30,000	60,000	6 / 10	24"	29.625"	15.6"	24"	20"	157.85
GGD-36M	3	30,000	90,000	6 / 10	36"	29.625"	15.6"	36"	20"	228.29

Note: Depths do not include gas inlet pipe, located at rear of the unit.



**SPECTRUM GAS GRIDDLES** come equipped with precision engineered manually controlled valves. All gas griddles have a 3/4" polished steel cook plate and full length 3" wide front rail for keeping spillage to a minimum. Spectrum Gas Griddles come with LP conversion kits and are ETL approved for sanitation and ANSI z83.11 for U.S. and CSA 1.8b for Canada. Warranty and national onsite service program information can be found in the user manual.

- ◆ GGD-24M: Two independently controlled heat zones, 24"W x 20"D grilling surface
- ◆ GGD-36M: Three independently controlled heat zones, 36"W x 20"D grilling surface
- ◆ Stainless steel body, sides, rear back splash, and catch tray
- ◆ Solid steel plate with a 3/4" thickness on both GGD-24M and GGD-36M
- ◆ Conversion kit allows the use of propane or natural gas
- ◆ Adjustable pilot light
- ◆ Adjustable feet
- ◆ ETL listed for safety and sanitation
- ◆ One year warranty

ITEM	DESCRIPTION	UOM
GGD-24M	Gas Griddle / Manual Controls & 1 Conversion Kit	Set
GGD-36M	Gas Griddle / Manual Controls & 1 Conversion Kit	Set



# GAS COUNTERTOP CHARBROILER



GCB-36R

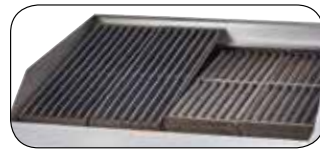

Plates can sit on an angle or flat for proper drainage.



Grooves direct excess oils into tray to prevent oil build up.



GCB-24R

MODEL	# OF BURNERS	BTU/PER NAT/LP	TOTAL BTU/HR	PRESSURE IN. W.C	DIMENSIONS			GRILL SURFACE		LBS
					WIDTH	DEPTH	HEIGHT	WIDTH	DEPTH	
GCB-24R	2	40,000	80,000	6 / 10	24"	27"	15.6"	24"	20"	142.31
GCB-36R	3	40,000	120,000	6 / 10	36"	27"	15.6"	36"	20"	209.22

Note: Depths do not include gas inlet pipe, located at rear of the unit.



**SPECTRUM GAS RADIANT CHARBROILERS** come equipped with precision engineered manually controlled valves. All radiant grill grids are designed to be reversible. Cooking can be done with grids leveled or reversed and placed into an angled position. Specially designed channels in the grids allow for excess cooking residue to travel easily into the grease pan. Spectrum Radiant Charbroilers come with LP conversion kits and are ETL approved for sanitation and ANSI Z83.11b for U.S. and CSA 1.8B for Canada. Warranty and national onsite service program information can be found in the user manual.

- ◆ GCB-24R: Two independently controlled burners, 24"W x 19"D grilling surface
- ◆ GCB-36R: Three independently controlled burners, 36"W x 19"D grilling surface
- ◆ Stainless steel body, drip tray, side and back splashes
- ◆ Removable cast iron grills and stainless steel baffles for easy cleaning
- ◆ Conversion kit allows the use of propane or natural gas
- ◆ Adjustable pilot light
- ◆ Adjustable feet
- ◆ Lava rock kits also available
- ◆ ETL listed for safety and sanitation
- ◆ One year warranty

ITEM	DESCRIPTION	UOM
GCB-24R	Gas Broiler / Radiant & 1 Conversion Kit	Set
GCB-36R	Gas Broiler / Radiant & 1 Conversion Kit	Set



Conforms to ANSI STD Z83.11b-2009(R2012)  
Certified to CSA STD 1.8b-2009(R2012)



FLATWARE	16
BUFFET SERVICE	34
TABLETOP	47
MELAMINE	64
DINING SERVICE	66
BEVERAGE SERVICE	86

DISPLAY	96
BAR SUPPLIES	101
PRO. CUTLERY	116
PRO. COOKWARE	133
STEAM TABLE PANS	148
POLY PANS/STORAGE	154

BAKEWARE	160
PIZZA SUPPLIES	181
FOOD PREP	190
KITCHEN UTENSILS	207
TEXTILES	244
JANITORIAL	250

SHELVING & RACKS	263
BUSSING/TRANSPORT	267
COUNTERTOP EQUIPMENT	276
<b>SPECTRUM</b>	289

**INDEX BY ITEM NUMBER**  
 Red indicates NEW item

**0-9**

0001	31
0002	31
0004	30
0005	25
0006	24
0007	26
0008	27
0010	26
0012	31
0014	31
0015	25, 32
0016	27
0019	28
0021	24
0024	30
0025	29
0026	28
0030-01 to 0030-19	16, 32
0030-21 to 0030-25	32, 44
0031	17
0033	23
0034	21, 32
0035	22
0036	20
0037	19
0039	18
0081	30
0082	30
101A	34
103A	34
108	35
201	37
202	37
203	37
207	39
211	39
308	35
408-1	37
508	37
601	36
602	36
602-FP	34, 36
603	36
708	37
901	41, 86
902	41, 86
903	40, 86
905	40, 86

**A**

AAD	237
AASP	166
ABBC	272
ACN	98
ACP-062 to ACP-123	165
ACP-0913 to ACP-1212	164

ACS	131
ACSD	78, 101
ACTD	78
ADB-12, -20	150
ADB-4	99, 149
ADBC	243
ADC	98
ADD	173, 188
ADO	54
ADP	153
ADRG	175, 185
AES	239
AFD	260
AFP	144, 208
AFP-7 to AFP-14 Series	139
AFPI	138
AHC	243
AICD	215
ALB	142
ALBC	272
ALBH	142
ALBP	143
ALD	213
ALDB	145
ALDP	172, 186
ALHP	142
ALO	199
ALPC	142
ALRC-5H, -5HK, -5STK	162, 267
ALRC-5P	163, 268
ALRC-5ST	162, 267, 272
ALRK-10, -20	162, 267
ALRK-10BK to -30BK	162, 267
ALRK-10-CV, -20-CV	162, 267
ALRK-3, -15	163, 268
ALRP	143
ALSB	145
ALSP	147
ALST	142
ALXP-0609, -1013, -1318	73, 160
ALXP-1200	160
ALXP-1310H	143, 160
ALXP-1622 to -2618H	143, 160
AM	180, 225
AMF	167
AMS	183
AMT	240
AP	88
AP-12	197
APCD	174, 206
APHS	188
APL	54
APM	165
APP-10M to APP-18L	184
APP-20	184, 242
APP-26 to APP-52	184
APPL	165
APRK	89
APS	145
APSK	88
APSP	88

APZC	181
APZK	181
APZN	181
APZP-10P to APZP-20P	182
APZP-10SP to APZP-20SP	182
APZS	183
APZT-7 to APZT-20	181
APZT-789, -1015	183
ARP	173, 187
AS	234
ASDR	266
ASET	142
ASFB	234
ASFP	144
ASFT	61, 76, 97
ASP-1 to ASP-10	144
ASP-1C to ASP-10C	144
ASP-2C	138, 144
ASS	230
AST	98
ATC	77
ATCH	67
AWRK	162, 267
AXAP	141
AXBZ	141
AXHA	140
AXHB	140
AXHH	140
AXPE	161
AXS	141
AXS-16C, -20C, -40C	138, 140-142
AXS-32C, -60C, -80C	140-141
AXSI	138
AXST	141
AXTI	138

**B**

BA	246
BAM	153
BAMC	153
BAMN	152
BC	101
BCH-14	105
BCS	59
BFM	208
BGDV	81, 189, 273
BGPZ	81, 189, 273
BHFK	217
BHKP	217
BHKS	217
BHON	216
BHOP	217
BHPN	216
BHSN	216
BHSP	217
BL	113
BL-28P, -3P	102
BLS	103

BM	113
BML	113
BPS	103
BR-10, -21, -27, -30	189, 258
BR-15	261
BR-24, -28	257
BR-25	94, 257
BR-319, -500	259
BR-36W, -60W	189, 255
BR-7B, 7S	259
BR-9, -12, -31	258
BRF	255
BRM	81, 255
BRM-60L	81, 255
BRN	257
BRP	257
BS	102
BS-64	92
BSFK	217
B SOB	217
BSON	216
BSOT	217
BSPB	217
BSPN	216
BSPT	217
BSSB	217
BSSN	216
BSST	217
BST	103
BTGP	114, 247, 256
BTH	114, 247, 256
BTM	114, 247, 256
BTW	114, 247
BW	44
BXC	250

**C**

C-1080	38
C-2080B	38
C-2F, -3F	39
C-3080B	38
C-4080	38
C-5080	36
C-6080	36
CB	204
CBBN	205
CBBU	205
CBEL	77
CBF	205
CBGR	205
CBH	204
CBI	204
CBN	203
CBPP	205, 207
CBR	205, 257
CBRD	205
CBS-1	109
CBST	205
CBWT	104, 204

CBWT-1218 to CBWT-1830..... 204  
 CBWT-610..... 104, 204  
 CBXH..... 204  
 CBYL..... 205  
 CC..... 170  
 CCB..... 229  
 CCH..... 101  
 CCK..... 80  
 CCM..... 279  
 CCOD..... 199  
 CCP..... 166  
 CCS..... 229  
 CD..... 94  
 CDB..... 94, 257  
 C-DCF, -DCH..... 150  
 CDIC..... 95  
 CDP..... 101  
 C-DP, C-DPF Series..... 98, 154  
 CDR..... 95  
 CDT..... 169  
 CDTC..... 169  
 CEP..... 135  
 CF..... 91  
 C-F1..... 34-38  
 C-F2, -F4, -F6..... 39  
 CGS..... 83  
 CGSF..... 83  
 CH..... 246  
 CHB..... 82  
 C-HDC..... 150  
 C-HFC..... 150  
 CHH..... 82  
 CHK..... 77  
 CJ..... 60  
 CKM..... 164  
 CKS..... 98, 168  
 CKSR..... 168  
 CLO..... 95  
 CLR..... 79  
 CLSO..... 95  
 CMF..... 167  
 CMM..... 51, 102  
 CMT..... 43, 71  
 CO-1, -1B, -1G..... 193  
 CO-201..... 105  
 CO-3, -3B, 3G..... 193  
 CO-201 to -720..... 105  
 CO-402..... 105  
 COD..... 199  
 CODS..... 229  
 CPSF..... 166  
 C-RCF..... 99, 150  
 CRD..... 278  
 CRK..... 97, 159  
 CRKC..... 97, 159  
 C-RTC..... 36  
 CS-1, -3..... 77  
 CS-2014..... 167  
 CS-44P, -44W..... 131, 238  
 CSF..... 254  
 CSFP..... 136  
 CSP..... 94  
 CSPP..... 49, 136  
 CST..... 170  
 CSW..... 54  
 CT..... 268  
 CU..... 292

C-WPF..... 36-38, 149  
 C-WPF6, -WPP..... 149  
 CXP..... 161

**D**

DB..... 163  
 DCA..... 269  
 DCCR..... 47  
 DCFP..... 47  
 DCH..... 246  
 DCL..... 47  
 DCSC..... 47  
 DCSP..... 47  
 DCWA..... 48  
 DCWB..... 48  
 DCWC..... 48  
 DCWD..... 48  
 DCWE..... 48  
 DDSA..... 51  
 DDSB..... 49  
 DDSC..... 48  
 DDSD..... 51  
 DDSE..... 51, 102  
 DDSF..... 78  
 DDSG..... 59  
 DDSH..... 52  
 DDSI..... 52  
 DLR..... 253  
 DM..... 255  
 DP..... 81, 255  
 DRG..... 175, 185  
 DSC..... 172, 187  
 DSSD..... 51  
 DT..... 41, 90  
 DWAB..... 96  
 DWCC..... 69, 111  
 DWR-1708..... 253  
 DWR-2617..... 159, 186, 268

**E**

ECO..... 285  
 ECT..... 293  
 ECW..... 94, 278  
 EDM..... 277  
 EFS..... 283  
 EFT..... 283  
 EGD..... 296  
 EGR..... 243  
 EGRS..... 243  
 EHD-30-BD, -50-BD..... 295  
 EHD-30NS, -50NS..... 294  
 EHD-30-SG, -50-SG..... 295  
 EHD-30-SGD, -50-SGD..... 295  
 EHL..... 282  
 EIC..... 281  
 EIZ..... 262  
 EMW-1000SD..... 291  
 EMW-1000ST..... 290  
 EPG..... 284  
 EPO..... 285  
 ESG..... 284  
 ESH..... 283  
 ESM..... 276  
 ESW..... 287  
 EWP-2..... 39, 281

**F**

FAUCET-CU, -JD..... 40, 86

FB..... 147  
 FBM..... 50  
 FBR..... 147  
 FBRS..... 147  
 FC..... 81, 269  
 FCS..... 196  
 FCW..... 158, 253  
 FCW-10ICE, -20ICE..... 107  
 FF-10, -RC..... 147, 243  
 FFB..... 147, 243  
 FFC..... 193  
 FFT-1014B to FFT-1418U..... 72  
 FFT-1826, -1826YL..... 160  
 FGMT..... 99  
 FGT..... 72  
 FGTT..... 72  
 FMC..... 251  
 FN..... 221  
 FPCM..... 51, 94  
 FPP-1 to FPP-8..... 214  
 FPP-2P, -4P, -6P..... 208  
 FPPN-1 to FPPN-8..... 214  
 FPS-1 to FPS-8..... 214  
 FPS-2P, -4P, -6P..... 208  
 FPSN-1 to FPSN-8..... 214  
 FPT3..... 134  
 FQP..... 165  
 FS..... 54, 137  
 FS-1313..... 243  
 FS-2, -2-UL..... 54, 137  
 FSC-60H..... 254, 255  
 FSP..... 241  
 FSS..... 254  
 FST..... 128, 226  
 FSW..... 81, 255  
 FTNS..... 72  
 FVS..... 191  
 FW..... 280  
 FWS..... 191

**G**

GBH..... 259  
 GBK..... 259  
 GBS..... 59  
 GCB..... 299  
 GCR..... 127  
 GGD..... 298  
 GH..... 113  
 GHC..... 113  
 GHP..... 297  
 GHT..... 92  
 GLC..... 250  
 GLP..... 250  
 GOB..... 56  
 GP..... 239  
 GR..... 103  
 GRTS..... 75, 131  
 GS..... 92  
 G-Series..... 57  
 GSH..... 259  
 GSN..... 259  
 GT-103 to GT-106..... 75, 236  
 GT-201 to GT-401..... 236  
 GWB..... 114, 257

**H**

HAC..... 165, 182  
 HAG..... 137

HCD..... 192  
 HDH..... 137, 248  
 HDM..... 276  
 HFC..... 190  
 HFS..... 262  
 HLF..... 164  
 HP..... 240  
 HPO..... 42, 96  
 HPR..... 42, 96  
 HPS..... 42, 96  
 HRCP..... 164  
 HRS..... 42, 96  
 HSCP..... 164  
 HSP..... 166  
 HTS..... 83

**I**

IB-21, -27..... 158, 273  
 IB-2S, 5S, 10S..... 158  
 IB-C3, C3B..... 158, 273  
 ICB..... 111  
 ICC..... 58  
 ICCT..... 106  
 ICD-10P, -12P, -16P, -20P..... 208  
 ICD-6 to ICD-40..... 215  
 ICH..... 107  
 ICOP..... 215  
 ICP..... 106  
 ICR..... 163  
 ICS..... 215  
 ICT..... 45, 107, 219  
 IFPC..... 274  
 IFT..... 274  
 IGD..... 137  
 IGL..... 137  
 IIC..... 107, 273  
 INS-2.5, -4.0..... 153  
 INS-7.0M, -11.0M..... 39, 153  
 INSC..... 152, 153  
 INSC-7M, -11M..... 39, 152, 153  
 INSH-7, -11..... 39, 153  
 INSN..... 152  
 IS..... 234  
 ISP..... 54, 137  
 ISS..... 215  
 IT..... 45, 107, 219

**J**

JB..... 92  
 JC-4..... 104, 237  
 JC-16..... 104  
 JC-19..... 104  
 J-series..... 103  
 JST..... 103

**K**

K-12S to K-54S..... 124  
 K-35W to K-438W..... 33, 132  
 K-40P..... 126  
 K-4G..... 124  
 K-50P to K-85P..... 33, 132  
 KB..... 33, 132  
 KBG..... 127  
 KC-101 to KC-601..... 126  
 KCC..... 130  
 KCL..... 130, 241  
 KCP..... 131  
 KCS..... 75, 131



KDB.....49  
 KFP-122, -123 ..... 119, 124  
**KFP-35 to KFP-120..... 116-118**  
 KFP-71, -121, -140, -180 ..... 118, 242  
 KFP-72.....126  
 KFP-BLKA.....119  
 KFP-KITA.....119  
 KPF.....126, 242  
 KPP.....130, 184  
 KR.....126  
 KS.....125, 238  
**KSP.....125**  
**KWP-30 to KWP-123 ..... 120-121**  
 KWP-30P, -80P, -91P ..... 209  
 KWP-100P, -121P ..... 209  
 KWP-48.....221

**L**  
**LC-01 to LC-85 .....76, 241**  
 LC-04.....76, 239, 241  
 LDC-05 to LDC-12 ..... 213  
 LDC-2P, -4P, -6P.....208  
**LDCN-1 to LDCN-8K ..... 212, 212**  
 LDI.....213  
**LDIN.....212**  
 LDS.....213  
 LDT.....213  
 LE.....44  
 LED.....83  
 LMD.....66  
 LMF.....66  
**LMS.....66**  
 LMTD.....66  
 LMTT.....66  
 LS-3.....104  
 LS-8G, -9O, -9Y ..... 104, 237

**M**  
 MAS.....79, 114  
 MB.....85, 100  
 MB-1.....237  
 MBAF.....85, 100  
 MBB.....85, 100  
 MBBE.....85, 100  
 MBM.....85, 100  
 MBPM.....85, 100  
 MCP-30 ..... 102  
 MCP-4P ..... 180, 225  
 MCPP.....180, 224  
 MDL.....196  
 MH.....43, 68  
 MHH.....255  
 MMB.....64  
 MMPO.....64  
 MMPR.....64  
 MMPT.....64  
 MMSC.....65  
 MMU.....65  
 MOP.....254  
 MOPH.....254  
 MPB.....254  
 MPD.....179, 186  
 MPF.....146, 228  
**MPN.....146, 228**  
 MPS.....104, 197  
 MPSP.....146, 228  
 MS2K.....231

MS2K-3S.....103, 175  
 MS3A.....231  
 MSB.....231  
 MSH.....231  
**MSL.....180, 213, 224**  
 MSP.....180, 224  
 MSPD.....180, 224  
 MSPP.....180, 224  
 MSS.....230  
 MST.....231  
 MSTF.....231  
 MT.....240  
 MWP.....221  
 MXB.....198  
 MXBH.....198  
 MXBS.....198  
 MXBT.....198  
 MXHV.....198  
 MXRU.....198

**N**  
 NACP.....166  
 NB.....176  
 NC.....222  
 NH.....78  
 NLG.....250  
 NLGH.....250  
 NPM.....195  
 NS.....179, 222  
 NSP.....179, 222  
 NTHM.....166

**O**  
 OC.....232  
 ODR.....77  
 OGZ.....81, 269  
 OM.....176  
 OMF.....177, 248  
 OMS.....177, 248  
 OMT.....177, 248  
 OP.....114, 262  
 OPL.....54, 71  
 OS.....191

**P**  
 PBB.....61, 97  
 PBC.....169  
 PBD.....87  
 PBDW.....87, 159  
 PBM.....104  
 PBST.....176, 232  
 PC-1.....109  
 PCB.....81, 269  
 PCM.....165  
 PCRC.....157  
 PCSC.....156  
 PDG.....175, 185  
 PDS.....172, 187  
 PDT.....93  
 PECC.....156, 208  
 PESC.....156  
 PF.....174, 232  
 PFB.....63, 73  
 PFBT.....110  
 PFFW.....155  
 PFHW.....155  
 PFSF.....155  
 PFSH.....155

PGS.....281  
**PGW.....151, 161**  
**PGWS.....151, 161**  
 PH.....134  
 PH-811W.....144, 248  
 PH-8B, -8S, -9W .....248  
 PK.....74, 101  
 PK-A35, -C2, -C4.....74  
 PK-P4, -S3.....74, 101  
 PKT.....110  
**PKTS.....58, 74**  
 PL.....81, 269  
**PL-3N, -6N, -36NC ...159, 172, 186**  
 PL-4B.....81, 269  
 PL-57B to PL-57W .....270  
 PL-5G, -5K, -5W .....270  
 PL-7B, -7K, -7W .....270  
 PL-8.....271  
 PLB.....63, 73  
 PLD.....46, 220  
 PLK.....238  
 PL-MB, -MBC.....271  
 PLP.....271  
 PLSP.....194  
 PLTC.....271  
 PLW.....270  
 PMB.....126  
 PMC.....67  
 PMCD.....67  
 PMCF.....67  
 PMCP.....179, 225  
 PMCT.....67  
 PMG.....127, 241  
 PMP.....55  
 PMSB.....55  
 PMU.....179, 225  
 PN.....221  
 POA.....238, 262  
 POB.....63, 73  
**POP.....279**  
 PP.....108  
 PPA.....108  
 PPB.....110  
 PPC.....130, 184  
 PPC-ID.....173  
 PPG.....183  
 PPH.....59  
 PPL.....256  
 PPM.....109  
**PPM-2.....77**  
 PPR.....108  
 PPRC.....157  
 PPT.....46, 220  
 PR-05P, 05S .....57  
 PR-9, -16 .....221  
 PRTS.....75, 131  
 PS.....234  
 PSB.....74, 233  
 PSBW.....61, 97  
 PSC.....178, 223  
 PSD.....178, 223  
 PSG.....178, 223  
 PSGE.....178, 223  
**PSH.....178, 207, 223**  
 PSM.....240  
 PSN.....58  
 PSR.....256

PSS.....46, 220  
 PSSB.....46, 220  
 PST.....173  
 PSTCO.....173  
**PSUD.....59, 233**  
 PSW.....74, 233  
 PT.....45, 219  
 PTC.....252  
 PTCB.....252  
 PTCL.....252-253  
 PTCF.....252  
 PTM.....221  
 PTMCO.....221  
 PTMP.....221  
 PTOS.....45, 219  
 PTP.....93  
 PTRC.....157  
 PTS.....50  
 PTSC.....156  
 PTSN.....93  
 PTW.....55  
 PUT.....46, 220  
 PUTF.....46, 220  
 PWBK-1914T ..... 62, 99  
 PWBK-88R to PWBK-156V .....62  
 PWBK-8R, -9B, -9V.....62  
 PWBN-12B, -16B, -1914T ..... 62, 99  
 PWBN-88R to PWBN-156V .....62  
 PWBN-9B to PWBN-9V .....62  
 PWC.....130, 184  
**PZG.....185**  
**PZP.....184**

**R**  
 RBM.....251  
 RBMH.....251  
 RBMI.....251  
 RBMM.....251  
 RC.....286  
 RD.....173, 188  
 RFM.....58  
 RFS.....174, 188  
 RP.....58  
 RS.....60  
 RSB.....262  
 RSK.....137  
 RVS.....77  
 RW.....287

**S**  
 SAF.....174, 232  
 SAP.....137  
 SAS.....79, 114  
 SBD.....90  
 SBF.....164  
 SBM.....104  
**SBMW.....52**  
 SBR.....60  
 SBS.....161, 207  
 SBW.....60, 76  
 SC.....230  
**SCAL.....194**  
 SCB.....81, 269  
 SCC.....237  
 SCD.....94  
 SCF.....230  
 SCLH.....194  
 SCP.....58  
 SCR.....259



SCS.....	230	SP7904.....	154	STR.....	163	VCB.....	264
SCT.....	59	SP-96N.....	256	STRS.....	71, 112	VCCD.....	263
SCU.....	165	SPB.....	40, 86	STS.....	44	VCH.....	263
SD-100.....	260	SPBR.....	233	SUC.....	272	VCS.....	263
SD-3, -5.....	60	SPC-3.....	237	SVM.....	197	VEX.....	265
SDA.....	241	SPC-7H.....	135	SWA.....	240	VEXB.....	265
SDC.....	168	SPCF.....	150	SWU.....	54	VEXS.....	263
SDP.....	78, 101	SPCH.....	150			VM.....	266
SES.....	239	SPCN.....	150	<b>T</b>		VP-1, -2.....	239
SF-5, -6, -6S.....	174, 232	SPCQ.....	150	T-710.....	60	VP-300 to VP-308, VP-310.....	235
SF-7, -7R.....	174, 260	SPCS.....	150	TB.....	147	VP-309, VP-311 to VP-313...131, 235	
SFAC.....	250	SPCT.....	150	TBC.....	80, 247	VP-314.....	130, 235, 241
SFC.....	50	SPCTT.....	150	TBCO.....	80, 247	VP-315, -316.....	130, 184
SFCW.....	50	SPF1.....	148	TBCS.....	80, 247	VSS.....	91
SFR.....	61, 76, 97	SPF2.....	34-38, 148	TBH.....	68	VSW.....	91
SGN-101 to SGN-205.....	41, 90	SPF2-HD.....	38, 149	TBN.....	68	VTs.....	197
SGN-301 to SGN-382W.....	84	SPF4.....	148	TCD.....	43, 68		
SGN-601 to SGN-684W.....	84	SPF6.....	148	TCHS.....	50	<b>W</b>	
SGN-801 to SGN-805.....	83	SPFB.....	151	TCK.....	70, 112	W612 to 670.....	92
SGNB-601 to SGNB-653B.....	84	SPFD2.....	149	TD-120, -120S, -220.....	261	WA.....	80, 247
SHHD.....	213	SPFD-2R.....	34-36, 149	TD-300 to TD-700.....	260	WB.....	69, 111
SIK.....	262	SPFP.....	149	TDS.....	42, 96	WBKG.....	63
SIV.....	174	SPG.....	256	TDSF.....	42, 96	WBKH-5, -10.....	50
SIZ.....	54	SPH1.....	148	TFG.....	70, 112	WBKH-6R, -6SB, -7R.....	56
SK.....	33, 132	SPH2.....	148	TIM.....	177	WBR.....	176
SKO.....	240	SPH4.....	148	TKP-30 to TKP-91.....	129, 227	WBRP.....	176
SLO.....	199	SPH6.....	148	TKP-62.....	185	WBS.....	109
SMB.....	180, 198	SPHP.....	149	TKPO.....	129, 168, 227	WC.....	69, 111
SMT.....	73	SPJH.....	148	TKPS.....	129, 168, 227	WCB.....	204
SND.....	60, 76	SPJL.....	148	TLC.....	192	WCB-125.....	75, 204
SP-612, -624.....	53	SPJL-2HL, -4HL, -6HL.....	149	TMT.....	202	WCH.....	80
SP7100C.....	154	SPJL-HCN, -HCS.....	149	TN.....	128, 226	WCS.....	254
SP7100S.....	154	SPJM.....	148	TNH.....	128, 226	WFB.....	176
SP7102.....	154	SPJP.....	148	TNS.....	128, 168	WG10.....	102
SP7104.....	154	SPM.....	171, 210	TOS.....	128, 168	WH.....	56
SP7106.....	154	SPN.....	148	TP.....	261	WHW-4, -7.....	234
SP7108.....	154	SPP.....	182	TPC.....	55, 195	WHW-5, -10.....	250
SP71DS.....	154	SPQ.....	148	TR.....	70	WKCS.....	136
SP7200C.....	154	SPR.....	110	TRH.....	70, 112	WKR.....	136
SP7200S.....	154	SPS-2, -4, -6.....	148	TSC-10, -250.....	261	WLC.....	165
SP7202.....	154	SPS.....	211	TSC-2.....	237	WMB.....	126
SP7204.....	154	SPSC.....	150	TSY.....	70	WMW.....	104
SP7206.....	154	SPT.....	148	TT.....	77	WOK.....	136
SP7208.....	154	SPTT.....	148	TTG.....	211	WP.....	94
SP72DS.....	154	SQG.....	236	TTH.....	261	WPB.....	92
SP7300C.....	154	SR-GA421H.....	286	TTS.....	190	WPC.....	93
SP7300S.....	154	SRS-2, -8.....	44	TW.....	79	WPCB.....	93
SP7302.....	154	SRS-6.....	29, 237	TWP-30 to TWP-91.....	129, 227	WPCT.....	93
SP7304.....	154	SRT.....	239	TWP-31P to -91P.....	209	WPG.....	92
SP7306.....	154	SS.....	124	TWPO.....	129, 168, 227	WPIT.....	93
SP7308.....	154	SSBD.....	87	TWPO-9P.....	209	WPM.....	53
SP73DS.....	154	SSC.....	234	TWPS.....	129, 168, 227	WPMP.....	53
SP7400C.....	154	SSD.....	175	TWPS-9P.....	209	WPP.....	184
SP7400S.....	154	SSDB.....	135			WPS.....	93
SP7402.....	154	SSET.....	133	<b>U</b>		WPST.....	229
SP7404.....	154	SSFP.....	134	UC.....	272	WR.....	252
SP7406.....	154	SSLB.....	133	UNF.....	244-245	WRP.....	173, 187
SP74DS.....	154	SSOP.....	133	UP.....	206	WS.....	254
SP7600C.....	154	SSS.....	230	USF.....	261	WSK.....	240
SP7600S.....	154	SSSP.....	133	UT-7 to UT-16LT.....	218	WSP.....	179, 222
SP7602.....	154	SST.....	133	UT-7K.....	219	WSS.....	254
SP7604.....	154	SSTC.....	133-135	UTLK.....	219	WWB.....	61
SP7606.....	154	ST.....	45, 219	UTPH-9B to UTPH-16Y.....	218	WWP.....	179, 222
SP76DS.....	154	STB.....	92	UTPH-9P, -12P, -16P.....	208		
SP7900C.....	154	STH.....	45, 219	UTS.....	219	<b>X</b>	
SP7900S.....	154	STN-3.....	206, 242			XLB.....	106, 288
SP7902.....	154	STN-6, -8.....	242	<b>V</b>			
				VC.....	264		



FLATWARE	16
BUFFET SERVICE	34
TABLETOP	47
MELAMINE	64
DINING SERVICE	66
BEVERAGE SERVICE	86

DISPLAY	96
BAR SUPPLIES	101
PRO. CUTLERY	116
PRO. COOKWARE	133
STEAM TABLE PANS	148
POLY PANS/STORAGE	154

BAKEWARE	160
PIZZA SUPPLIES	181
FOOD PREP	190
KITCHEN UTENSILS	207
TEXTILES	244
JANITORIAL	250

SHELVING & RACKS	263
BUSSING/TRANSPORT	267
COUNTERTOP EQUIPMENT	276
<b>SPECTRUM</b>	289

**INDEX BY ITEM NAME**  
Red indicates **NEW** item

**A**

Adaptor Bars.....	150
Adaptor Plates.....	153
Adaptor, Angled Display....	98, 149
Air Freshener, Automatic.....	260
Airpot Rack.....	89
Airpots.....	88
Allergen Free.....	207-209
Angled Display Adaptor....	98, 149
Apple Corer/Divider.....	237
Apple Peeler.....	197
Apron, Bistro.....	80, 247
Apron, Waist.....	80, 247
Aprons, Bib.....	246
Ashtrays.....	79, 114
Augratin Dishes.....	54

**B**

Bags, Delivery.....	81, 189, 273
Bags, Pizza.....	81, 189, 273
<b>Bain Marie Covers.....</b>	<b>152-153</b>
<b>Bain Maries, S/S.....</b>	<b>152-153</b>
<b>Bain Maries, S/S, NSF.....</b>	<b>152</b>
Bake Pans, Alu.....	143
Bake Pans, Layer Cake....	164-165
Baking Mats, Silicone....	161, 207
Bar Liners.....	113
Bar Shakers.....	102
Bar Spoon.....	103
Bar Strainer.....	103
Basket, Cutlery.....	81, 269
Baskets, Bread.....	63
Baskets, Fast Food.....	63, 73
Baskets, Fruit.....	63
Baskets, Oval, Plastic.....	63, 73
Baskets, Platter, Plastic.....	63, 73
Baskets, Woven, Poly.....	62, 99
Baster, Plastic.....	176, 232
Basting Forks.....	217
Basting Spoons.....	217
Batter Dispenser.....	174, 206
Beer Layering Spoon.....	103
Beer Mug Washer.....	114, 257
Beer Pitcher.....	93
Bell Pitchers.....	92
Beverage Dispensers.....	87
Bev Dispensers, Insulated.....	90
Beverage Server, Insulated....	91
Beverage Server, S/S.....	92
Bin, Cutlery Organizer.....	81, 269
Bin, Mini.....	271
Bins, Ingredient.....	158, 273
Bins, Shelf Ingredient.....	158
<b>Blender.....</b>	<b>106, 288</b>
Blenders, Pastry.....	173

<b>Blini Pan.....</b>	<b>49</b>
Booster Seats.....	82
Bottle Cap Holder.....	105
Bottle Openers.....	105
Bottle Stoppers.....	109
Bottles, Juice Pour.....	110
Bottles, Liquor Pour.....	110
Bouillon Cups, Melamine.....	65
Bowl, Kady.....	49
Bowl, Shell.....	61, 97
Bowl, Sugar.....	60
Bowls, Angled Display.....	96
Bowls, Melamine.....	64-65
Bowls, Mixing.....	198
Bowls, Pebbled.....	61, 97
Bowls, Salad.....	61
Bowls, Salsa.....	55
Box Cutter.....	250
Brazier Covers, S/S.....	133-134
Braziers, Alu.....	140-142
Braziers, S/S.....	133
Bread Baskets, Wire.....	63
Bread Board.....	75, 204
Bread Form, Silicone.....	164
Broom Organizer.....	255
Broom Racks.....	255
Brooms.....	81, 255
Brush Handle.....	189, 255, 258
Brush Head, Floor.....	255
Brush, Broiler.....	258
Brush, Butcher Block.....	258
Brush, Coffee Urn.....	94, 257
Brush, Decanter.....	94, 257
Brush, Fryer.....	257
Brush, Glass.....	114, 257
Brush, Grill.....	258
Brush, Kettle Valve.....	257
Brush, Oven.....	189, 258
Brush, Pizza Oven.....	189, 258
Brush, Pot.....	257
Brush, Toilet.....	261
Brush, Utility.....	259
Brush, Wire.....	259
Brushes, Cutting Board.....	205, 257
Brushes, Pastry.....	176
Buckets, Cleaning.....	256
Buffet Servers.....	44
Buffet Spoons, PC.....	46, 220
Bun Drawers.....	295
Bus Box Cart.....	272
Bus Box Covers.....	270
Bus Box, Perforated.....	271
Bus Boxes.....	270
Bus Boxes, Divided.....	271
Butane Stove.....	281
Butter Curler.....	235
Butter Spreader.....	233
Butter Warmer.....	60, 76

**C**

Cake Markers, Alu.....	165
Cake Markers, Plastic.....	165
Cake Markers, S/S.....	164
Cake Pan, Anodized Alu...165, 182	
Cake Pan, Fluted.....	166
Cake Pans, Aluminized Steel...164	
Cake Pans, Angel Food.....	166
Cake Pans, Springform.....	166
Cake Pans, Turk Head Mold.....	166
Cake Stand & Cover.....	98, 168
Cake Stand, Revolving.....	168
Call Bells.....	77
Can Openers.....	105
Can Openers-Commercial & Manual.....	193
Carafe Lid.....	91
Carafes.....	91
Cart, Lug Box.....	272
Cast Iron Skillets.....	137
<b>Cast Iron Wok.....</b>	<b>54</b>
Caster, Mixing Bowl Stand....	198
Casters, Dolly.....	253
Casters, S/S Trolley.....	272
Casters, Sheet Pan Rack.....	162-163, 267
Casters, Shelving.....	266
Casters, Universal Plate.....	268
Caution Signs.....	254
Chafer Covers.....	36
Chafer Fuel Can.....	39
Chafer Stand.....	39
Chafers.....	34-38
Chain Signs.....	41, 90
Char Broilers, Gas.....	299
Check Caddy.....	77
<b>Check Holder.....</b>	<b>77</b>
Check Spindle.....	77
Cheese Board.....	75, 204
Cheese Grater, Rotary...75, 131, 236	
Cheese Graters.....	75, 131, 235
Cheese Knives.....	75, 131
Cheese Plane.....	131, 235
Cheese Slicer.....	131, 238
Cheese Slicer, Alu.....	131
Chef Hats.....	246
Chef Jackets.....	245
Chef Pants.....	245
Chef Shirts.....	244
Cherry Corer.....	237
Chopper/Dicers.....	192
Citrus Squeezers.....	104, 237
Cleaning Buckets.....	256
Cleavers.....	126
Coat Check Tickets.....	80
Coat Hangers.....	80
Cocktail Picks.....	74, 101
Cocktail Shakers.....	102

Cocktail Strainer.....	103, 175
Coffee Decanters.....	94
Coffee Knock Box.....	94
Coffee Press, French.....	51, 94
Coffee Scoop.....	94
Coffee Servers.....	94
Coffee Urn, Electric.....	292
Coffee Urns.....	40, 86
Coffee Warmer, Electric...94, 278	
Colander, Scoop.....	229
Colanders.....	199
Condiment Caddy, Wire.....	56
<b>Condiment Dispenser.....</b>	<b>58, 74, 195</b>
Condiment Holders.....	56
Condiment Jar Covers.....	60
Condiment Jars.....	60
Condiment Organizers.....	101
Condiment Servers.....	101
<b>Convection Ovens.....</b>	<b>285</b>
Cookie Cutters.....	170
Cookie Sheet.....	167
Cooking Tools, Nylon.....	179, 222
Cookware Set, S/S.....	135
Corer, Apple.....	235
Corer, Cherry.....	237
Corer, Pineapple.....	237
Corkscrews.....	105
<b>Cotton Candy Machine.....</b>	<b>279</b>
<b>Counterfeit Pen.....</b>	<b>77</b>
Coupler Set.....	169
Cover, Dough Box..159, 172, 186	
Cover, Hamburger.....	243
Cover, Liquor Pourer.....	109
<b>Covers, Bain Marie.....</b>	<b>152-153</b>
Covers, Bus Box.....	270
Covers, Deli Crock.....	97, 159
Covers, Dish Box.....	270
Covers, Double Boilers, S/S...135	
Covers, Food Storage Box, PP...155	
Covers, Food Storage, PC....157	
Covers, Food Storage, PP....157	
Covers, Fry Pans, S/S.....	133-134
Covers, Grill Basting.....	243
Covers, Inset.....	39, 152-153
Covers, Mini Bin.....	271
Covers, Sauce Pots, Alu...138, 144	
Covers, Stock Pot, Alu.....	138, 140-142
Covers, Stock Pots, S/S...133-135	
Covers, Trash Can.....	252
Covers, Wok, S/S.....	136
Creamer, Insulated.....	91
Creamers, S/S.....	59
Crocks, Deli.....	97, 159
Cruet, Oil/Vinegar.....	56
Culinary Baskets.....	231
Cup & Lid Organizers.....	95

Cup Dispensers.....95  
 Cups, Melamine.....65  
 Cutlery Bin.....81, 269  
 Cutlery Organizer.....81, 269  
 Cutters & Acces., French Fry.....190, 193  
 Cutters, Pizza.....130, 184  
 Cutting Board.....204-205, 207  
 Cutting Board with Hook.....203  
 Cutting Board, Wooden.....204  
 Cutting Boards...104, 203-205, 207  
 Cutting Mats.....204-205  
 Cylinders, Flatware.....81, 269

**D**

Decanters.....94  
 Decanters, PC.....93  
 Decorating Combs.....168  
 Decorating Tip Set.....169  
 Decorative Picks.....74, 101  
 Deep Fryers.....283  
 Deli Crock Covers.....97, 159  
 Deli Crocks.....97, 159  
 Delivery Bags.....81, 189, 273  
 Dipper, Alu.....213  
 Dish Box Cart.....272  
 Dish Box Covers.....270  
 Dish Boxes.....270  
 Dish Boxes, Divided.....271  
 Dish Caddy.....269  
 Dish, Ice Cream.....58  
 Dish, Sherbert.....60  
**Dishers, Portion Control.....215**  
 Dishes, Melamine.....64-65  
 Dispenser, Syrup.....59, 233  
 Dispenser, Toilet Seat Cover...261  
 Dispensers, Paper Towel.....260  
 Dispensers, Toilet Paper.....261  
 Display Cases, Acrylic.....98  
**Display Merchandisers.....277**  
 Display Trays, Acrylic.....98  
 Dividers, Dough.....173, 188  
 Dollies.....253  
 Dolly, Food Pan.....274  
**Dolly, Wire.....253**  
 Dome Covers, Hinged, PP.....98, 154  
 Dome Covers, PP.....98, 154  
 Double Boilers, Alu.....145  
 Double Boilers, S/S.....135  
 Dough Box.....159, 172, 186  
 Dough Box Cover...159, 172, 186  
**Dough Box Dolly .... 159, 186, 268**  
 Dough Roller Dockers....173, 188  
 Dough Scrapers, Plastic.....172, 187, 207  
 Dough Scrapers, S/S.....172, 187, 207  
 Doughnut Cutter.....170  
 Dought Basket.....163  
 Drain Shelves, PC.....154  
 Dredges, Alu.....175, 185  
 Dredges, PC.....175, 185  
 Dredges, S/S.....175, 185  
 Drip Trays.....41, 90  
 Dunnage Racks.....266  
 Dust Mop.....255

Dust Pan.....81, 255

**E**

Easels, Marker Board.....85, 100  
 Egg Poacher.....135  
 Egg Ring, S/S.....243  
 Egg Separator.....239  
 Egg Slicers.....239  
 Eraser, Marker Board.....85, 100

**F**

Fajita Servers.....54, 137  
 False Bottoms.....151  
 Fast Food Baskets.....63, 73  
 Fast Food Trays.....72  
 Faucet, Coffee Urn.....40, 86  
 Faucet, Juice Dispenser....41, 86  
 Faucets, Bev Dispenser.....87  
 Filter Cones, Fryer Stand....147, 243  
 First Aid Cabinet.....250  
 Fish Scaler, S/S.....241  
 Fish Spatula.....128-129, 226-227  
 Flair Bottle.....110  
 Flatware.....16-32  
 Flatware Cylinders.....81, 269  
 Floor Mats.....251  
 Floor Sweeper.....81, 255  
 Food Chopper.....196  
 Food Containers.....158, 253  
 Food Cooker/Warmer, Electric...280  
 Food Marker.....208, 240  
 Food Mill.....197  
 Food Pan Carriers, Insulated...274  
 Food Pan Covers, PC.....154  
 Food Pan, Divided.....34-36, 149  
 Food Pans.....34-38, 149  
 Food Pans, PC.....154  
**Food Portioners.....208, 214**  
**Food Portioners, NSF.....214**  
 Food Storage Box Covers, PC...155  
 Food Storage Boxes, PC.....155  
 Food Storage Boxes, PP.....155  
 Food Storage Covers, Rnd, PC...157  
 Food Storage Covers, Rnd, PP...157  
 Food Storage Covers, Sq, PE.....156, 208  
 Food Storage, Round, PC.....157  
 Food Storage, Round, PP.....157  
 Food Storage, Square, PC....156  
 Food Storage, Square, PP....156  
 Food Warmer, Electric.....39, 281  
 Fork, Pot.....44  
 Fork, Serving.....32  
 Forks, Basting.....217  
 Forks, Carving.....118, 242  
 Forks, Forged Cook's.....118, 242  
 Forks, Nylon.....222  
 Forks, Pot.....126, 242  
 French Fry Baggers.....147, 243  
 French Fry Cutters.....190, 193  
 French Fry Holder.....50  
 French Press.....51, 94  
 Frothing Pitchers.....94  
 Fruit Baskets, Wire.....63

Fruit/Vegetable Slicer.....191  
 Fry Basket Presses.....147  
 Fry Baskets.....147  
 Fry Baskets, Mini.....50  
 Fry Cups.....50  
 Fry Pan Sleeves.....144, 208  
**Fry Pan, Carbon Steel.....136**  
**Fry Pan, French Style.....136**  
 Fry Pans, Alu.....139  
 Fry Pans, Induction Ready...138  
 Fry Pans, S/S.....134  
 Fryer Filter.....147  
 Fryer Filter Stand.....147, 243  
 Fryer Pans.....147  
 Fryer Screen.....243  
 Fuel Holder.....34-38,  
 Funnel Strainers, S/S...174, 232, 262  
 Funnel, Confectionary..174, 206  
 Funnel, S/S.....174, 232, 262  
 Funnels, Plastic.....174, 232, 262  
 Funnels, Spun Alu.....174, 232

**G**

Garlic Press.....239  
 Gas Cooker, Portable.....281  
 Glass Polishing Towel.....114, 247, 256  
**Glass Rimmers.....103**  
 Glove Box Holder.....250  
 Gloves-Cotton, White.....80, 247, 250  
 Gloves, Cut Resistant.....127  
 Gloves, Latex.....250  
 Gloves, Mesh, S/S.....127, 241  
 Gloves, PE Textured.....250  
 Grapefruit Spoon.....29, 237  
 Grater, Box.....236  
 Graters.....75, 236  
 Graters, Cheese.....131, 235  
 Gravy Boats.....59  
 Gravy Ladle.....44  
 Gray Lug.....271  
 Griddle Holder.....259  
 Griddle Screen.....259  
 Griddle Screen Holder.....259  
 Griddle, Cast Iron.....137  
 Griddle, Hard Anodized, Alu....137  
 Griddles, Electric.....296  
 Griddles, Gas.....298  
 Grill Brick.....259  
 Grill Pan, Cast Iron.....137  
 Grinder.....53  
 Grippers, Pizza Pan.....183

**H**

Hamburger Press.....240  
 Handle Holders.....137, 248  
 Handles, Mop/Broom...254, 255  
 Hanger, Wine Glass.....113  
 Heat Lamp, Electric.....282  
**Heat Sink, Pizza.....188**  
 Herb Shears.....125, 238  
 High Chair Strap.....82  
**High Chairs.....82**  
 Holders, Knife.....126, 127  
 Hood Filters.....262  
 Hostess Sign.....83

Hot Dog Roller Grills.....294  
 Hot Plate Burners.....297  
 Hottle, Glass.....92

**I**

Ice Buckets.....111  
 Ice Caddy, Insulated....107, 273  
 Ice Chipper.....107  
**Ice Container.....107**  
 Ice Cream Cone Holder.....98  
 Ice Cream Scoopers, Alu....215  
 Ice Cream Dishers.....208, 215  
 Ice Cream Spade.....215  
 Ice Crusher.....106  
**Ice Cube Tray.....106**  
 Ice Pick.....107  
 Iced Tea Dispensers.....87  
 Induction Cooker.....281  
 Ingredient Bins.....158, 273  
 Insect Control.....262  
 Inserts, Condiment Holder...101  
 Inset Covers.....39, 152, 153  
 Inset Covers, Hinged.....39, 152  
**Insets.....39, 152-153**  
**Insets, NSF.....152**

**J**

**Japanese-style Jigger.....103**  
 Jar, Juice Dispenser.....41, 86  
 Jiggers.....103  
 Juice Dispensers.....41, 86  
 Juice Pour Bottles.....110  
 Juice Squeezers.....104  
 Juicer, Hand Squeeze..104, 237

**K**

Kattex.....190-192  
**Knife Bags.....127**  
 Knife Holder, Magnetic.....126  
 Knife Set.....119  
**Knife Sharpeners.....125**  
 Knife, Carving, S/S.....44  
**Knife, Nakiri.....116**  
**Knife, Peeling.....116**  
**Knife, Tomato.....116**  
 Knives, Boning.....116, 120, 122  
 Knives, Bread...118, 120, 123, 209  
 Knives, Cheese.....75, 131  
 Knives, Chef.....117, 121, 123, 209  
 Knives, Chopping.....130  
 Knives, Cimeter.....120, 121  
**Knives, Colored Hndls....122-123**  
 Knives, Cook's.....117, 121, 123  
**Knives, Hollow Ground.....116-118, 121, 123**  
 Knives, Oyster.....130, 235, 241  
 Knives, Paring.....116, 120, 122, 126, 209  
 Knives, Pizza.....130, 184  
 Knives, Santoku.....116, 121, 123  
**Knives, Short Bolster.....117**  
 Knives, Slicer.....118, 121  
**Knives, Stamped....120-123, 209**  
 Knives, Steak.....33, 132  
 Knives, Utility.....116, 120

**L**

**Ladles, One-Pc, S/S.....208, 212-213**



Ladle, Mini ..... 180, 213, 224  
 Ladle, Nylon ..... 222  
 Ladles, Black Hdl, NSF ..... 212  
 Ladles, Color-Coded ..... 208, 212-213  
 Ladles, Color-Coded, NSF ..... 212  
 Ladles, Measuring ..... 180, 213, 224  
 Ladles, One-Pc, S/S ..... 213  
 Ladles, PC ..... 46, 220  
 Ladles, Serving ..... 44  
 Ladles, Two-Pc, S/S ..... 213  
 LED Signs ..... 83  
 Lettuce Cutter ..... 192  
 Lettuce Knife ..... 238  
 Lids, Dredge, PC ..... 175, 185  
 Lids, Food Container ..... 107, 158, 253  
 Lids, Syrup Dispenser ..... 59, 233  
 Lids, Trash Can ..... 107, 158, 253  
 Liquor Pour Bottles ..... 110  
 Loaf Pans, Aluminized Steel ..... 164  
 Lobster Crackers ..... 76, 241  
 Lug Box Cart ..... 272

**M**

Magnetic Knife Holders ..... 126  
 Malt Cup ..... 102  
 Mandoline Slicers ..... 196  
 Marker Boards ..... 85, 100  
 Markers, Cake ..... 164  
 Markers, Neon ..... 85, 100  
 Masher, Nylon ..... 222  
 Mashers, Potato ..... 221  
 Mats, Bar ..... 113  
 Mats, Carpet Floor ..... 251  
 Mats, Cutting ..... 204-205  
 Mats, Floor, Rubber ..... 251  
 Mats, Service ..... 113  
 Measured Pourers ..... 108  
 Measures, Alu ..... 180, 225  
 Measuring Bowls, S/S ..... 180, 198  
 Measuring Cups, PC ..... 179, 225  
 Measuring Cups, Plastic ..... 180, 224  
 Measuring Cups, S/S ..... 180, 225  
 Measuring Spoons, PC ..... 180, 224  
 Measuring Spoons, S/S ..... 180, 224  
 Meat Tenderizers, Alu ..... 240  
 Melamine Collection ..... 64-65  
 Melon Baller ..... 235, 237  
 Menu Clips ..... 43, 68  
 Menu Covers ..... 66, 67  
 Microwaves ..... 290-291  
 Milk Cans, Mini ..... 51  
 Mint Julep Cups ..... 51, 102  
 Mini Cookware, Copper ..... 47, 48  
 Mini Cookware, S/S ..... 47, 48  
 Mini Serveware, S/S ..... 48, 49  
 Mini Taco Holders ..... 50  
 Mini Waste Can ..... 78  
 Mixing Bowl Stand ..... 198  
 Mixing Bowls ..... 198  
 Mixing Glass ..... 102  
 Mixing Paddles, Nylon ..... 179, 222  
 Mixing Paddles, S/S ..... 179, 222  
 Molds, Pastry ..... 171, 210

Mop Bucket ..... 254  
 Mop Heads ..... 254  
 Mortar & Pestle ..... 104, 197  
 Moscow Mule Mugs ..... 51, 102  
 Mounting Strap, Bar Speed Rail ..... 110  
 Muddlers ..... 104  
 Muffin Pans ..... 167  
 Mugs ..... 51, 65, 102  
 Mugs, Melamine ..... 65

**N**

Napkin Dispenser, S/S ..... 78  
 Non-Slip Trays ..... 70, 112  
 Nut Cracker ..... 76, 239, 241

**O**

Oil Can ..... 232  
 Oil Mop ..... 176  
 Onion Slicers ..... 191  
 Order Racks ..... 77  
 Oven Mitts ..... 177, 248  
 Ovens, Convection ..... 285  
 Oven, Pizza ..... 285  
 Overflow Pipes ..... 114, 262  
 Oyster Opener ..... 130, 235, 241

**P**

Paella Pans ..... 136  
 Pail Opener ..... 238, 262  
 Pail, Double ..... 256  
 Pails, Mini ..... 51  
 Pan Grabber ..... 144, 248  
 Pan, Omelet ..... 133  
 Pancake Dispenser ..... 174, 260  
 Panini Grills ..... 284  
 Paper Towel Dispenser ..... 260  
 Pasta Baskets ..... 146, 228  
 Pasta Cooker ..... 135, 145  
 Pasta Maker ..... 195  
 Pastry Bags ..... 169  
 Pastry Blenders ..... 173  
 Pastry Brushes, Nylon ..... 176  
 Pastry Mold ..... 171, 210  
 Pastry Wheel ..... 173  
 Peeler, Apple ..... 197  
 Peelers ..... 235  
 Peelers, Vegetable ..... 239  
 Peelers, Y ..... 235  
 Pepper Mill, Replacement Knob ..... 53  
 Pepper Mills ..... 53  
 Pepper Refiller ..... 57  
 Pestel, Wooden ..... 229  
 Pie Cutters ..... 165  
 Pie Plates ..... 165  
 Pie Server, S/S ..... 44  
 Pie Servers ..... 128-129, 226-227  
 Pineapple Corer ..... 237  
 Pitcher, Beer ..... 93  
 Pitcher, Syrup ..... 58  
 Pitchers, Bell ..... 92  
 Pitchers, Frothing ..... 94  
 Pitchers, PC ..... 93  
 Pitchers, S/S ..... 92  
 Pitchers, Water ..... 93  
 Pizza Bags ..... 81, 189, 273  
 Pizza Cutters ..... 130, 184, 235

Pizza Disk ..... 182  
 Pizza Knives ..... 130, 184  
 Pizza Oven ..... 285  
 Pizza Pan Grippers ..... 183  
 Pizza Pans ..... 181  
 Pizza Pans, Sicilian ..... 182  
 Pizza Pans, Stackable ..... 181  
 Pizza Peels, Alu ..... 184, 242  
 Pizza Peels, Wooden ..... 184  
 Pizza Poppers ..... 184  
 Pizza Screens ..... 183  
 Pizza Server ..... 185  
 Pizza Tongs ..... 185  
 Pizza Tray Rack ..... 183  
 Pizza Tray Stand ..... 183  
 Pizza Trays ..... 181  
 Plate, Salsa ..... 55  
 Plates, Melamine ..... 64  
 Plating Spoons ..... 211  
 Plating Tongs ..... 211  
 Platters, Melamine ..... 64  
 Platters, Oval, S/S ..... 54, 71  
 Platters, Sizzling ..... 54  
 Platters, Underliner ..... 54  
 Poly Woven Baskets ..... 62, 99  
 Popcorn Maker ..... 279  
 Pot Forks ..... 126, 242  
 Pot Holders ..... 248  
 Pot Hook ..... 134  
 Pot, Rice Cooker ..... 286  
 Potato Ricer ..... 221  
 Pourers ..... 108  
 Pourers, Flexible ..... 108  
 Pourers, Free Flow ..... 108  
 Pourers, Metal ..... 109  
 Pourers, Screened ..... 108  
 Powdered Sugar Strainer ..... 103, 175  
 Proofing Pans ..... 172, 186  
 Pump Kit ..... 110  
 Punch Bowl ..... 40, 86

**Q**

Quiche Pans ..... 165

**R**

Rack, Glass Hanger ..... 113  
 Rack, Icing/Cooling ..... 163  
 Rack, Knife ..... 126  
 Racks, Broom ..... 255  
 Racks, Cup Dispensing ..... 95  
 Racks, Cutting Board ..... 204  
 Racks, Mop ..... 255  
 Racks, Oil/Vinegar Cruet ..... 56  
 Racks, Order ..... 77  
 Racks, Seafood Tray ..... 61, 76, 97  
 Racks, Steamer ..... 163  
 Ramekins ..... 58  
 Refiller, Salt/Pepper ..... 57  
 Refrigerators ..... 278  
 Relish Servers ..... 60  
 Retarding Pans ..... 172, 186  
 Rice Cookers ..... 286  
 Rice Warmers ..... 286-287  
 Risers, Display ..... 42, 96  
 Roasting Pans, Alu ..... 143

Roasting Pans, Mini, S/S ..... 49  
 Roasting Pans, Mini, Copper ..... 49  
 Roll-Top Cover ..... 99, 150  
 Rolling Pins, Alu ..... 173, 187  
 Rolling Pins, French ..... 173, 187  
 Rolling Pins, Wooden ..... 173, 187  
 Rubber Scrap Block ..... 262

**S**

Salad Bowls ..... 61  
 Salad Spinners ..... 194  
 Salt Refiller ..... 57  
 Salt Shakers & Pepper Mills ..... 53  
 Sandwich Grills ..... 284  
 Sauce Cups, Melamine ..... 65  
 Sauce Cups, S/S ..... 58  
 Sauce Pans, S/S ..... 133, 137  
 Sauce Pots, Alu ..... 140-141, 144  
 Sauté Pans, Alu ..... 141  
 Sauté Pans, Induction ..... 138  
 Sauté Pans, S/S ..... 133  
 Scales ..... 194  
 Scoop Holder ..... 234  
 Scoop, Coffee ..... 94  
 Scoop, Ice ..... 234  
 Scoops, Alu ..... 234  
 Scoops, Flat Bottom, Alu ..... 234  
 Scoops, PC ..... 234  
 Scoops, Plastic ..... 234  
 Scoops, Utility, S/S ..... 234  
 Scouring Pads ..... 256  
 Scraper, Pizza Oven ..... 189, 258  
 Scrapers-Dough, Plastic ..... 172, 187, 207  
 Scrapers, Grill ..... 259  
 Scrapers, Plastic ..... 178, 223  
 Scrapers, S/S ..... 128-129, 226-227  
 Scrapers, Silicone ..... 178, 207, 223  
 Seafood Pick ..... 76, 241  
 Seafood Tray Racks ..... 61, 76, 97  
 Seafood Trays ..... 61, 76, 97  
 Serrator ..... 239  
 Server, Coffee, S/S ..... 91  
 Servers, Relish ..... 60  
 Serving Boards ..... 52  
 Serving Spoons, PC ..... 46, 220  
 Serving Trays, Chrome Plated ..... 43, 71  
 Serving Trays, Mini, S/S ..... 52  
 Set, Oil/Vinegar ..... 56  
 Shakers, Glass ..... 57  
 Sharpening Guide ..... 124  
 Sharpening Steel ..... 119, 124  
 Sharpening Stones ..... 124  
 Shears, Herbs ..... 125, 238  
 Shears, Kitchen ..... 125, 238  
 Shears, Poultry ..... 125, 238  
 Sheet Pan Covers ..... 161  
 Sheet Pan Extenders ..... 161  
 Sheet Pan Grates ..... 151  
 Sheet Pan Racks ..... 162-163, 267-268  
 Sheet Pans, Alu ..... 73, 143, 160  
 Sheet Pans, Alu, Perf ..... 160  
 Sheet Trays, Plastic ..... 160  
 Shelf Ingredient Bins ..... 158

Shelves, Wire, Chrome Plated ....	264	Squeeze Bottles.....74, 233	Tent Signs .....41, 90	Turners, High-Heat .....128
Shelves, Wire, Epoxy Coated ....	265	<b>Sugar Packet Holders, S/S .....59</b>	Thermometer, Frothing .....200	Turners, Serving.....242
Shelving Mats .....266		Stanchion Frame Signs.....83	Thermometer, Grill .....201	Turning Slicer .....197
Shelving Sets, Wire, Chrome		Stanchion Posts.....83	Thermometer, Infrared .....202	<b>U</b>
Plated .....263		Stanchion Signs.....83	Thermometer, Instant-Read 200	Underliners, Platter .....54, 137
Shelving Sets, Wire, Epoxy		Stand, Mixing Bowl.....198	Thermometers, Candy/Deep	Urinal Screen.....261
Coated .....263		Stand, Wine Bucket.....69, 111	Fryer.....201	Utility Cart Accessories.....272
Shelving, Accessories...264-266		Steak Knives .....33, 132	Thermometers, Digital .....202	Utility Carts.....272
Shelving, Brackets.....264-265		Steak Markers .....240	Thermometers, Digital,	Utility Pail .....206
Shelving, Extend Handle .....263		Steak Markers, Allergen-Free...208	Waterproof.....202	<b>W</b>
Shrimp Deveiner .....241		Steak Platter.....54, 137	Thermometers, Meat....200-201	Wall Bracket, Stanchion.....83
Sieves.....174		Steak Weights.....240	Thermometers, Oven.....200	<b>Waste Can, Mini .....78</b>
Sifter .....174, 188		<b>Steam Pan Cover .....99, 150</b>	Thermometers, Pocket Test .200	<b>Waste Receptacle.....252</b>
Sign, Reserved, S/S .....77		Steam Table Pan Covers .....150	Thermometers, Refrigerator/	Water Pans .....34-38, 149
Signs, Caution Floor .....254		Steam Table Pans,	Freezer.....201	Water Pitchers .....93
Signs, Information.....84		Anti-jamming.....148	Tiered Display Servers.....42, 96	Water Pitchers, Plastic .....93
Signs, Information, 3" x 9" .....84		<b>Steam Table Pans, GN .....148</b>	Timers.....177	Werving, Turner, S/S.....44
Signs, Information, 6" x 9" .....84		Steam Table Pans, Handles.....	Tip Tray .....77	Wheel, Mop Bucket .....254
Signs, Information, Braille.....84		38, 149	Toaster .....293	Whip, Kettle .....221
Signs, S/S Beverage.....41, 90		Steam Table Pans, Perforated ...	Toilet Paper Dispensers .....261	Whip, Mayonnaise.....221
Signs, Stanchion Frame.....83		149	Toilet Plunger.....261	Whips, French .....221
Signs, Wet Floor .....254		Steam Table Pans, Straight-	Toilet Seat Covers .....261	Whips, Piano .....221
Sink Strainer .....262		Sided.....34-38, 148	Toilet Tissue Holders .....261	Window Squeegee.....254
<b>Sizzle Platters Set .....54</b>		Steamer Baskets .....145	Tomato Corer .....235, 237	Wine Buckets .....69, 111
Skewers, Bamboo.....240		Steamer Racks .....163	Tomato Slicers.....190	Wine Coaster.....69, 111
Skewers, S/S .....240		Stir Fry Pans .....144	Tongs, Ice.....45, 107, 219	Wine Coolers .....69, 111
Skillets, Cast Iron.....137		Stirring Paddles.....179, 186, 222	Tongs, Flat, PC.....46, 220	Wine Service.....69, 111
Skimmers.....230		Stirring Spoons .....179, 222	Tongs, Pastry .....45, 219	Wiper Bracket Mount.....250
Snail Service.....60, 76		Stock Pot Covers, Alu.....	<b>Tongs, Pizza .....185</b>	Wire Cake Leveler .....165
Sneeze Guards.....295		138, 140-142	Tongs, Pom .....45, 219	<b>Wire Cart.....263</b>
Soap Dispenser .....260		Stock Pots, Alu .....140-142	Tongs, Salad.....45, 219	<b>Wire Cart, Trash Can.....253</b>
Soup Merchandisers.....276		Stock Pots, Induction Ready...138	Tongs, Scissor .....45, 219	<b>Wire Dolly .....159, 186, 268</b>
Soup Warmer, Electric.....287		Stock Pots, S/S.....133	Tongs, Serving.....44	<b>Wire Pan Grates.....151, 161</b>
Soup Warmers, S/S .....39		Strainer, Julep .....103	Tongs, Spaghetti, PC .....46, 220	Wok Covers, S/S.....136
Spaghetti Servers, S/S .....44		Strainers, Bouillon.....229	Tongs, Spaghetti, S/S.....45, 219	Wok Stand .....136
Spaghetti Tongs .....46, 220		Strainers, China Cap .....229	Tongs, Tweezer .....211	Woks.....136
Spatulas .....128-129, 226-227		Strainers, Mesh, S/S.....231	Tongs, Utility S/S.....45, 219, 208	<b>Wood Block Set .....119</b>
Spatulas, Bakery ....128-129, 168,		Strainers, Mesh, Tin .....231	Tongs, Utility, PC.....46, 220	Wringer, Mop Bucket .....254
209, 226-227		Strainers, Spaghetti.....230	Toothpick Dispenser.....78	<b>Z</b>
Spatulas, Grill.....		Straw Dispenser.....78, 101	<b>Tortilla Press.....55, 195</b>	Zester.....235
128-129, 226-227, 209		<b>Strip Heater.....283</b>	Tortilla Warmer.....55	
Spatulas, Nylon .....222		Stripe Herringbone Towel .....114, 247, 256	Tostada Basket .....147	
Spatulas, Offset.....		Sugar Bowl, S/S.....60	Towels .....114, 247, 256	
128-129, 226-227, 209		Sugar Dispenser, S/S.....175	Towels, Cleaning.....114, 247, 256	
Spatulas, S/S.....		Sugar Packet Holders, Plastic.....59	Trash Can.....252-253	
128-129, 226-227, 209		<b>Sweetener Packet Holder .....59</b>	Tray Stand.....70	
Spectrum.....290-299		<b>T</b>	Tray, Fiberglass, Trapezoid .....72	
Speed Rails.....110		Table Cloth Clip .....80, 247	Tray, Non-Slip Fiberglass...70, 112	
Spillage Pans .....149		Table Cloths .....80, 247	Trays, Cork.....70, 112	
Sponge, S/S.....256		Table Crumbers, Alu .....77	Trays, Display, S/S.....42, 96	
Spoon, Grapefruit.....29, 237		Table Number Holders .....68	Trays, Fiberglass, Market.....99	
Spoon, Wooden .....179, 222		Table Numbers, Plastic.....68	Trays, Fiberglass, Rectangular...72	
<b>Spoons, Basting.....216-217</b>		Table Sign Clips .....43, 68	Trays, Mess .....73	
<b>Spoons, Basting, NSF.....216</b>		Table Sign Holders .....43, 68	Trays, Rubber-Lined Easy Hold ...	
Spoons, Buffet, PC.....46, 220		Table Sign Holders, Acrylic....67	70, 112	
Spoons, Nylon.....179, 222		Table Sign Holders, Acrylic....67	Trays, Seafood .....61, 76, 97	
Spoons, Serving .....44		Table Wedge.....79	Trays, Serving Aluminum .....73	
Spoons, Serving, PC.....46, 220		Taco Basket.....147	Trays, Serving, Chrome Plated...43, 71	
Spoons, Serving, S/S.....44		Taco Holders, S/S .....50	Trays, Serving, S/S.....71, 112	
Spoons, Serving, Slotted S/S...44		Taco Salad Bowls.....147	Trolley, S/S.....272	
Spoons, Stirring .....179, 222		Taco Server .....50	Tumblers.....93	
Spray Bottle .....256		Tea Ball Infuser.....92	Turner, Pancake .....206, 242	
Springform Pans, Anodized Alu...166		Tea Light .....79	Turners.....128-129, 226-227, 209	
Squeegees.....254		Tea Lights, Rechargeable.....79	Turners, Cutting Edge .....128-129, 226-227, 209	
		Tea Pot, Gooseneck .....92		

**NOTES**

---

Lined area for notes, consisting of numerous horizontal lines spaced evenly down the page.



2017



DWL Industries Co.

---

**East Coast**

65 Industrial Road  
Lodi, NJ 07644

Tel. 1.888.946.2682  
Fax. 1.888.946.2632

**West Coast**

14950-14952 Valley View Ave  
La Mirada, CA 90638

Tel. 1.888.946.2652  
Fax. 1.562.926.5678

*Check your order status online at [www.wincous.com](http://www.wincous.com)*